

2004 Chevrolet Corvette Owner Manual

Seats and Restraint Systems	1-1	Driving Your Vehicle	4-1
Front Seats	1-2	Your Driving, the Road, and Your Vehicle	4-2
Safety Belts	1-6	Towing	4-33
Child Restraints	1-19	Service and Appearance Care	5-1
Air Bag System	1-40	Service	5-3
Restraint System Check	1-49	Fuel	5-4
Features and Controls	2-1	Checking Things Under the Hood	5-10
Keys	2-3	Rear Axle	5-47
Doors and Locks	2-9	Bulb Replacement	5-48
Windows	2-14	Windshield Wiper Blade Replacement	5-52
Theft-Deterrent Systems	2-16	Tires	5-55
Starting and Operating Your Vehicle	2-19	Appearance Care	5-82
Mirrors	2-37	Vehicle Identification	5-91
Storage Areas	2-40	Electrical System	5-92
Roof Panel	2-44	Capacities and Specifications	5-99
Convertible Top	2-50	Maintenance Schedule	6-1
Vehicle Personalization	2-57	Maintenance Schedule	6-2
Instrument Panel	3-1	Customer Assistance and Information	7-1
Instrument Panel Overview	3-2	Customer Assistance and Information	7-2
Climate Controls	3-23	Reporting Safety Defects	7-10
Warning Lights, Gages and Indicators	3-32	Index	1
Driver Information Center (DIC)	3-48		
Audio System(s)	3-69		



GENERAL MOTORS, GM, the GM Emblem, CHEVROLET, the CHEVROLET Emblem and the name CORVETTE and the CORVETTE Emblem are registered trademarks of General Motors Corporation.

This manual includes the latest information at the time it was printed. We reserve the right to make changes after that time without further notice. For vehicles first sold in Canada, substitute the name "General Motors of Canada Limited" for Chevrolet Motor Division whenever it appears in this manual.

Please keep this manual in your vehicle, so it will be there if you ever need it when you're on the road. If you sell the vehicle, please leave this manual in it so the new owner can use it.

Canadian Owners

You can obtain a French copy of this manual from your dealer or from:

Helm, Incorporated
P.O. Box 07130
Detroit, MI 48207

How to Use This Manual

Many people read their owner's manual from beginning to end when they first receive their new vehicle. If you do this, it will help you learn about the features and controls for your vehicle. In this manual, you will find that pictures and words work together to explain things.

Index

A good place to look for what you need is the Index in back of the manual. It is an alphabetical list of what is in the manual, and the page number where you will find it.

Safety Warnings and Symbols

You will find a number of safety cautions in this book. We use a box and the word CAUTION to tell you about things that could hurt you if you were to ignore the warning.

 **CAUTION:**

These mean there is something that could hurt you or other people.

In the caution area, we tell you what the hazard is. Then we tell you what to do to help avoid or reduce the hazard. Please read these cautions. If you don't, you or others could be hurt.



You will also find a circle with a slash through it in this book. This safety symbol means “Don’t,” “Don’t do this” or “Don’t let this happen.”

Vehicle Damage Warnings

Also, in this book you will find these notices:

Notice: These mean there is something that could damage your vehicle.

A notice will tell you about something that can damage your vehicle. Many times, this damage would not be covered by your warranty, and it could be costly. But the notice will tell you what to do to help avoid the damage.

When you read other manuals, you might see CAUTION and NOTICE warnings in different colors or in different words.

You'll also see warning labels on your vehicle. They use the same words, CAUTION or NOTICE.

































Vehicle Symbols

Your vehicle has components and labels that use symbols instead of text. Symbols, used on your vehicle, are shown along with the text describing the operation or information relating to a specific component, control, message, gage or indicator.

If you need help figuring out a specific name of a component, gage or indicator, reference the following topics:

- Seats and Restraint Systems in Section 1
- Features and Controls in Section 2
- Instrument Panel Overview in Section 3
- Climate Controls in Section 3
- Warning Lights, Gages and Indicators in Section 3
- Audio System(s) in Section 3
- Engine Compartment Overview in Section 5

These are some examples of symbols you may find on your vehicle:

CAUTION POSSIBLE INJURY		LATCH BOTH LAP AND SHOULDER BELTS TO PROTECT OCCUPANT DO NOT TWIST SAFETY BELT WHEN ATTACHING	 	MASTER LIGHTING SWITCH		ENGINE COOLANT TEMP		FUSE BOX ACCESS			
PROTECT EYES BY SHIELDING		FASTEN SEAT BELTS		AIR BAG		TURN SIGNALS		BATTERY CHARGING SYSTEM		ENGINE COOLANT FAN	
CAUSTIC BATTERY ACID COULD CAUSE BURNS		MOVE SEAT FULLY REARWARD SECURE CHILD SEAT		DO NOT INSTALL A REAR-FACING CHILD RESTRAINT IN THIS SEATING POSITION		PARKING LAMPS		BRAKE		FUEL	
AVOID SPARKS OR FLAMES		PULL BELT OUT COMPLETELY THEN SECURE CHILD SEAT		DO NOT INSTALL A FORWARD-FACING CHILD RESTRAINT IN THIS SEATING POSITION		HAZARD WARNING FLASHER		COOLANT		OWNER'S MANUAL	
SPARK OR FLAME COULD EXPLODE BATTERY		POWER WINDOW		DOOR LOCK UNLOCK		DAYTIME RUNNING LAMPS		ENGINE OIL PRESSURE		SERVICE	
						FOG LAMPS		ANTI-LOCK BRAKES		SERVICE MANUAL	

Model Reference

This manual covers these models:

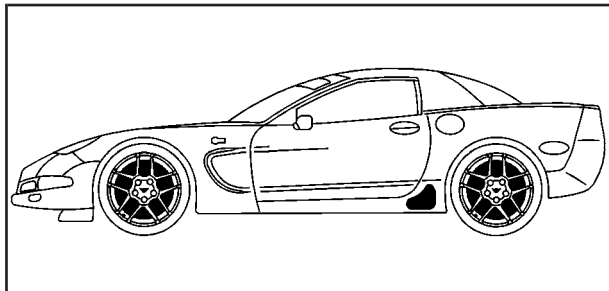

Z06

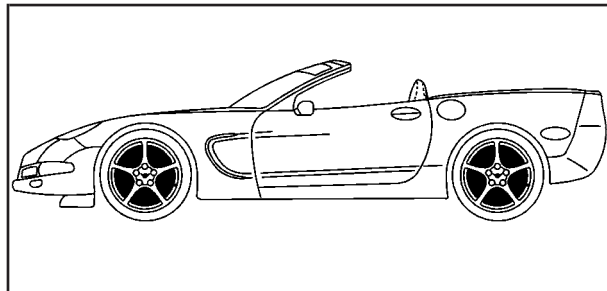

Convertible

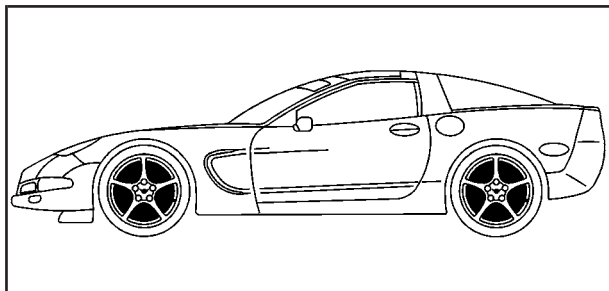

Coupe

Section 1 Seats and Restraint Systems

Front Seats	1-2	Lower Anchorages and Top Tethers for Children (LATCH System)	1-30
Manual Seats	1-2	Securing a Child Restraint Designed for the LATCH System	1-33
Power Seats	1-2	Securing a Child Restraint in the Passenger Seat Position	1-36
Reclining Seatbacks	1-3	Air Bag System	1-40
Seatback Latches	1-5	Where Are the Air Bags?	1-42
Sport Seat	1-6	When Should an Air Bag Inflate?	1-43
Safety Belts	1-6	What Makes an Air Bag Inflate?	1-43
Safety Belts: They Are for Everyone	1-6	How Does an Air Bag Restrain?	1-44
Questions and Answers About Safety Belts	1-11	What Will You See After an Air Bag Inflates?	1-44
How to Wear Safety Belts Properly	1-11	Air Bag Off Switch	1-46
Driver Position	1-12	Servicing Your Air Bag-Equipped Vehicle	1-49
Safety Belt Use During Pregnancy	1-18	Restraint System Check	1-49
Passenger Position	1-19	Checking Your Restraint Systems	1-49
Safety Belt Extender	1-19	Replacing Restraint System Parts After a Crash	1-50
Child Restraints	1-19		
Older Children	1-19		
Infants and Young Children	1-22		
Child Restraint Systems	1-25		
Top Strap	1-28		
Top Strap Anchor Location	1-30		

Front Seats

Manual Seats



To move a manual seat, pull up on the lever located in front of the seat to unlock it. Slide the seat to where you want it and release the lever. Then try to move the seat with your body to make sure the seat is locked into place.

Power Seats



If your vehicle has this feature, the control for the power seats will be located on the outboard side of each seat, near the base.

Different parts of the power seat control move different parts of the seat. To move the seat forward or rearward, move the control in that direction. Move the control up to raise the seat and down to lower it. By tilting the back of the control, it will raise or lower the back of the seat. Tilting the front of the control will raise or lower the front of the seat.

Your preferred seat position can be stored and recalled if you have the memory option. See *Memory on page 2-57*.

Reclining Seatbacks

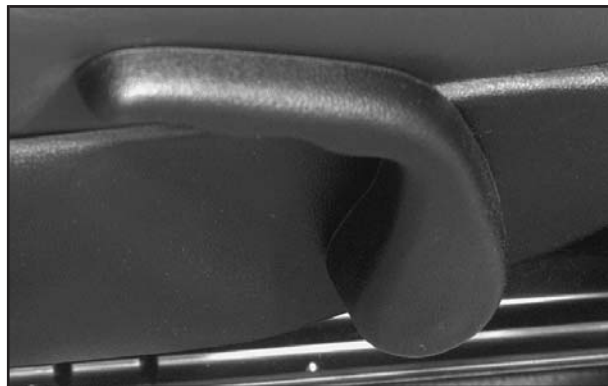

The lever for the reclining seatback is located on the outboard side of each seat, near the base.

To adjust the seatback, lean slightly forward to lift your weight off the seatback. Pull completely up on the lever until it stops, and lean back to position the seatback to where you want it. Release the lever to lock the seatback into place.



But do not have a seatback reclined if your vehicle is moving.

⚠ CAUTION:

Sitting in a reclined position when your vehicle is in motion can be dangerous. Even if you buckle up, your safety belts can't do their job when you're reclined like this.

The shoulder belt can't do its job because it won't be against your body. Instead, it will be in front of you. In a crash you could go into it, receiving neck or other injuries.

The lap belt can't do its job either. In a crash the belt could go up over your abdomen. The belt forces would be there, not at your pelvic bones. This could cause serious internal injuries.

For proper protection when the vehicle is in motion, have the seatback upright. Then sit well back in the seat and wear your safety belt properly.

Seatback Latches



Both seatbacks fold forward to give you access to the rear area. To fold a seatback forward, lift this latch, which is located on top of the backside of the seat, and pull the seatback forward. The seatback will lock down in this position.

To unlock, lift up on the latch and push the seatback rearward. When you return the seatback to its original position, make sure the seatback is locked in place.

CAUTION:

If the seatback isn't locked, it could move forward in a sudden stop or crash. That could cause injury to the person sitting there. Always press rearward on the seatback to be sure it is locked.

Sport Seat

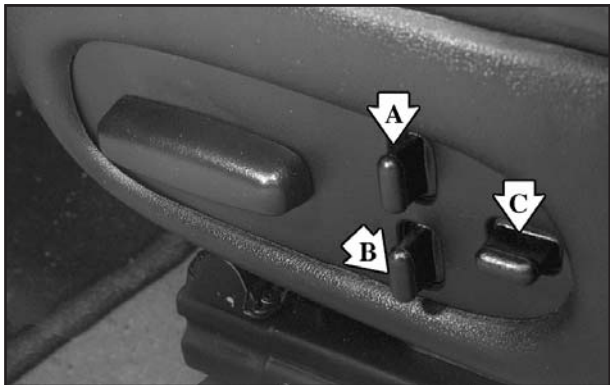

If your vehicle has this feature, there are three other controls that help you change the shape of the seat in addition to the power seat control. There are two lumbar supports for the middle (A) and lower (B) back. There is also a side bolster control (C) that adjusts the sides of the seat around you to give you more lateral support.

For lumbar support, move each control (A) and (B) forward to inflate or rearward to deflate.

Move the side bolster control (C) up for more side support and down for less support.

Safety Belts

Safety Belts: They Are for Everyone

This part of the manual tells you how to use safety belts properly. It also tells you some things you should not do with safety belts.

⚠ CAUTION:

Don't let anyone ride where he or she can't wear a safety belt properly. If you are in a crash and you're not wearing a safety belt, your injuries can be much worse. You can hit things inside the vehicle or be ejected from it. You can be seriously injured or killed. In the same crash, you might not be if you are buckled up. Always fasten your safety belt, and check that your passenger's belt is fastened properly too.

⚠ CAUTION:

It is extremely dangerous to ride in a cargo area, inside or outside of a vehicle. In a collision, people riding in these areas are more likely to be seriously injured or killed. Do not allow people to ride in any area of your vehicle that is not equipped with seats and safety belts. Be sure everyone in your vehicle is in a seat and using a safety belt properly.



Your vehicle has a light that comes on as a reminder to buckle up. See *Safety Belt Reminder Light* on page 3-34.

In most states and all Canadian provinces, the law says to wear safety belts. Here's why: *They work.*

You never know if you'll be in a crash. If you do have a crash, you don't know if it will be a bad one.

A few crashes are mild, and some crashes can be so serious that even buckled up a person wouldn't survive. But most crashes are in between. In many of them, people who buckle up can survive and sometimes walk away. Without belts they could have been badly hurt or killed.

After more than 30 years of safety belts in vehicles, the facts are clear. In most crashes buckling up does matter... a lot!

Why Safety Belts Work

When you ride in or on anything, you go as fast as it goes.

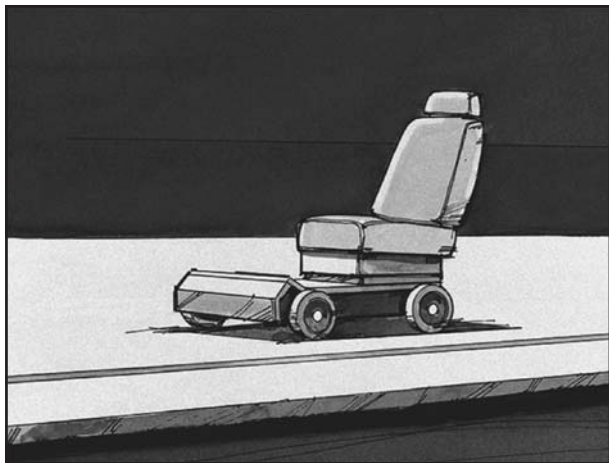

Take the simplest vehicle. Suppose it's just a seat on wheels.



Put someone on it.

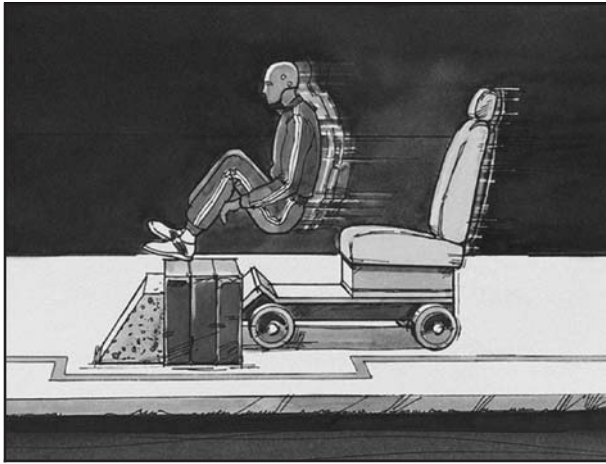

Get it up to speed. Then stop the vehicle. The rider doesn't stop.



The person keeps going until stopped by something. In a real vehicle, it could be the windshield...

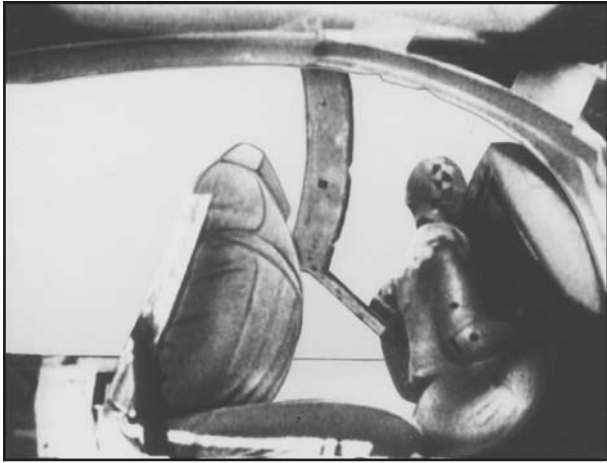

or the instrument panel...

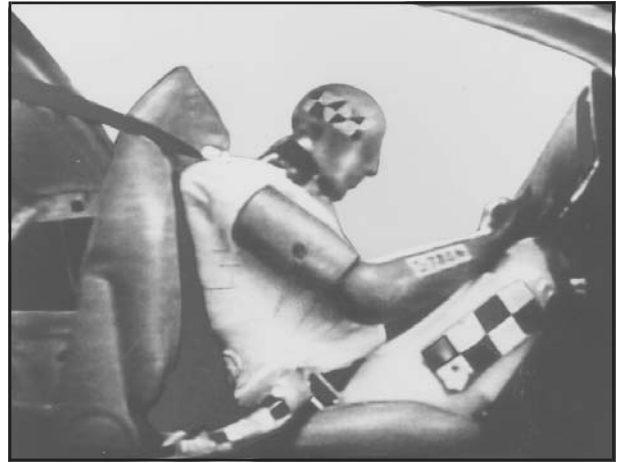

or the safety belts!

With safety belts, you slow down as the vehicle does. You get more time to stop. You stop over more distance, and your strongest bones take the forces. That's why safety belts make such good sense.

Questions and Answers About Safety Belts

Q: Won't I be trapped in the vehicle after an accident if I'm wearing a safety belt?

A: You *could* be — whether you're wearing a safety belt or not. But you can unbuckle a safety belt, even if you're upside down. And your chance of being conscious during and after an accident, so you *can* unbuckle and get out, is *much* greater if you are belted.

Q: If my vehicle has air bags, why should I have to wear safety belts?

A: Air bags are in many vehicles today and will be in most of them in the future. But they are supplemental systems only; so they work *with* safety belts — not instead of them. Every air bag system ever offered for sale has required the use of safety belts. Even if you're in a vehicle that has air bags, you still have to buckle up to get the most protection. That's true not only in frontal collisions, but especially in side and other collisions.

Q: If I'm a good driver, and I never drive far from home, why should I wear safety belts?

A: You may be an excellent driver, but if you're in an accident — even one that isn't your fault — you and your passenger can be hurt. Being a good driver doesn't protect you from things beyond your control, such as bad drivers.

Most accidents occur within 25 miles (40 km) of home. And the greatest number of serious injuries and deaths occur at speeds of less than 40 mph (65 km/h).

Safety belts are for everyone.

How to Wear Safety Belts Properly

This part is only for people of adult size.

Be aware that there are special things to know about safety belts and children. And there are different rules for smaller children and babies. If a child will be riding in your vehicle, see *Older Children on page 1-19* or *Infants and Young Children on page 1-22*. Follow those rules for everyone's protection.

First, you'll want to know which restraint systems your vehicle has.

We'll start with the driver position.

Driver Position

This part describes the driver's restraint system.

Lap-Shoulder Belt

The driver has a lap-shoulder belt. Here's how to wear it properly.

1. Close and lock the door.
2. Adjust the seat so you can sit up straight. To see how, see "Seats" in the Index.



3. Pick up the latch plate and pull the belt across you. Don't let it get twisted.

The lap-shoulder belt may lock if you pull the belt across you very quickly. If this happens, let the belt go back slightly to unlock it. Then pull the belt across you more slowly.

When the lap portion of the belt is pulled out all the way, it will lock. If it does, let it go back all the way and start again. See "Lap Belt Cinch Feature" later in this section.

4. Push the latch plate into the buckle until it clicks. Pull up on the latch plate to make sure it is secure. If the belt isn't long enough, see *Safety Belt Extender on page 1-19*.

Make sure the release button on the buckle is positioned so you would be able to unbuckle the safety belt quickly if you ever had to.

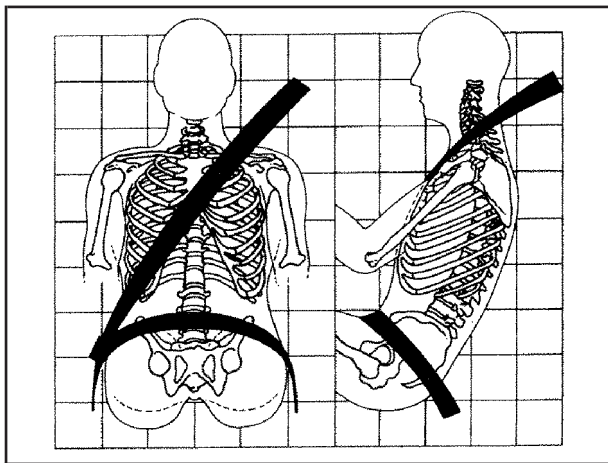

The lap part of the belt should be worn low and snug on the hips, just touching the thighs. In a crash, this applies force to the strong pelvic bones. And you'd be less likely to slide under the lap belt. If you slid under it, the belt would apply force at your abdomen. This could cause serious or even fatal injuries. The shoulder belt should go over the shoulder and across the chest. These parts of the body are best able to take belt restraining forces.

The safety belt locks if there's a sudden stop or crash, or if you pull the belt very quickly out of the retractor.

Lap Belt Cinch Feature

If you do not want the lap belt to move freely, pull the lap belt out all the way to set the lock. To permit the lap belt to move freely again, unbuckle the belt, let it retract all the way, and buckle up again.

Q: What's wrong with this?

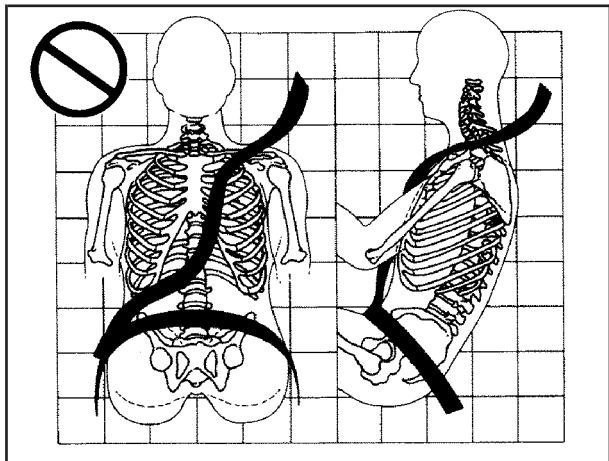

A: The shoulder belt is too loose. It won't give nearly as much protection this way.

⚠ CAUTION:

You can be seriously hurt if your shoulder belt is too loose. In a crash, you would move forward too much, which could increase injury. The shoulder belt should fit against your body.

Q: What's wrong with this?

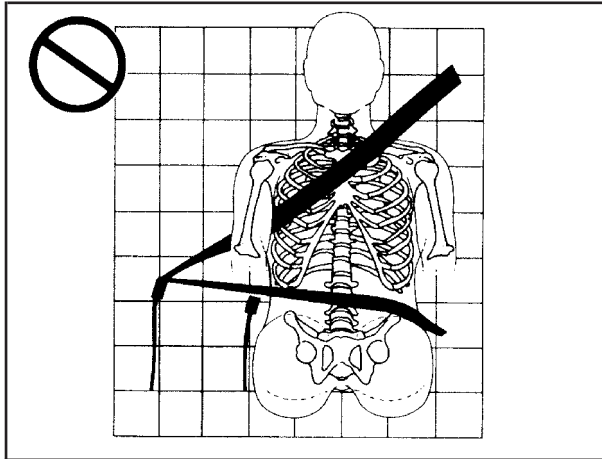

A: The belt is buckled in the wrong place.

⚠ CAUTION:

You can be seriously injured if your belt is buckled in the wrong place like this. In a crash, the belt would go up over your abdomen. The belt forces would be there, not at the pelvic bones. This could cause serious internal injuries. Always buckle your belt into the buckle nearest you.

Q: What's wrong with this?

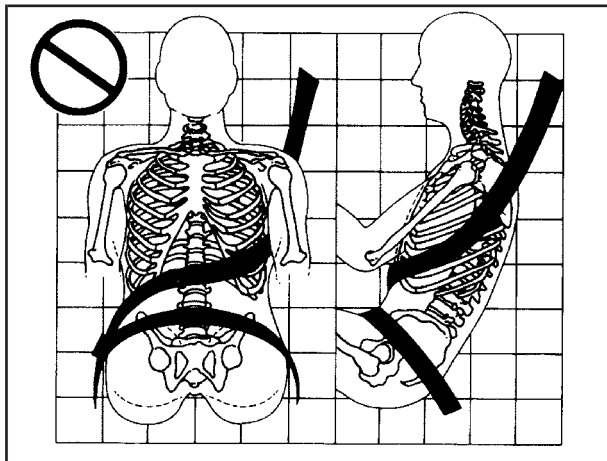

A: The shoulder belt is worn under the arm. It should be worn over the shoulder at all times.

⚠ CAUTION:

You can be seriously injured if you wear the shoulder belt under your arm. In a crash, your body would move too far forward, which would increase the chance of head and neck injury. Also, the belt would apply too much force to the ribs, which aren't as strong as shoulder bones. You could also severely injure internal organs like your liver or spleen.

Q: What's wrong with this?

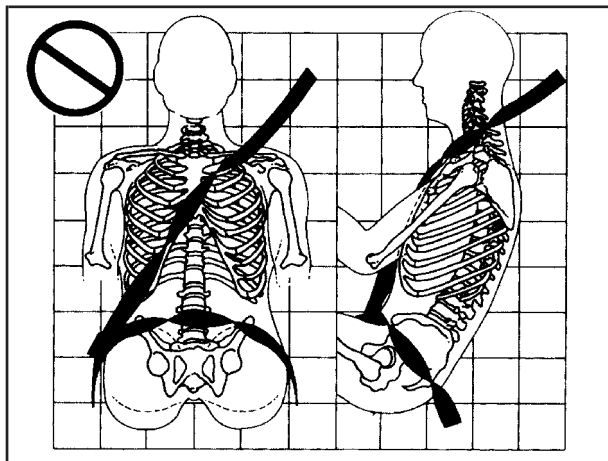

A: The belt is twisted across the body.

⚠ CAUTION:

You can be seriously injured by a twisted belt. In a crash, you wouldn't have the full width of the belt to spread impact forces. If a belt is twisted, make it straight so it can work properly, or ask your dealer to fix it.



To unlatch the belt, just push the button on the buckle. The belt should go back out of the way.

Before you close the door, be sure the belt is out of the way. If you slam the door on it, you can damage both the belt and your vehicle.

Safety Belt Use During Pregnancy

Safety belts work for everyone, including pregnant women. Like all occupants, they are more likely to be seriously injured if they don't wear safety belts.

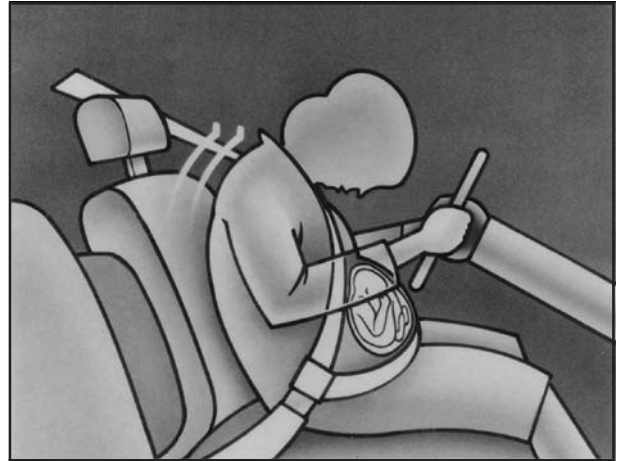

A pregnant woman should wear a lap-shoulder belt, and the lap portion should be worn as low as possible, below the rounding, throughout the pregnancy.

The best way to protect the fetus is to protect the mother. When a safety belt is worn properly, it's more likely that the fetus won't be hurt in a crash. For pregnant women, as for anyone, the key to making safety belts effective is wearing them properly.

Passenger Position

The passenger's safety belt works the same way as the driver's safety belt. See *Driver Position on page 1-12*.

Safety Belt Extender

If the vehicle's safety belt will fasten around you, you should use it.

But if a safety belt isn't long enough to fasten, your dealer will order you an extender. It's free. When you go in to order it, take the heaviest coat you will wear, so the extender will be long enough for you. The extender will be just for you, and just for the seat in your vehicle that you choose. Don't let someone else use it, and use it only for the seat it is made to fit. To wear it, just attach it to the regular safety belt.

Child Restraints

Older Children



Older children who have outgrown booster seats should wear the vehicle's safety belts.

Q: What is the proper way to wear safety belts?

A: If possible, an older child should wear a lap-shoulder belt and get the additional restraint a shoulder belt can provide. The shoulder belt should not cross the face or neck. The lap belt should fit snugly below the hips, just touching the top of the thighs. It should never be worn over the abdomen, which could cause severe or even fatal internal injuries in a crash.

In a crash, children who are not buckled up can strike other people who are buckled up, or can be thrown out of the vehicle. Older children need to use safety belts properly.



⚠ CAUTION:

Never do this.

Here two children are wearing the same belt. The belt can't properly spread the impact forces. In a crash, the two children can be crushed together and seriously injured. A belt must be used by only one person at a time.

Q: What if a child is wearing a lap-shoulder belt, but the child is so small that the shoulder belt is very close to the child's face or neck?

A: Move the child toward the center of the vehicle, but be sure that the shoulder belt still is on the child's shoulder, so that in a crash the child's upper body would have the restraint that belts provide.



⚠ CAUTION:

Never do this.

Here a child is sitting in a seat that has a lap-shoulder belt, but the shoulder part is behind the child. If the child wears the belt in this way, in a crash the child might slide under the belt. The belt's force would then be applied right on the child's abdomen. That could cause serious or fatal injuries.

The lap portion of the belt should be worn low and snug on the hips, just touching the child's thighs. This applies belt force to the child's pelvic bones in a crash.

Infants and Young Children

Everyone in a vehicle needs protection! This includes infants and all other children. Neither the distance traveled nor the age and size of the traveler changes the need, for everyone, to use safety restraints. In fact, the law in every state in the United States and in every Canadian province says children up to some age must be restrained while in a vehicle.

Every time infants and young children ride in vehicles, they should have the protection provided by appropriate restraints. Young children should not use the vehicle's adult safety belts alone, unless there is no other choice. Instead, they need to use a child restraint.



CAUTION:

People should never hold a baby in their arms while riding in a vehicle. A baby doesn't weigh much – until a crash. During a crash a baby will become so heavy it is not possible to hold it.

CAUTION: (Continued)

CAUTION: (Continued)

For example, in a crash at only 25 mph (40 km/h), a 12-lb. (5.5 kg) baby will suddenly become a 240-lb. (110 kg) force on a person's arms. A baby should be secured in an appropriate restraint.

 **CAUTION:**

Children who are up against, or very close to, any air bag when it inflates can be seriously injured or killed. Air bags plus lap-shoulder belts offer outstanding protection for adults and older children, but not for young children and infants. Neither the vehicle's safety belt system nor its air bag system is designed for them. Young children and infants need the protection that a child restraint system can provide.

Q: What are the different types of add-on child restraints?

A: Add-on child restraints, which are purchased by the vehicle's owner, are available in four basic types. Selection of a particular restraint should take into consideration not only the child's weight, height and age but also whether or not the restraint will be compatible with the motor vehicle in which it will be used.

For most basic types of child restraints, there are many different models available. When purchasing a child restraint, be sure it is designed to be used in a motor vehicle. If it is, the restraint will have a label saying that it meets federal motor vehicle safety standards.

The restraint manufacturer's instructions that come with the restraint state the weight and height limitations for a particular child restraint. In addition, there are many kinds of restraints available for children with special needs.

 **CAUTION:**

Newborn infants need complete support, including support for the head and neck. This is necessary because a newborn infant's neck is weak and its head weighs so much compared with the rest of its body. In a crash, an infant in a rear-facing seat settles into the restraint, so the crash forces can be distributed across the strongest part of an infant's body, the back and shoulders. Infants always should be secured in appropriate infant restraints.

 **CAUTION:**

The body structure of a young child is quite unlike that of an adult or older child, for whom the safety belts are designed. A young child's hip bones are still so small that the vehicle's regular safety belt may not remain low on the hip bones, as it should. Instead, it may settle up around the child's abdomen. In a crash, the belt would apply force on a body area that's unprotected by any bony structure. This alone could cause serious or fatal injuries. Young children always should be secured in appropriate child restraints.

Child Restraint Systems

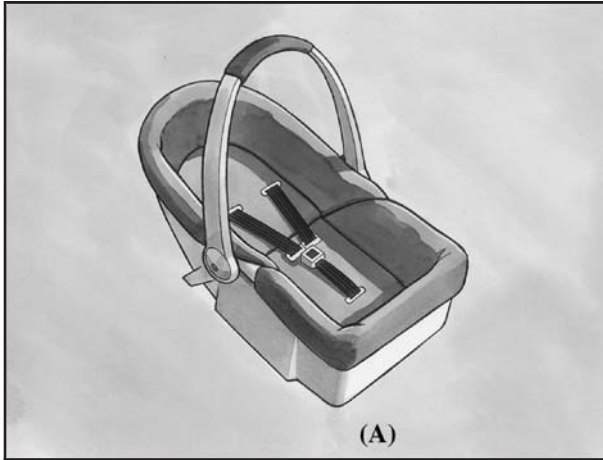

An infant car bed (A), a special bed made for use in a motor vehicle, is an infant restraint system designed to restrain or position a child on a continuous flat surface. Make sure that the infant's head rests toward the center of the vehicle.

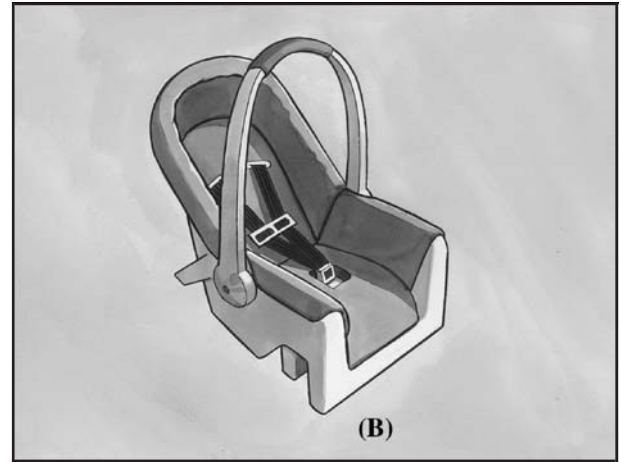

A rear-facing infant seat (B) provides restraint with the seating surface against the back of the infant. The harness system holds the infant in place and, in a crash, acts to keep the infant positioned in the restraint.

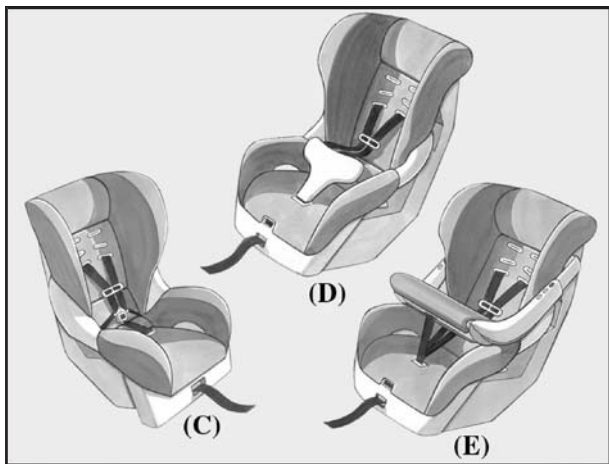

A forward-facing child seat (C-E) provides restraint for the child's body with the harness and also sometimes with surfaces such as T-shaped or shelf-like shields.

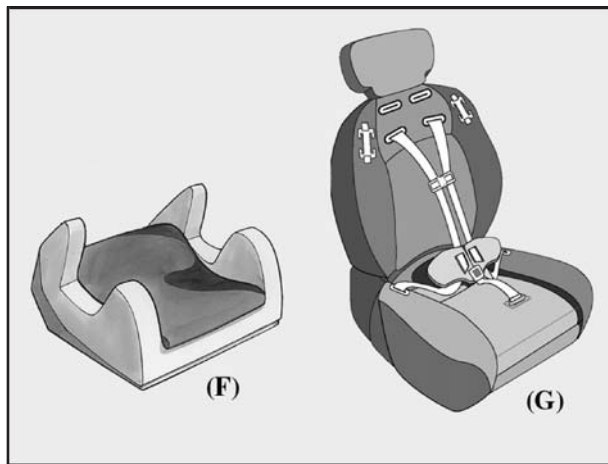

A booster seat (F-G) is a child restraint designed to improve the fit of the vehicle's safety belt system. Some booster seats have a shoulder belt positioner, and some high-back booster seats have a five-point harness. A booster seat can also help a child to see out the window.

Q: How do child restraints work?

A: A child restraint system is any device designed for use in a motor vehicle to restrain, seat, or position children. A built-in child restraint system is a permanent part of the motor vehicle. An add-on child restraint system is a portable one, which is purchased by the vehicle's owner.

For many years, add-on child restraints have used the adult belt system in the vehicle. To help reduce the chance of injury, the child also has to be secured within the restraint. The vehicle's belt system secures the add-on child restraint in the vehicle, and the add-on child restraint's harness system holds the child in place within the restraint.

One system, the three-point harness, has straps that come down over each of the infant's shoulders and buckle together at the crotch. The five-point harness system has two shoulder straps, two hip straps and a crotch strap. A shield may take the place of hip straps. A T-shaped shield has shoulder straps that are attached to a flat pad which rests low against the child's body. A shelf- or armrest-type shield has straps that are attached to a wide, shelf-like shield that swings up or to the side.

When choosing a child restraint, be sure the child restraint is designed to be used in a vehicle. If it is, it will have a label saying that it meets federal motor vehicle safety standards.

Then follow the instructions for the restraint. You may find these instructions on the restraint itself or in a booklet, or both. These restraints use the belt system in your vehicle, but the child also has to be secured within the restraint to help reduce the chance of personal injury. When securing an add-on child restraint, refer to the instructions that come with the restraint which may be on the restraint itself or in a booklet, or both, and to this manual. The child restraint instructions are important, so if they are not available, obtain a replacement copy from the manufacturer.

The child restraint must be secured properly in the passenger seat. If you want to secure a rear-facing child restraint in the passenger's seat, turn off the passenger's air bag. See *Air Bag Off Switch on page 1-46* and *Securing a Child Restraint in the Passenger Seat Position on page 1-36* for more on this, including important safety information.

 **CAUTION:**

A child in a rear-facing child restraint can be seriously injured or killed if the passenger's air bag inflates. This is because the back of the rear-facing child restraint would be very close to the inflating air bag. Be sure to turn off the air bag before using a rear-facing child restraint in the passenger seat position.

Keep in mind that an unsecured child restraint can move around in a collision or sudden stop and injure people in the vehicle. Be sure to properly secure any child restraint in your vehicle – even when no child is in it.

Top Strap

Some child restraints have a top strap, or “top tether.” It can help restrain the child restraint during a collision. For it to work, a top strap must be properly anchored to the vehicle. Some top strap-equipped child restraints are designed for use with or without the top strap being anchored. Others require the top strap always to be anchored. Be sure to read and follow the instructions for your child restraint. If yours requires that the top strap be anchored, do not use the restraint unless it is anchored properly.

If the child restraint does not have a top strap, one can be obtained, in kit form, for many child restraints. Ask the child restraint manufacturer whether or not a kit is available.

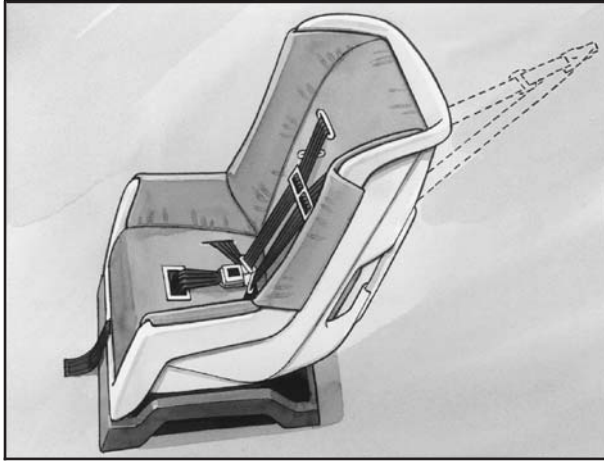

In Canada, the law requires that forward-facing child restraints have a top strap, and that the strap be anchored. In the United States, some child restraints also have a top strap. If your child restraint has a top strap, it should be anchored.

If your vehicle is a convertible or has a removable roof panel, do not use a child restraint that requires a top strap in your vehicle because the strap cannot be anchored properly.

Once you have the top strap anchored, you will be ready to secure the child restraint itself. Tighten the top strap when and as the child restraint manufacturer's instructions say.

Top Strap Anchor Location

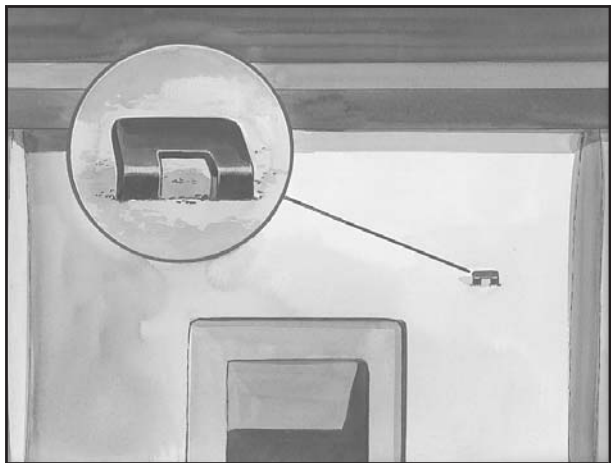

If your vehicle is a Z06, an anchor bracket for a top strap is located behind the passenger's seat in the cargo area. Anchor the top strap to the bracket.

If your vehicle is a convertible or has a removable roof panel, do not use a child restraint that requires a top strap in your vehicle because the top strap cannot be anchored properly.

Lower Anchorages and Top Tethers for Children (LATCH System)

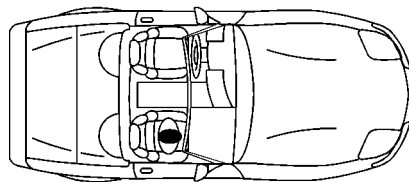

Your vehicle has the LATCH system. You will find anchors (A) for the passenger seat.

This system, designed to make installation of child restraints easier, does not use the vehicle's safety belts. Instead, it uses vehicle anchors (A,B) and child restraint attachments to secure the restraints. Some restraints also use another vehicle anchor to secure a top tether strap (C).

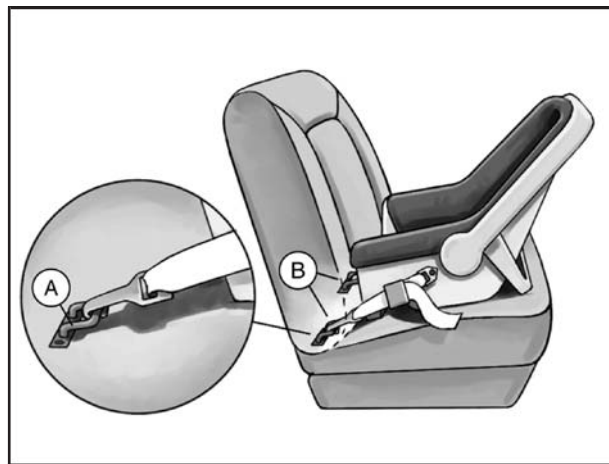
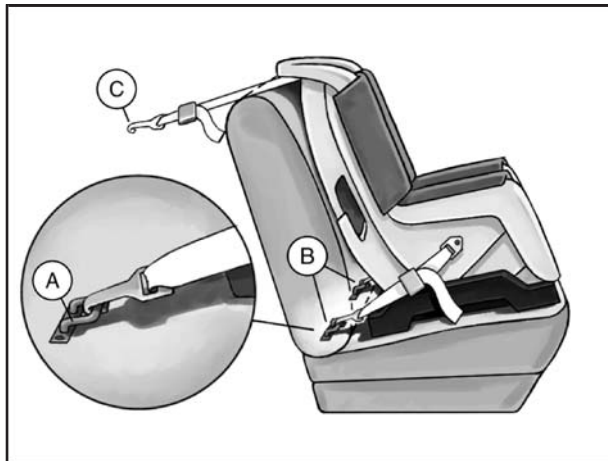

In order to use the LATCH system in your vehicle, you need a child restraint designed for that system.

To assist you in locating the lower anchors for this child restraint system, each seating position with the LATCH system has a label on the seatback at each lower anchor position.



The labels are located near the base of the passenger seat.

⚠ CAUTION:

If a LATCH-type child restraint is not attached to its anchorage points, the restraint will not be able to protect the child correctly. In a crash, the child could be seriously injured or killed. Make sure that a LATCH-type child restraint is properly installed using the anchorage points, or use the vehicle's safety belts to secure the restraint, following the instructions that came with that restraint, and also the instructions in this manual.

Securing a Child Restraint Designed for the LATCH System

Your vehicle has a passenger air bag. There is an air bag off switch in the glove box you can use to turn off the passenger's air bag when you need to secure a child restraint in the passenger position. See *Air Bag Off Switch* on page 1-46 for more on this including important safety information.

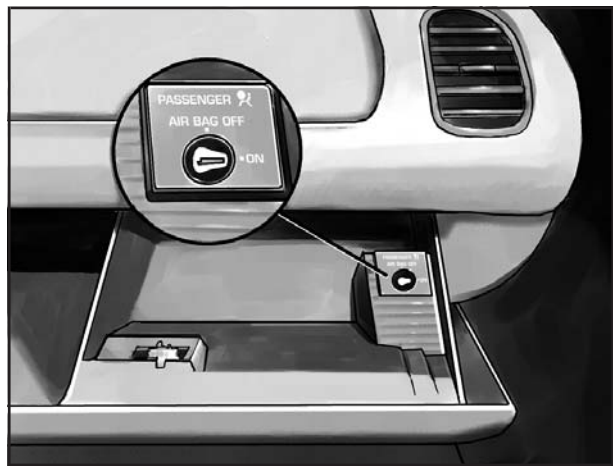

Unless the passenger's air bag has been turned off, *never* put a rear-facing child restraint in this vehicle.

Here is why:

CAUTION:

A child in a rear-facing child restraint can be seriously injured or killed if the passenger's air bag inflates. This is because the back of the rear-facing child restraint would be very close to the inflating air bag. Do not use a rear-facing child restraint in this vehicle unless the passenger's air bag has been turned off.

Even though the air bag off switch is designed to turn off the passenger's frontal air bag, no system is fail-safe, and no one can guarantee that an air bag will not deploy under some unusual circumstance, even though it is turned off. We recommend that rear-facing child restraints be transported in vehicles with a rear seat that will accommodate a rear-facing child restraint, whenever possible.

If you secure a forward-facing child restraint in the passenger seat, always move the passenger seat as far back as it will go.

CAUTION:

If the air bag readiness light ever comes on when you have turned off the air bag, it means that something may be wrong with the air bag system. The passenger's air bag could inflate even though the switch is off. If this ever happens, don't let anyone whom the national government has identified as a member of a passenger air bag risk group sit in the passenger's position (for example, don't secure a rear-facing child restraint in your vehicle) until you have your vehicle serviced. See "Air Bag Off Switch" in the Index.

If your vehicle is a convertible or has a removable roof panel, there are no top strap anchors in your vehicle. Do not secure a child seat in a convertible or a vehicle with a removable roof panel, if a national or local law requires that the top strap be anchored, or if the instructions that come with the restraint say that the top strap must be anchored.

1. Your vehicle has a passenger's air bag. See *Air Bag Off Switch* on page 1-46. If your child restraint is forward-facing, always move the seat as far back as it will go before securing it in this seat. See *Manual Seats* on page 1-2 or *Power Seats* on page 1-2. Never use a rear-facing child restraint in this seat unless the air bag is off.
2. Find the LATCH anchorages in the passenger seat. See *Lower Anchorages and Top Tethers for Children (LATCH System)* on page 1-30.
3. Put the child restraint on the seat.
4. Attach and tighten the LATCH attachments on the child restraint to the LATCH anchorages in the vehicle. The child restraint instructions will show you how.
5. If the child restraint is forward-facing, attach and tighten the top tether to the top tether anchorage if your vehicle has one. The child restraint instructions will show you how. Also see *Top Strap* on page 1-28.

6. Push and pull the child restraint in different directions to be sure it is secure.

To remove the child restraint, simply unhook the top tether from the top tether anchorage and then disconnect the LATCH anchorages.

Turn on the passenger's air bag when you remove the child restraint from the vehicle unless the person who will be sitting there is a member of a passenger air bag risk group. See *Air Bag Off Switch* on page 1-46.

 **CAUTION:**

If the passenger's air bag is turned off for a person who isn't in a risk group identified by the national government, that person won't have the extra protection of an air bag. In a crash, the air bag wouldn't be able to inflate and help protect the person sitting there. Don't turn off the passenger's air bag unless the person sitting there is in a risk group. See "Air Bag Off Switch" in the Index for more on this, including important safety information.

Securing a Child Restraint in the Passenger Seat Position

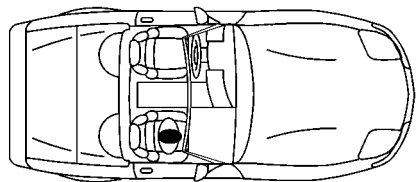

Your vehicle has a passenger air bag. There is an air bag off switch in the glove box you can use to turn off the passenger's air bag when you need to secure a child restraint in the passenger position. See *Air Bag Off Switch* on page 1-46 for more on this including important safety information.

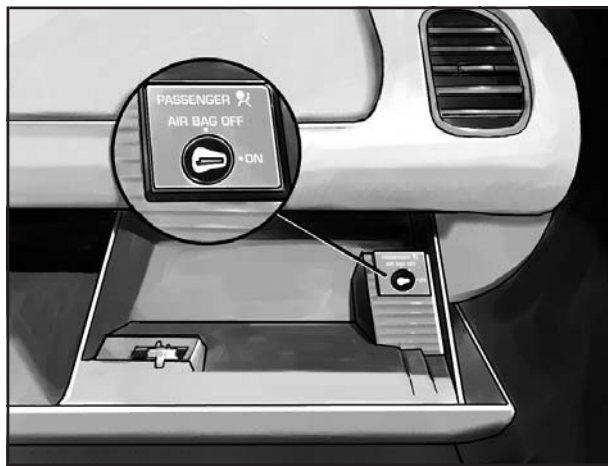

Unless the passenger's air bag has been turned off, *never* put a rear-facing child restraint in this vehicle.

Here is why:

 **CAUTION:**

A child in a rear-facing child restraint can be seriously injured or killed if the passenger's air bag inflates. This is because the back of the rear-facing child restraint would be very close to the inflating air bag. Do not use a rear-facing child restraint in this vehicle unless the passenger's air bag has been turned off.

Even though the air bag off switch is designed to turn off the passenger's frontal air bag, no system is fail-safe, and no one can guarantee that an air bag will not deploy under some unusual circumstance, even though it is turned off. We recommend that rear-facing child restraints be transported in vehicles with a rear seat that will accommodate a rear-facing child restraint, whenever possible.

If you secure a forward-facing child restraint in the passenger seat, always move the passenger seat as far back as it will go.

 **CAUTION:**

If the air bag readiness light ever comes on when you have turned off the air bag, it means that something may be wrong with the air bag system. The passenger's air bag could inflate even though the switch is off. If this ever happens, don't let anyone whom the national government has identified as a member of a passenger air bag risk group sit in the passenger's position (for example, don't secure a rear-facing child restraint in your vehicle) until you have your vehicle serviced. See "Air Bag Off Switch" in the Index.

If your child restraint is equipped with the LATCH system, see *Lower Anchorages and Top Tethers for Children (LATCH System)* on page 1-30. See *Top Strap* on page 1-28 if the child restraint has one.

If your vehicle is a convertible or has a removable roof panel, there are no top strap anchors in your vehicle. Do not secure a child seat in a convertible or a vehicle with a removable roof panel, if a national or local law requires that the top strap be anchored, or if the instructions that come with the restraint say that the top strap must be anchored.

If your child restraint does not have the LATCH system you will be using the lap-shoulder belt to secure the child restraint in this position. Be sure to follow the instructions that came with the child restraint. Secure the child in the child restraint when and as the instructions say.

1. Your vehicle has a passenger's air bag. See *Air Bag Off Switch* on page 1-46. If your child restraint is forward-facing, always move the seat as far back as it will go before securing it in this seat. See *Manual Seats* on page 1-2 or *Power Seats* on page 1-2. Never use a rear-facing child restraint in this seat unless the air bag is off.
2. Put the child restraint on the seat.

3. Pick up the latch plate, and run the lap and shoulder portions of the vehicle's safety belt through or around the restraint. The child restraint instructions will show you how.

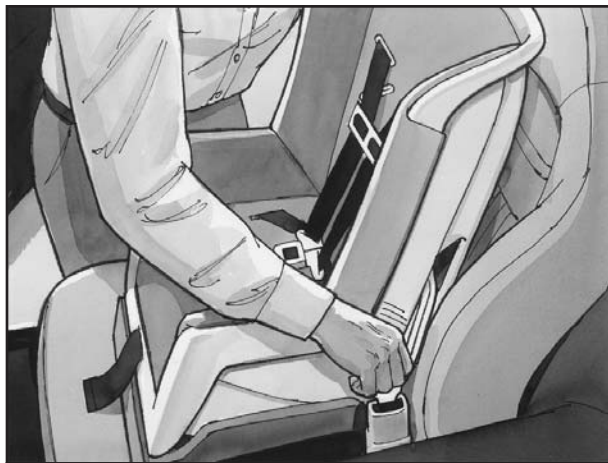

4. Buckle the belt. Make sure the release button is positioned so you would be able to unbuckle the safety belt quickly if you ever had to.



5. Pull the rest of the lap belt all the way out of the retractor to set the lock.



6. To tighten the belt, feed the lap belt back into the retractor while you push down on the child restraint. You may find it helpful to use your knee to push down on the child restraint as you tighten the belt.
7. Push and pull the child restraint in different directions to be sure it is secure.

To remove the child restraint, just unbuckle the vehicle's safety belt and let it go back all the way. The safety belt will move freely again and be ready to work for an adult or larger child passenger.

Turn on the passenger's air bag when you remove the child restraint from the vehicle unless the person who will be sitting there is a member of a passenger air bag risk group. See *Air Bag Off Switch* on page 1-46.

 **CAUTION:**

If the passenger's air bag is turned off for a person who isn't in a risk group identified by the national government, that person won't have the extra protection of an air bag. In a crash, the air bag wouldn't be able to inflate and help protect the person sitting there. Don't turn off the passenger's air bag unless the person sitting there is in a risk group. See "Air Bag Off Switch" in the Index for more on this, including important safety information.

Air Bag System

This part explains the air bag system.

Your vehicle has air bags – one air bag for the driver and another air bag for the passenger.

Frontal air bags are designed to help reduce the risk of injury from the force of an inflating air bag. But these air bags must inflate very quickly to do their job and comply with federal regulations.

Here are the most important things to know about the air bag system:

 **CAUTION:**

You can be severely injured or killed in a crash if you aren't wearing your safety belt — even if you have air bags. Wearing your safety belt during a crash helps reduce your chance of hitting things inside the vehicle or being ejected from it. Air bags are designed to work with safety belts, but don't replace them. Air bags are designed to deploy only in moderate to severe frontal and near frontal crashes.

CAUTION: (Continued)

CAUTION: (Continued)

They aren't designed to inflate at all in rollover, rear or low-speed frontal crashes, or in many side crashes. And, for some unrestrained occupants, air bags may provide less protection in frontal crashes than more forceful air bags have provided in the past. Everyone in your vehicle should wear a safety belt properly — whether or not there's an air bag for that person.

CAUTION:

Air bags inflate with great force, faster than the blink of an eye. If you're too close to an inflating air bag, as you would be if you were leaning forward, it could seriously injure you. Safety belts help keep you in position before and during a crash. Always wear your safety belt, even with air bags. The driver should sit as far back as possible while still maintaining control of the vehicle.

CAUTION:

Anyone who is up against, or very close to, any air bag when it inflates can be seriously injured or killed. Air bags plus lap-shoulder belts offer the best protection for adults, but not for young children and infants. Neither the vehicle's safety belt system nor its air bag system is designed for them. Young children and infants need the protection that a child restraint system can provide. Always secure children properly in your vehicle. To read how, see *Older Children on page 1-19* and *Infants and Young Children on page 1-22*.



There is an air bag readiness light on the instrument panel, which shows the air bag symbol.

The system checks the air bag electrical system for malfunctions. The light tells you if there is an electrical problem. See *Air Bag Readiness Light on page 3-35* for more information.

Where Are the Air Bags?



The driver's air bag is in the middle of the steering wheel.



The passenger's air bag is in the instrument panel on the passenger's side.

CAUTION:

If something is between an occupant and an air bag, the bag might not inflate properly or it might force the object into that person causing severe injury or even death. The path of an inflating air bag must be kept clear. Don't put anything between an occupant and an air bag, and don't attach or put anything on the steering wheel hub or on or near any other air bag covering.

When Should an Air Bag Inflate?

An air bag is designed to inflate in a moderate to severe frontal, or near-frontal crash. The air bag will inflate only if the impact speed is above the system's designed "threshold level." If your vehicle goes straight into a wall that does not move or deform, the threshold level is about 9 to 15 mph (14 to 24 km/h). The threshold level can vary, however, with specific vehicle design, so that it can be somewhat above or below this range.

If your vehicle strikes something that will move or deform, such as a parked car, the threshold level will be higher. The air bag is not designed to inflate in rollovers, rear impacts, or in many side impacts because inflation would not help the occupant.

In any particular crash, no one can say whether an air bag should have inflated simply because of the damage to a vehicle or because of what the repair costs were. Inflation is determined by the angle of the impact and how quickly the vehicle slows down in frontal or near-frontal impacts.

What Makes an Air Bag Inflate?

In an impact of sufficient severity, the air bag sensing system detects that the vehicle is in a crash. The sensing system triggers a release of gas from the inflator, which inflates the air bag. The inflator, air bag and related hardware are all part of the air bag modules inside the steering wheel and in the instrument panel in front of the passenger.

How Does an Air Bag Restrain?

In moderate to severe frontal or near-frontal collisions, even belted occupants can contact the steering wheel or the instrument panel. Air bags supplement the protection provided by safety belts. Air bags distribute the force of the impact more evenly over the occupant's upper body, stopping the occupant more gradually. But air bags would not help you in many types of collisions, including rollovers, rear impacts and many side impacts, primarily because an occupant's motion is not toward those air bags. Air bags should never be regarded as anything more than a supplement to safety belts, and then only in moderate to severe frontal or near-frontal collisions.

What Will You See After an Air Bag Inflates?

After the air bag inflates, it quickly deflates, so quickly that some people may not even realize the air bag inflated. Some components of the air bag module – the steering wheel hub for the driver's air bag, the instrument panel for the passenger's bag – will be hot for a short time. The parts of the bag that come into contact with you may be warm, but not too hot to touch. There will be some smoke and dust coming from the vents in the deflated air bags. Air bag inflation doesn't prevent the driver from seeing or being able to steer the vehicle, nor does it stop people from leaving the vehicle.

**CAUTION:**

When an air bag inflates, there is dust in the air. This dust could cause breathing problems for people with a history of asthma or other breathing trouble.

CAUTION: (Continued)

CAUTION: (Continued)

To avoid this, everyone in the vehicle should get out as soon as it is safe to do so. If you have breathing problems but can't get out of the vehicle after an air bag inflates, then get fresh air by opening a window or a door. If you experience breathing problems following an air bag deployment, you should seek medical attention.

In many crashes severe enough to inflate the air bag, windshields are broken by vehicle deformation. Additional windshield breakage may also occur from the passenger air bag.

- Air bags are designed to inflate only once. After an air bag inflates, you'll need some new parts for your air bag system. If you don't get them, the air bag system won't be there to help protect you in another crash. A new system will include air bag modules and possibly other parts. The service manual for your vehicle covers the need to replace other parts.

- Your vehicle is equipped with a diagnostic module, which records information about the air bag system. The module records information about the readiness of the system, when the system commands air bag inflation and driver's safety belt usage at deployment. The module also records speed, engine rpm, brake and throttle data.
- Let only qualified technicians work on your air bag systems. Improper service can mean that an air bag system won't work properly. See your dealer for service.

Notice: If you damage the covering for the driver's or the passenger's air bag, the bag may not work properly. You may have to replace the air bag module in the steering wheel or both the air bag module and the instrument panel for the passenger's air bag. Do not open or break the air bag coverings.

Air Bag Off Switch

Your vehicle has a switch in the glove box that you can use to turn off the passenger's air bag.

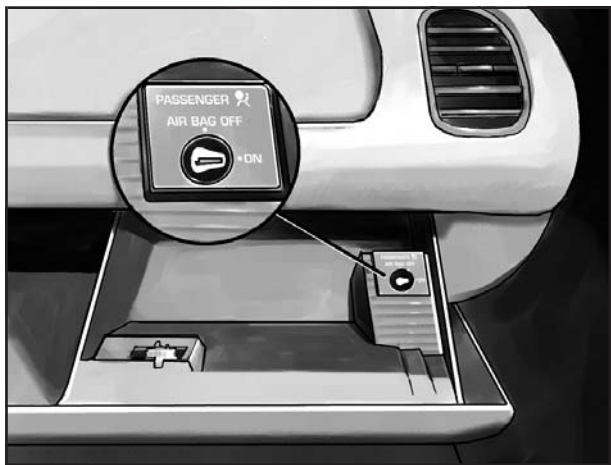

This switch should only be turned to AIR BAG OFF if the person in the passenger's position is a member of a passenger risk group identified by the national government as follows:

Infant. An infant (less than 1 year old) must ride in the front seat because:

- my vehicle has no rear seat;
- my vehicle has a rear seat too small to accommodate a rear-facing infant seat; or
- the infant has a medical condition which, according to the infant's physician, makes it necessary for the infant to ride in the front seat so that the driver can constantly monitor the child's condition.

Child age 1 to 12. A child age 1 to 12 must ride in the front seat because:

- my vehicle has no rear seat;
- although children ages 1 to 12 ride in the rear seat(s) whenever possible, children ages 1 to 12 sometimes must ride in the front because no space is available in the rear seat(s) of my vehicle; or
- the child has a medical condition which, according to the child's physician, makes it necessary for the child to ride in the front seat so that the driver can constantly monitor the child's condition.

Medical Condition. A passenger has a medical condition which, according to his or her physician:

- causes the passenger air bag to pose a special risk for the passenger; and
- makes the potential harm from the passenger air bag in a crash greater than the potential harm from turning off the air bag and allowing the passenger, even if belted, to hit the dashboard or windshield in a crash.

⚠ CAUTION:

If the passenger's air bag is turned off for a person who isn't in a risk group identified by the national government, that person won't have the extra protection of an air bag. In a crash, the air bag wouldn't be able to inflate and help protect the person sitting there. Don't turn off the passenger's air bag unless the person sitting there is in a risk group.



To turn off the passenger's air bag, insert your ignition key into the switch, push in, and move the switch to the off position.

The AIR BAG OFF light on the center console switch panel will come on to let you know that the passenger's air bag is off. The passenger's air bag will remain off until you turn it back on again, and the AIR BAG OFF light will stay on to remind you that the air bag is off.

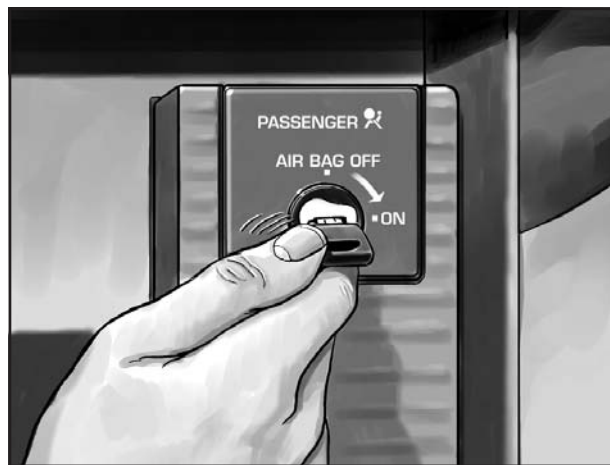

To turn the passenger's air bag on again, insert your ignition key into the switch, push in, and move the switch to the on position.

Servicing Your Air Bag-Equipped Vehicle

Air bags affect how your vehicle should be serviced. There are parts of the air bag system in several places around your vehicle. You don't want the system to inflate while someone is working on your vehicle. Your dealer and the service manual have information about servicing your vehicle and the air bag system. To purchase a service manual, see *Service Publications Ordering Information on page 7-11*.

CAUTION:

For up to 10 seconds after the ignition key is turned off and the battery is disconnected, an air bag can still inflate during improper service. You can be injured if you are close to an air bag when it inflates. Avoid yellow wires, wires wrapped with yellow tape or yellow connectors. They are probably part of the air bag system. Be sure to follow proper service procedures, and make sure the person performing work for you is qualified to do so.

The air bag system does not need regular maintenance.

Restraint System Check

Checking Your Restraint Systems

Now and then, make sure the safety belt reminder light and all your belts, buckles, latch plates, retractors and anchorages are working properly. Look for any other loose or damaged safety belt system parts. If you see anything that might keep a safety belt system from doing its job, have it repaired.

Torn or frayed safety belts may not protect you in a crash. They can rip apart under impact forces. If a belt is torn or frayed, get a new one right away.

Also look for any opened or broken air bag covers, and have them repaired or replaced. (The air bag system does not need regular maintenance.)

Replacing Restraint System Parts After a Crash

CAUTION:

A crash can damage the restraint systems in your vehicle. A damaged restraint system may not properly protect the person using it, resulting in serious injury or even death in a crash. To help make sure your restraint systems are working properly after a crash, have them inspected and any necessary replacements made as soon as possible.

If you've had a crash, do you need new belts?

After a very minor collision, nothing may be necessary. But if the belts were stretched, as they would be if worn during a more severe crash, then you need new parts.



If you ever see a label on the driver's safety belt that says to replace the belt, be sure to do so. Then the new belt will be there to help protect you in a collision. You would see this label on the belt near the latch plate.

If belts are cut or damaged, replace them. Collision damage also may mean you will need to have safety belt or seat parts repaired or replaced. New parts and repairs may be necessary even if the belt wasn't being used at the time of the collision.

If an air bag inflates, you'll need to replace air bag system parts. See the part on the air bag system earlier in this section.

Section 2 Features and Controls

Keys	2-3	Ignition Positions	2-20
Remote Keyless Entry System	2-5	Starting Your Engine	2-21
Remote Keyless Entry System Operation	2-6	Engine Coolant Heater	2-23
Doors and Locks	2-9	Automatic Transmission Operation	2-25
Door Locks	2-9	Manual Transmission Operation	2-28
Power Door Locks	2-10	Parking Brake	2-31
Lockout Protection	2-10	Shifting Into Park (P)	2-32
Leaving Your Vehicle	2-10	Shifting Out of Park (P)	2-34
Hatch/Trunk	2-11	Parking Your Vehicle (Manual Transmission)	2-35
Windows	2-14	Parking Over Things That Burn	2-35
Power Windows	2-15	Engine Exhaust	2-36
Sun Visors	2-15	Running Your Engine While You Are Parked (Automatic Transmission)	2-36
Theft-Deterrent Systems	2-16	Mirrors	2-37
Theft-Deterrent System	2-16	Manual Rearview Mirror	2-37
PASS-Key®	2-18	Automatic Dimming Rearview Mirror	2-38
Starting and Operating Your Vehicle	2-19	Outside Power Heated Mirrors	2-38
New Vehicle Break-In	2-19	Outside Automatic Dimming Mirror	2-39
Front Air Dam	2-19	Outside Convex Mirror	2-39

Section 2 Features and Controls

Storage Areas	2-40	Roof Panel	2-44
Glove Box	2-40	Removing the Roof Panel	2-44
Cupholder(s)	2-40	Storing the Roof Panel	2-47
Center Console Storage Area	2-40	Installing the Roof Panel	2-49
Floor Mats	2-41	Convertible Top	2-50
Rear Storage Area	2-42	Lowering the Convertible Top	2-51
Convenience Net	2-43	Raising the Convertible Top	2-55
Cargo Cover	2-43	Vehicle Personalization	2-57
		Memory	2-57

Keys

CAUTION:

Leaving children in a vehicle with the ignition key is dangerous for many reasons. They could operate the power windows or other controls or even make the vehicle move. The children or others could be badly injured or even killed. Do not leave the keys in a vehicle with children.



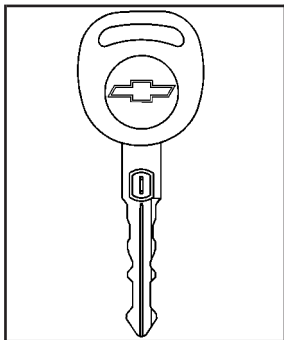

One key is used for the ignition, the driver's door and all other locks.

When a new vehicle is delivered, the dealer gives the first owner a key and a bar coded tag. Both the key and the tag are attached to a key ring.

The paper tag has a code on it that tells your dealer or a qualified locksmith how to make an extra key. Keep the bar-coded tag in a safe place. If you lose your key, you'll be able to have a new one made easily using this tag. If your key doesn't have a tag and you need a new ignition key, go to your dealer for the correct key code.

Notice: If you ever lock your keys in your vehicle, you may have to damage the vehicle to get in. Be sure you have spare keys.

If you ever do get locked out of your vehicle, call Chevrolet Roadside Assistance. See *Roadside Assistance Program* on page 7-6 for more information.

Remote Keyless Entry System

Your vehicle has a Remote Keyless Entry (RKE) system that operates on a radio frequency subject to Federal Communications Commission (FCC) Rules and with Industry Canada.

This device complies with Part 15 of the FCC Rules. Operation is subject to the following two conditions:
(1) this device may not cause harmful interference, and
(2) this device must accept any interference received, including interference that may cause undesired operation.

This device complies with RSS-210 of Industry Canada. Operation is subject to the following two conditions:
(1) this device may not cause interference, and
(2) this device must accept any interference received, including interference that may cause undesired operation of the device.

Changes or modifications to this system by other than an authorized service facility could void authorization to use this equipment.

If you ever notice a decrease in the remote keyless entry transmitter range, try doing one of the following:

- Check the distance. You may be too far from your vehicle. You may need to stand closer during rainy or snowy weather.
- Check the location. Other vehicles or objects may be blocking the signal. Take a few steps to the left or right, hold the transmitter higher, and try again.
- Check to determine if battery replacement is necessary. See “Battery Replacement” under *Remote Keyless Entry System Operation on page 2-6*.
- Check to make sure that an electronic device such as a cellular phone or lap top computer is not causing interference.
- If you’re still having trouble, see your dealer or a qualified technician for service.

Remote Keyless Entry System Operation

Your vehicle has a Remote Keyless Entry (RKE) system that allows you to lock and unlock your doors, unlock your hatch/trunk lid, turn the panic alarm on and off and disarm or arm your theft-deterrent system. The range distance is as much as 100 feet (30 m) away.



Your vehicle comes standard with two transmitters, and up to three can be matched to your vehicle.

See “Matching Transmitter(s) to Your Vehicle” later in this section.

The driver’s door will unlock when the unlock button on the remote keyless entry transmitter is pressed, or press the unlock button again within five seconds to unlock both doors. Also, by pressing the unlock button, it may automatically disarm your theft-deterrent system, depending on how the theft-deterrent system is programmed. If it is dark enough outside, your interior lamps will come on.

Your memory settings will also be recalled when you press the unlock button on the remote keyless entry transmitter. See *Memory on page 2-57* for more information.

The hatch/trunk lid will release when the button with the trunk symbol is pressed, as long as the ignition is turned to OFF.

The system has a feature that makes it difficult for you to lock your key in your vehicle. If you leave your key *in the ignition* and attempt to lock the doors, the vehicle will not lock and a chime will sound to remind you that the key is in the ignition. If the door lock is pressed again, within five seconds, the doors will lock and the keys can be locked in the vehicle. This system cannot guarantee that you will never be locked out of your vehicle. Always remember to take your key with you.

Remote Alarm

When you press the horn button on the remote keyless entry transmitter, the horn will sound. This panic alarm button will allow you to attract attention, if needed.

If the horn alarm sounds, there are three ways to turn it off:

- Press the panic alarm button again on the remote keyless entry transmitter.
- Wait 90 seconds, and the horn will turn off by itself.
- Turn the key to any position in the ignition, except OFF.

Remote Keyless Entry Settings

You can adjust the settings on the system through the Driver Information Center (DIC). You can change the type of alarm used by the theft-deterrent system. See *DIC Controls and Displays on page 3-49* for more information.

Matching Transmitter(s) to Your Vehicle

Each remote keyless entry transmitter is coded to prevent another transmitter from unlocking your vehicle. If a transmitter is lost or stolen, a replacement can be purchased through your dealer. Remember to bring any remaining transmitters with you when you go to your dealer. When the dealer matches the replacement transmitter to your vehicle, any remaining transmitters must also be matched. Once your dealer has coded the new transmitter, the lost transmitter will not unlock your vehicle. Each vehicle can have a maximum of three transmitters matched to it.

To match transmitters to your vehicle, do the following:

1. Turn the ignition key to ON.
2. Clear any warning messages on the Driver Information Center (DIC) by pressing the RESET button.
3. Press the OPTIONS button on the DIC several times until the blank page is displayed, then press and hold the RESET button for two seconds.
4. When the message FOB TRAINING is displayed, press the RESET button once. The message HOLD LK + UNLK 1ST FOB will be displayed in the DIC.

5. Press and hold the lock and unlock buttons on the first transmitter simultaneously for five seconds.
6. When a transmitter is learned (matched), the DIC will display FOB LEARNED and then prompt you to learn the second transmitter.
7. Repeat Steps 5 and 6 for the third transmitter.
8. Remove the key from the ignition.

The programming mode will shut off if any of following has occurred:

- You do not program any transmitters for two minutes.
- You take the key out of the ignition.
- You have programmed three transmitters.

Battery Replacement

Under normal use, the battery in your remote keyless entry transmitter should last about three years.

You can tell the battery is weak if the transmitter will not work at the normal range in any location. If you have to get close to your vehicle before the transmitter works, it is probably time to change the battery.

Notice: When replacing the battery, use care not to touch any of the circuitry. Static from your body transferred to these surfaces may damage the transmitter.



1. Insert a coin or similar object into the slot on the back of the transmitter and gently pry apart the front and back.
2. Gently pull the battery out of the transmitter.
3. Put the new battery in the transmitter, positive (+) side up. Use a battery, type CR2032, or equivalent.
4. Reassemble the transmitter. Make sure to put it together so water will not get in.
5. Test the transmitter.

Doors and Locks

Door Locks

CAUTION:

Unlocked doors can be dangerous.

- Passengers — especially children — can easily open the doors and fall out of a moving vehicle. When a door is locked, the handle will not open it. You increase the chance of being thrown out of the vehicle in a crash if the doors are not locked. So, wear safety belts properly and lock the doors whenever you drive.
- Young children who get into unlocked vehicles may be unable to get out. A child can be overcome by extreme heat and can suffer permanent injuries or even death from heat stroke. Always lock your vehicle whenever you leave it.
- Outsiders can easily enter through an unlocked door when you slow down or stop your vehicle. Locking your doors can help prevent this from happening.

There are several ways to lock and unlock your vehicle.

To lock or unlock the door from the outside, use your door key on the drivers's side or the remote keyless entry transmitter.

If your theft-deterrent system is armed, unlock the driver's door with the key or by using the remote keyless entry transmitter to open either door to avoid setting off the alarm. See *Theft-Deterrent System on page 2-16*.



To lock the door from the inside, move the lever located on the door forward. To unlock it, move the lever on the door rearward.

Power Door Locks

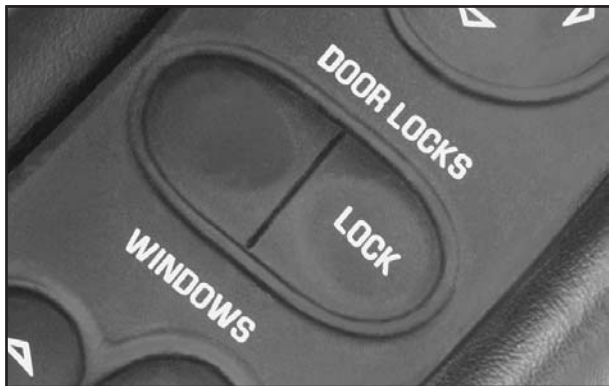

Press the power door switch on either door to unlock or lock both doors at once.

Lockout Protection

If you press the power door lock switch when a door is open and a key is in the ignition, a chime will sound. If the power door lock switch is pressed again within five seconds, the doors will lock.

Leaving Your Vehicle

If you are leaving the vehicle, take your key, open your door and set the locks from inside or with the remote keyless entry transmitter. Then get out and close the door.

Hatch/Trunk

CAUTION:

It can be dangerous to drive with the hatch/trunk lid open because carbon monoxide (CO) gas can come into your vehicle. You can not see or smell CO. It can cause unconsciousness and even death. If you must drive with the hatch/trunk lid open or if electrical wiring or other cable connections must pass through the seal between the body and the hatch/trunk lid:

- Make sure all other windows are shut.
- Turn the fan on your heating or cooling system to its highest speed and select the control setting that will force outside air into your vehicle. See *Dual Automatic Climate Control System* on page 3-23.
- If you have air outlets on or under the instrument panel, open them all the way.

See *Engine Exhaust* on page 2-36.

Notice: Closing the hatch/trunk lid forcefully or from the sides can cause damage to the glass, the defogger or the weather stripping. Be sure objects will fit in the hatch/trunk area before closing the hatch/trunk lid. When closing the hatch/trunk lid, gently pull down from the center.

Notice: Do not store heavy or sharp objects in the rear storage compartments located in the hatch/trunk area. If you do, the objects could damage the underbody.

Hatch/Trunk Lid Release



To use the hatch/trunk lid release on vehicles with an automatic transmission, your vehicle must be in PARK (P) or NEUTRAL (N). For manual transmissions, set the parking brake. See *Parking Brake* on page 2-31.

Press the button with the trunk symbol on it, located at the left side of the steering column on the instrument panel, to release the hatch/trunk lid from inside your vehicle.

The remote keyless entry transmitter will also release the hatch/trunk lid. See *Remote Keyless Entry System* on page 2-5.

If your vehicle is equipped with a hatch and you have lost battery power, use the manual release cables to open the hatch. To access the cables, remove the two access panels located in the rear of the trunk area. There is one cable located under each access panel. See *Rear Storage Area* on page 2-42 for more information.



Pull each cable straight down for each latch to release the hatch.

If your vehicle is equipped with a convertible top/hardtop and you have lost battery power, use the manual release cable to open the trunk lid. To access the cable, remove the center storage compartment lid located in the rear of the trunk area. See *Rear Storage Area* on page 2-42 for more information.



Pull the cable straight down to release the trunk lid.
If your vehicle is equipped with a convertible top and trunk release handle and you have lost battery power, use the trunk release handle to open the trunk.

Emergency Trunk Release Handle (Convertible Only)

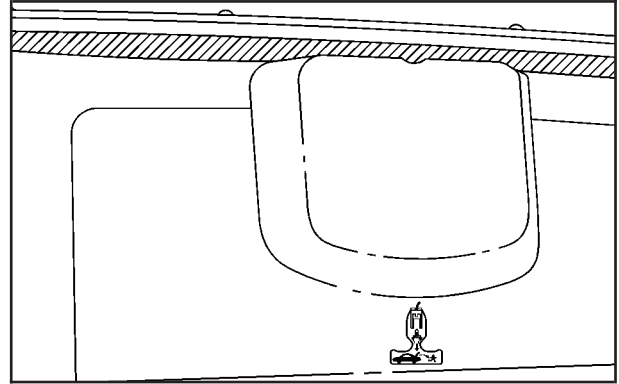

Notice: Using the emergency trunk release handle as a tie-down or anchor point when securing items in the trunk may damage it. Use the emergency trunk release handle only to help you open the trunk lid.

There is a glow-in-the-dark emergency trunk release handle located on the rear wall of the trunk below the latch. This handle will glow following exposure to light. Pull the release handle down to open the trunk from the inside.

Windows

CAUTION:

Leaving children, helpless adults, or pets in a vehicle with the windows closed is dangerous. They can be overcome by the extreme heat and suffer permanent injuries or even death from heat stroke. Never leave a child, a helpless adult, or a pet alone in a vehicle, especially with the windows closed in warm or hot weather.



Power Windows

With power windows, switches on the door control each window when the ignition is on or when RAP is present. See “Retained Accessory Power (RAP)” under *Ignition Positions* on page 2-20.

Express-Down Window



Both driver's and passenger's window switches have the express-down feature. Tap AUTO and immediately release. The window will lower completely. To stop the express-down feature from lowering the window completely, simply tap the switch again.

You can also open the window any amount by pressing and releasing the switch.

To close the window, press and hold the up arrow.

Sun Visors

To block out glare, you can swing down the visors. You can also swing them to the side.

Lighted Visor Vanity Mirrors

Pull down the sun visor and lift the cover to expose the lighted vanity mirror. When the cover is lifted, the lamps will come on automatically, even if the ignition is off.

Theft-Deterrent Systems

Vehicle theft is big business, especially in some cities. Although your vehicle has a number of theft-deterrent features, we know that nothing we put on it can make it impossible to steal. However, there are ways you can help.

Theft-Deterrent System

Your vehicle is equipped with a theft-deterrent alarm system.



SECURITY

With this system, the SECURITY light will flash as you open the door if your ignition is off. This light reminds you to arm the theft-deterrent system.

Arming the System

Use one of the two following items listed here to arm the system:

- Press the lock button on the remote keyless entry transmitter.
- Open the door. The SECURITY light should flash. Lock the door with the power door lock switch. The SECURITY light will stop flashing and stay on. Close the door. The security light should go off.

Now, if a door or the hatch/trunk lid is opened without the key or the remote keyless entry transmitter, the alarm will go off. Your horn will sound for two minutes, then it will go off to save battery power. And, your vehicle will not start.

The theft-deterrent system will not arm if you lock the driver's door with a key, the manual door lock, or if you use the power door lock after the doors are closed.

If your passenger stays in the vehicle when you leave with the keys, have the passenger lock the vehicle after the doors are closed. This way the alarm will not arm, and your passenger will not set it off.

Testing the Alarm

To test the system, do the following:

1. Make sure the hatch/trunk lid is latched.
2. Lower the window on the driver's door.
3. Manually arm the system.
4. Close the doors and wait 15 seconds.
5. Reach through the open window and manually unlock the driver's door.
6. Open the door. The alarm should sound.
7. Turn off the alarm.

If the alarm is inoperative, check to see if the horn works. If not, check the horn fuse. See *Fuses and Circuit Breakers* on page 5-93. If the horn works, but the alarm does not go off, see your dealer.

Disarming the System

Always use your key or the remote keyless entry transmitter to unlock a door. Unlocking a door any other way will set off the alarm. If your alarm sounds, listed below are the ways you can disarm it.

- Unlock the driver's door with your key.
- Put the key in the ignition.
- Press the unlock button on the remote keyless entry transmitter.

PASS-Key®

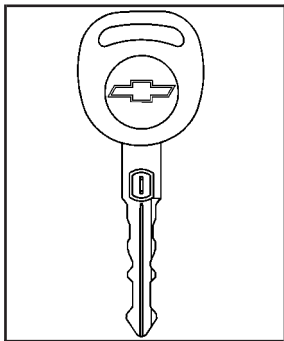

Your vehicle is equipped with the PASS-Key® (Personalized Automotive Security System) theft-deterrent system. PASS-Key® is a passive theft-deterrent system. It works when you insert or remove the key from the ignition.

PASS-Key® uses a resistor pellet in the ignition key that matches a decoder in your vehicle.

When the PASS-Key® system senses that someone is using the wrong key, it shuts down the vehicle's starter and fuel systems. For about three minutes, the starter will not work and fuel will not go to the engine. If someone tries to start your vehicle again or uses another key during this time, the shutdown period will start over again. This discourages someone from randomly trying different keys with different resistor pellets in an attempt to make a match.

The key must be clean and dry before it is inserted in the ignition or the engine may not start. If the SECURITY light comes on, the key may be dirty or wet.

If this happens and the starter will not work, turn the ignition off. Clean and dry the key, wait three minutes and try again. If the starter still will not work, wait three minutes and try the other ignition key. At this time, you may also want to check the fuses. See *Fuses and Circuit Breakers on page 5-93*. If the starter will not work with the other key, your vehicle needs service. If your vehicle does start, the first ignition key may be faulty. See your dealer or a locksmith who can service the PASS-Key®.

If you accidentally use a key that has a damaged or missing resistor pellet, you will see no SECURITY light. You do not have to wait three minutes before trying the proper key.

If the resistor pellet is damaged or missing, the starter will not work. Use the other ignition key, and see your dealer or a locksmith who can service the PASS-Key® to have a new key made.

If the SECURITY light comes on while driving, have your vehicle serviced as soon as possible.

If you lose or damage a PASS-Key® ignition key, see your dealer or a locksmith who can service PASS-Key®. In an emergency, call Chevrolet Roadside Assistance. See *Roadside Assistance Program on page 7-6* for more information.

Starting and Operating Your Vehicle

New Vehicle Break-In

Notice: Your vehicle does not need an elaborate “break-in.” But it will perform better in the long run if you follow these guidelines:

- **Keep your speed at 55 mph (88 km/h) or less for the first 500 miles (805 km).**
- **Do not drive at any one speed — fast or slow — for the first 500 miles (805 km). Do not make full-throttle starts.**
- **Avoid making hard stops for the first 200 miles (322 km) or so. During this time your new brake linings are not yet broken in. Hard stops with new linings can mean premature wear and earlier replacement. Follow this breaking-in guideline every time you get new brake linings.**

Front Air Dam

Your vehicle is equipped with a front air dam which has minimal ground clearance for aerodynamics. For this reason, the air dam has a spring-loaded hinge provided and it will retract with road contact.

Under normal operation, the air dam will occasionally contact some road surfaces (speed bumps, driveway ramps, etc.). This can be heard inside the vehicle as a scraping noise. This is normal and does not indicate a problem.

Use care when approaching bumps or objects on road surfaces and avoid them when possible.

Ignition Positions

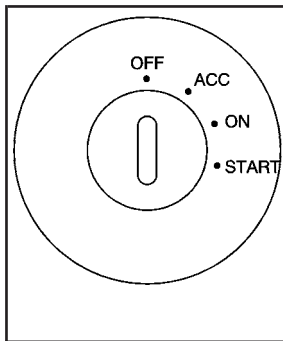

With the key in the ignition switch, you can turn it to four different positions.

OFF: This is the only position from which you can remove the key.

If you have an automatic transmission, the ignition switch cannot be turned to OFF unless the shift lever is in PARK (P).

ACC (ACCESSORY): This is the position in which you can operate your electrical accessories.

CAUTION:

If you have a manual transmission removing the key from the ignition switch will lock the steering column and result in a loss of ability to steer the vehicle. This could cause a collision. If you need to turn the engine off while the vehicle is moving, turn the key to ACC.

Notice: If your key seems stuck in OFF and you can not turn it, be sure you are using the correct key; if so, is it all the way in? Turn the key only with your hand. Using a tool to force it could break the key or the ignition switch. If none of this works, then your vehicle needs service.

ON: This is the position to which the switch returns after you start the engine and release the key. The switch stays in ON while the engine is running. But even when the engine is not running, you can use ON to operate your electrical accessories and to display some instrument panel cluster messages and telltales.

START: This position starts the engine. When the engine starts, release the key. The ignition switch will return to ON for normal driving.

When the engine is not running, ACCESSORY and ON allow you to operate your electrical accessories, such as the radio.

A warning tone will sound if you open the driver's door while the ignition is in OFF or ACCESSORY and the key is in the ignition.

Retained Accessory Power (RAP)

With RAP, your power windows and the audio system will continue to work for up to 15 minutes after the ignition key is turned to OFF and neither door is opened. If a door is opened, the power windows and audio system will shut off.

Starting Your Engine

This vehicle has a computer system that monitors engine speed, throttle and pedal position, and records the current status.

Automatic Transmission

Move your shift lever to PARK (P) or NEUTRAL (N). Your engine will not start in any other position – that is a safety feature. To restart when you are already moving, use NEUTRAL (N) only.

Notice: Do not try to shift to PARK (P) if your vehicle is moving. If you do, you could damage the transmission. Shift to PARK (P) only when your vehicle is stopped.

Manual Transmission

The shift lever should be in NEUTRAL and the parking brake engaged. Hold the clutch pedal to the floor and start the engine. Your vehicle will not start if the clutch pedal is not all the way down – that is a safety feature.

1. With your foot off the accelerator pedal, turn the ignition key to START. When the engine starts, let go of the key. The idle speed will go down as your engine gets warm.

Notice: Holding your key in START for longer than 15 seconds at a time will cause your battery to be drained much sooner. And the excessive heat can damage your starter motor. Wait about 15 seconds between each try to help avoid draining your battery or damaging your starter.

2. If it does not start within 10 seconds, push the accelerator pedal all the way to the floor, while you hold the ignition key in START. When the engine starts, let go of the key and let up on the accelerator pedal. Wait about 15 seconds between each try.

When starting your engine in very cold weather (below 0°F or -18°C), do this:

1. With your foot off the accelerator pedal, turn the ignition key to START and hold it there up to 15 seconds. When the engine starts, let go of the key.
2. If your engine still will not start (or starts but then stops), it could be flooded with too much gasoline. Try pushing your accelerator pedal all the way to the floor and holding it there as you hold the key in START for about three seconds. When the engine starts, let go of the key and accelerator. If the vehicle starts briefly but then stops again, do the same thing, but this time keep the pedal down for five or six seconds. This clears the extra gasoline from the engine.

Notice: Your engine is designed to work with the electronics in your vehicle. If you add electrical parts or accessories, you could change the way the engine operates. Before adding electrical equipment, check with your dealer. If you do not, your engine might not perform properly.

Starter Interlock Feature

For your convenience and to avoid damage to your starter, your vehicle is equipped with a starter interlock feature. This feature will not allow you to crank the engine while the vehicle is already running.

Racing or Other Competitive Driving

See your warranty book before using your vehicle for racing or other competitive driving.

Notice: If you use your vehicle for racing or other competitive driving, the engine may use more oil than it would with normal use. Low oil levels can damage the engine. Be sure to check the oil level often during racing or other competitive driving and keep the level at or near 1 quart (1 L) above the upper mark that shows the proper operating range on the engine oil dipstick. For information on how to add oil, see *Engine Oil on page 5-13*. After the competitive driving, remove excess oil so that the level on the dipstick is not above the upper mark that shows the proper operating range.

Engine Coolant Heater

The engine coolant heater is located on the driver's side of the engine under the manifold.

In very cold weather, 0°F (-18°C) or colder, the engine coolant heater can help. You will get easier starting and better fuel economy during engine warm-up. Usually, the coolant heater should be plugged in a minimum of four hours prior to starting your vehicle. At temperatures above 32°F (0°C), use of the coolant heater is not required.

To Use The Engine Coolant Heater

1. Turn off the engine.
2. Open the hood and unwrap the electrical cord.
The electrical cord is attached to the generator bracket assembly, between the generator and the windshield washer fluid tank. With the headlamps closed, route the cord in the opening between the headlamp door and the fender panel on the driver's side of the vehicle. Do not pinch the cord when closing the hood.
3. Plug it into a normal, grounded 110-volt AC outlet.

4. Before starting the engine, be sure to unplug and store the cord as it was before to keep it away from moving engine parts. If you do not it could be damaged.

How long should you keep the coolant heater plugged in? The answer depends on the outside temperature, the kind of oil you have, and some other things. Instead of trying to list everything here, we ask that you contact your dealer in the area where you will be parking your vehicle. The dealer can give you the best advice for that particular area.

CAUTION:

Plugging the cord into an ungrounded outlet could cause an electrical shock. Also, the wrong kind of extension cord could overheat and cause a fire. You could be seriously injured. Plug the cord into a properly grounded three-prong 110-volt AC outlet. If the cord will not reach, use a heavy-duty three-prong extension cord rated for at least 15 amps.

Automatic Transmission Operation



There are several different positions for your shift lever.

PARK (P): This position locks your rear wheels. It is the best position to use when you start your engine because your vehicle cannot move easily.

CAUTION:

It is dangerous to get out of your vehicle if the shift lever is not fully in PARK (P) with the parking brake firmly set. Your vehicle can roll.

Do not leave your vehicle when the engine is running unless you have to. If you have left the engine running, the vehicle can move suddenly. You or others could be injured. To be sure your vehicle will not move, even when you are on fairly level ground, always set your parking brake and move the shift lever to PARK (P). See *Shifting Into Park (P)* on page 2-32.

Be sure the shift lever is fully in PARK (P) before starting the engine. Your vehicle has an automatic transmission shift lock control system.

You have to fully apply your regular brakes before you can shift from PARK (P) when the ignition key is in ON. If you cannot shift out of PARK (P), ease pressure on the shift lever – push the shift lever all the way into PARK (P) and release the shift lever button as you maintain brake application. Then press the shift lever button and move the shift lever into the gear you wish. If you do not apply the brake after 15 seconds once the ignition is turned on, you will receive a PRESS BRAKE BEFORE SHIFT message in the Driver Information Center (DIC). See *Shifting Out of Park (P)* on page 2-34.

REVERSE (R): Use this gear to back up.

Notice: Shifting to REVERSE (R) while your vehicle is moving forward could damage the transmission. The repairs would not be covered by your warranty. Shift to REVERSE (R) only after your vehicle is stopped.

To rock your vehicle back and forth to get out of snow, ice or sand without damaging your transmission, see *If You Are Stuck: In Sand, Mud, Ice or Snow* on page 4-32.

NEUTRAL (N): In this position, your engine does not connect with the wheels. To restart when you are already moving, use NEUTRAL (N) only. Also, use NEUTRAL (N) when your vehicle is being towed.

 **CAUTION:**

Shifting into a drive gear while your engine is running at high speed is dangerous. Unless your foot is firmly on the brake pedal, your vehicle could move very rapidly. You could lose control and hit people or objects. Do not shift into a drive gear while your engine is running at high speed.

Notice: Shifting out of PARK (P) or NEUTRAL (N) with the engine racing may damage the transmission. The repairs would not be covered by your warranty. Be sure the engine is not racing when shifting your vehicle.

AUTOMATIC OVERDRIVE (Ⓚ): This position is for normal driving.

THIRD (3): This position is also used for normal driving. However, it offers more power and lower fuel economy than AUTOMATIC OVERDRIVE (ⓓ).

Here are some times you might choose THIRD (3) instead of AUTOMATIC OVERDRIVE (ⓓ):

- When driving on hilly, winding roads.
- When going down a steep hill.

SECOND (2): This position gives you more power but lower fuel economy than THIRD (3). You can use SECOND (2) on hills. It can help control your speed as you go down steep mountain roads, but then you would also want to use your brakes off and on.

If you manually select SECOND (2) when you start the vehicle, the transmission will drive (and stay) in second gear. You may use this feature for reducing torque to the rear wheels when you are trying to start your vehicle from a stop on slippery road surfaces, or for preventing the transmission from downshifting into FIRST (1) in situations where a downshift would be undesirable.

FIRST (1): This position gives you even more power, but lower fuel economy, than SECOND (2). You can use it on very steep hills, in deep snow or mud. If the shift lever is put in FIRST (1), the transmission will not shift into first gear until the vehicle is going slowly enough.

Notice: Spinning the tires or holding the vehicle in one place on a hill using only the accelerator pedal may damage the transmission. If you are stuck, do not spin the tires. When stopping on a hill, use the brakes to hold the vehicle in place.

Maximum engine speed is limited to protect driveline components from improper operation.

Manual Transmission Operation

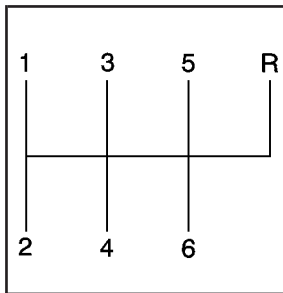

This is the shift pattern for the six-speed manual transmission.

Here is how to operate your transmission:

FIRST (1): Press the clutch pedal and shift into FIRST (1). Then slowly let up on the clutch pedal as you press the accelerator pedal.

You can shift into FIRST (1) when you are going less than 40 mph (64 km/h). If you come to a complete stop and it is hard to shift into FIRST (1), put the shift lever in NEUTRAL and let up on the clutch. Press the clutch pedal back down. Then shift into FIRST (1).

SECOND (2): Press the clutch pedal as you let up on the accelerator pedal and shift into SECOND (2). Then, slowly let up on the clutch pedal as you press the accelerator pedal.

THIRD (3), FOURTH (4), FIFTH (5) and SIXTH (6): Shift into THIRD (3), FOURTH (4), FIFTH (5) and SIXTH (6) the same way you do for SECOND (2). Slowly let up on the clutch pedal as you press the accelerator pedal.

To stop, let up on the accelerator pedal and press the brake pedal. Just before the vehicle stops, press the clutch pedal and the brake pedal, and shift to NEUTRAL.

NEUTRAL: Use this position when you start or idle your engine. Your shift lever is in NEUTRAL when it is centered in the shift pattern, not in any gear.

REVERSE (R): To back up, press down the clutch pedal and shift into REVERSE (R). Just apply pressure to get the lever past FIFTH (5) and SIXTH (6) into REVERSE (R). Let up on the clutch pedal slowly while pressing the accelerator pedal.

Your six-speed manual transmission has a feature that allows you to safely shift into REVERSE (R) while the vehicle is rolling (at less than 3 mph (5 km/h)). You will be locked out if you try to shift into REVERSE (R) while your vehicle is moving faster than 3 mph (5 km/h). If you have turned your ignition off and wish to park your vehicle in REVERSE (R), you will have to move the shift lever quickly to the right, and immediately forward into gear.

Shift Speeds (Manual Transmission)

CAUTION:

If you skip a gear when you downshift, you could lose control of your vehicle. You could injure yourself or others. Don't shift down more than one gear at a time when you downshift.

This chart shows when to shift to the next higher gear for the best fuel economy.

Manual Transmission Recommended Shift Speeds in mph (km/h)					
Engine	Acceleration Shift Speed				
	1 to 2	2 to 3	3 to 4	4 to 5	5 to 6
All Engines	15 (24)	25 (40)	40 (64)	45 (72)	50 (80)

If your engine speed drops below 900 rpm, or if the engine is not running smoothly, you should downshift to the next lower gear. You may have to downshift two or more gears to keep the engine running smoothly or for good engine performance.

Notice: When shifting gears, do not move the shift lever around unnecessarily. This may damage the transmission. Shift directly into the next gear.

One to Four Shift Light (Manual Transmission)



When this light comes on, you can only shift from FIRST (1) to FOURTH (4) instead of FIRST (1) to SECOND (2).

You must complete the shift into FOURTH (4) to turn off this feature. This helps you get the best possible fuel economy.

After shifting to FOURTH (4), you may downshift to a lower gear if you prefer.

Notice: Forcing the shift lever into any gear except FOURTH (4) when the 1 TO 4 SHIFT light comes on may damage the transmission. Shift only from FIRST (1) to FOURTH (4) when the light comes on.

This light will come on when:

- The engine coolant temperature is higher than 169°F (76°C),
- you are going 15 to 19 mph (24 to 31 km/h) and
- you are 21 percent throttle or less.

Downshifting (Manual Transmission)

If your vehicle is a coupe or convertible, do not downshift into the gear shown below at a speed greater than shown in the table:

FIRST (1)	50 mph (80 km/h)
SECOND (2)	74 mph (119 km/h)
THIRD (3)	101 mph (163 km/h)
FOURTH (4)	130 mph (209 km/h)

If your vehicle is a Z06, do not downshift into a gear shown below at a speed greater than shown in the table:

FIRST (1)	48 mph (77 km/h)
SECOND (2)	69 mph (111 km/h)
THIRD (3)	100 mph (161 km/h)
FOURTH (4)	143 mph (230 km/h)

Notice: If you skip more than one gear when you downshift, or if you race the engine when you release the clutch pedal while downshifting, you could damage the engine, clutch, driveshaft or the transmission. Do not skip gears or race the engine when downshifting.

The six-speed transmission has a spring that centers the shift lever near THIRD (3) and FOURTH (4). This spring helps you know which gear you are in when you are shifting. Be careful when shifting from FIRST (1) to SECOND (2) or downshifting from SIXTH (6) to FIFTH (5). The spring will try to pull the shift lever toward FOURTH (4) and THIRD (3). Make sure you move the lever into SECOND (2) or FIFTH (5). If you let the shift lever move in the direction of the pulling, you may end up shifting from FIRST (1) to FOURTH (4) or from SIXTH (6) to THIRD (3).

Parking Brake



To set the parking brake, hold the brake pedal down. Pull the parking brake lever up. If the ignition is on, the brake system warning light will come on.

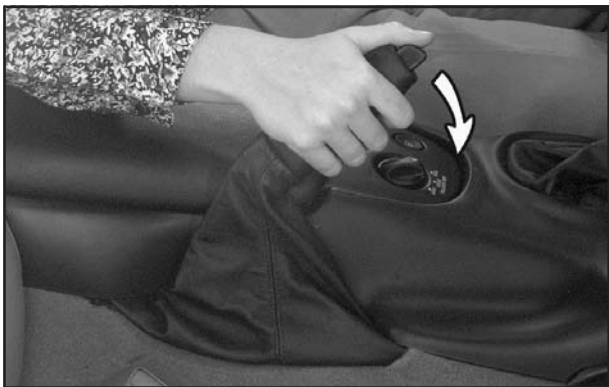

To release the parking brake, hold the brake pedal down. Then push the release button in as you move the parking brake lever all the way down.

Notice: Driving with the parking brake on can overheat the brake system and cause premature wear or damage to brake system parts. Verify that the parking brake is fully released and the brake warning light is off before driving.

Shifting Into Park (P)

CAUTION:

It can be dangerous to get out of your vehicle if the shift lever is not fully in PARK (P) with the parking brake firmly set. Your vehicle can roll. If you have left the engine running, the vehicle can move suddenly. You or others could be injured. To be sure your vehicle will not move, even when you are on fairly level ground, use the steps that follow.

1. Hold the brake pedal down with your right foot and set the parking brake.



2. Move the shift lever into PARK (P) by holding in the button on the lever and pushing the lever all the way toward the front of the vehicle.
3. Turn the ignition key to OFF.
4. Remove the key and take it with you. If you can remove the key from the ignition, the vehicle is in PARK (P).

Leaving Your Vehicle With the Engine Running (Automatic Transmission)

CAUTION:

It can be dangerous to leave your vehicle with the engine running. Your vehicle could move suddenly if the shift lever is not fully in PARK (P) with the parking brake firmly set. And, if you leave the vehicle with the engine running, it could overheat and even catch fire. You or others could be injured. Do not leave your vehicle with the engine running.

If you have to leave your vehicle with the engine running, be sure your vehicle is in PARK (P) and your parking brake is firmly set before you leave it. After you have moved the shift lever into PARK (P), hold down the regular brake pedal. See if you can move the shift lever away from PARK (P) without first pulling it toward you. If you can, it means that the shift lever was not fully locked into PARK (P).

Torque Lock (Automatic Transmission)

If you are parking on a hill and you do not shift your transmission into PARK (P) properly, the weight of the vehicle may put too much force on the parking pawl in the transmission. You may find it difficult to pull the shift lever out of PARK (P). This is called “torque lock.” To prevent torque lock, set the parking brake and then shift into PARK (P) properly before you leave the driver’s seat. To find out how, see “Shifting Into PARK (P)” listed previously in this section.

When you are ready to drive, move the shift lever out of PARK (P) *before* you release the parking brake.

If torque lock does occur, you may need to have another vehicle push yours a little uphill to take some of the pressure from the transmission parking pawl, so you can pull the shift lever out of PARK (P).

Shifting Out of Park (P)

Your vehicle has an automatic transmission shift lock control system which locks the shift lever in PARK (P) when the ignition is in the off position. In addition, you have to fully apply your regular brake before you can shift from PARK (P) when the ignition is in ON. See *Automatic Transmission Operation on page 2-25*.

As a reminder, you will see a message in the Driver Information Center (DIC) that will say PRESS BRAKE BEFORE SHIFT within 15 seconds unless the brake is pressed.

If you cannot shift out of PARK (P), ease pressure on the shift lever and push the shift lever all the way into PARK (P) and release the shift lever button as you maintain brake application. Then press the shift lever button and move the shift lever into the gear you wish.

If you ever hold the brake pedal down but still can't shift out of PARK (P), try this:

1. Turn the key to ACCESSORY.
2. Apply and hold the brake until the end of Step 4.
3. Shift to NEUTRAL (N).
4. Start the engine and then shift to the drive gear you want.
5. Have the system fixed as soon as possible.

Parking Your Vehicle (Manual Transmission)

Before you get out of your vehicle, move the shift lever into REVERSE (R) and firmly apply the parking brake. Once the shift lever has been placed into REVERSE (R) with the clutch pedal pressed in, you can turn the ignition key to OFF, remove the key and release the clutch.

Parking Over Things That Burn

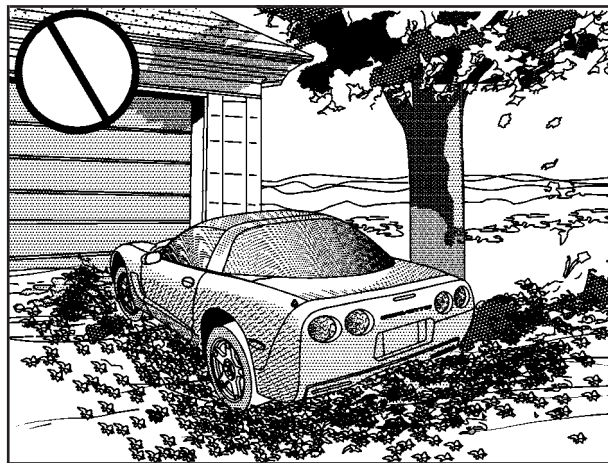

CAUTION:

Things that can burn could touch hot exhaust parts under your vehicle and ignite. Do not park over papers, leaves, dry grass or other things that can burn.

Engine Exhaust

CAUTION:

Engine exhaust can kill. It contains the gas carbon monoxide (CO), which you can not see or smell. It can cause unconsciousness and death.

You might have exhaust coming in if:

- Your exhaust system sounds strange or different.
- Your vehicle gets rusty underneath.
- Your vehicle was damaged in a collision.
- Your vehicle was damaged when driving over high points on the road or over road debris.
- Repairs were not done correctly.
- Your vehicle or exhaust system had been modified improperly.

If you ever suspect exhaust is coming into your vehicle:

- Drive it only with all the windows down to blow out any CO; and
- Have your vehicle fixed immediately.

Running Your Engine While You Are Parked (Automatic Transmission)

It's better not to park with the engine running. But if you ever have to, here are some things to know.

CAUTION:

Idling the engine with the climate control system off could allow dangerous exhaust into your vehicle. See the earlier Caution under *Engine Exhaust on page 2-36*.

Also, idling in a closed-in place can let deadly carbon monoxide (CO) into your vehicle even if the climate control fan is at the highest setting. One place this can happen is a garage. Exhaust — with CO — can come in easily. NEVER park in a garage with the engine running.

Another closed-in place can be a blizzard. See *Winter Driving on page 4-28*.

 **CAUTION:**

It can be dangerous to get out of your vehicle if the shift lever is not fully in PARK (P) with the parking brake firmly set. Your vehicle can roll. Do not leave your vehicle when the engine is running unless you have to. If you have left the engine running, the vehicle can move suddenly. You or others could be injured. To be sure your vehicle will not move, even when you are on fairly level ground, always set your parking brake and move the shift lever to PARK (P).

Follow the proper steps to be sure your vehicle won't move. See *Shifting Into Park (P)* on page 2-32.

Mirrors

Manual Rearview Mirror

An inside rearview mirror is attached above the windshield. The mirror pivots so that you can adjust it.

You can adjust the mirror for day or night driving. Pull the tab for night driving to reduce glare. Push the tab forward for daytime driving.

Automatic Dimming Rearview Mirror

Your vehicle may have an automatic dimming rearview mirror with map lamps.

This mirror automatically changes to reduce glare from headlamps behind you. A time delay feature prevents rapid changing from the day to night positions while driving under lights and through traffic.



The mirror includes two map lamps and an automatic dimming function. There is also an interior console flood lamp located underneath the rearview mirror which remains on at all times.

IO (On/Off): The automatic dimming feature is turned on or off by pressing this button located on the lower part of the mirror. Press and hold the button for up to three seconds to turn this feature on or off.

When cleaning the mirror, use a paper towel or similar material dampened with glass cleaner. Do not spray glass cleaner directly on the mirror housing.

Outside Power Heated Mirrors



The power mirror control is on the driver's door. It controls the driver's and passenger's mirrors.

To adjust either mirror, press the LT (left) or RT (right) button to select the mirror, then press the arrows to adjust the direction of the mirror. The mirror will stay selected for 20 seconds after the last adjustment. An indicator light will come on above the mirror that you select.

Your preferred mirror position can be stored if you have the memory option. See *Memory on page 2-57*.

For operation of the heated outside mirrors, see *Dual Automatic Climate Control System on page 3-23*.

Outside Automatic Dimming Mirror

If your vehicle has this feature, the driver's side outside mirror will adjust for the glare of headlamps behind you. This feature is controlled by the on and off setting on the inside mirror. See *Automatic Dimming Rearview Mirror on page 2-38*.

Outside Convex Mirror

Your passenger's side mirror is convex. A convex mirror's surface is curved so you can see more from the driver's seat.

CAUTION:

A convex mirror can make things (like other vehicles) look farther away than they really are. If you cut too sharply into the right lane, you could hit a vehicle on your right. Check your inside mirror or glance over your shoulder before changing lanes.

Storage Areas

Glove Box

To open the glove box, lift up on the lever. Use your door key to lock or unlock it. The glove box has a light inside.

Cupholder(s)

The cupholder is located on the center console in front of the ashtray. To open it, place your thumb on the left side of the lid and push down. Raise the right side with your index finger.

Center Console Storage Area



To use this storage area, pull up the lid on the driver's side front edge of the console and swing it to the passenger's side.

You can use the key to lock and unlock the console. Do not leave the key in the lock, or it could be damaged when the driver sits down.

The fuel filler door release button and accessory power outlet are located inside the center console.

Floor Mats

The floor mats are specially designed to remain in position under your feet and out of reach of the accelerator pedal. The driver's side floor mat is held in place by two locator hooks and the passenger's side is held in place by one.

Be sure that the driver's side floor mat is properly placed on the floor so that it does not block the movement of the accelerator pedal.

How to Remove and Replace the Floor Mats

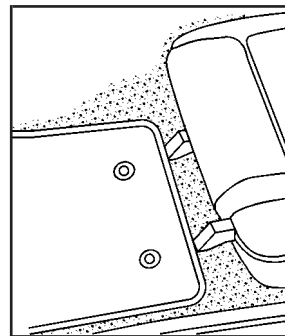

To remove the floor mats, pull up on the rear of the mat to disconnect from the locator hooks.

To reinstall the floor mats, line up the openings in the floor mat over the locator hooks and push down into place.

Rear Storage Area

There are three rear storage compartments in the floor of the rear hatch/trunk area.

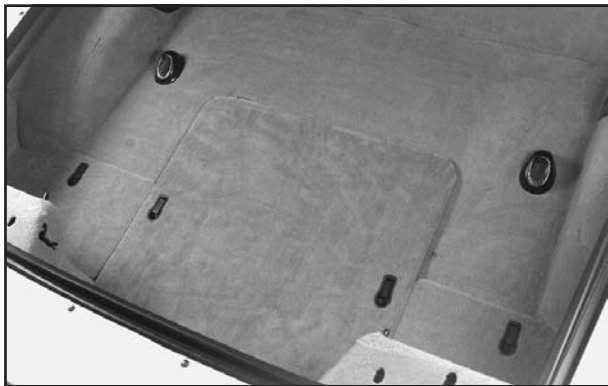

Coupe shown, Convertible and Z06 similar

If you have a coupe or convertible model, your vehicle will be equipped with three storage compartment lids. If you have a Z06, your vehicle's three storage compartments will not have lids.



To access a storage compartment, pull up on the latch to release the lid. Remove the storage compartment lid.

When replacing a storage compartment lid, make sure the latch is in the correct location so the latch locks securely into place.

Notice: Placing heavy objects, which may shift or slide while driving, in the center storage area could damage your CD changer. If your vehicle has the optional CD changer, do not put heavy objects in the center storage area.

Notice: Do not store heavy or sharp objects in the rear storage compartments located in the hatch/trunk area. If you do, the objects could damage the underbody.

Convenience Net

If your vehicle has this feature you will see it on the back wall of the rear area of the vehicle.

Put small loads, like grocery bags, in the net. It can help keep them from falling over during sharp turns or quick starts and stops. The convenience net is not for larger, heavier loads.

You can unhook the net and place it in one of the rear storage compartments when you are not using it. On coupe models only, a plastic storage bag has also been provided.

Cargo Cover

If your vehicle has this feature, the security shade can provide hidden storage in the rear area of the vehicle. The shade is also helpful in blocking the glare from the removable roof when it is stored in the rear compartment.

Using the Cargo Cover

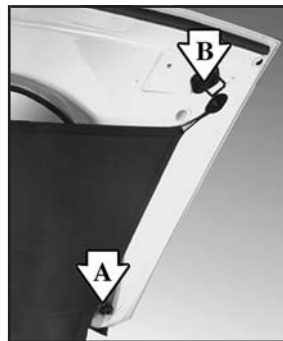

1. Hook the elastic loops on the front corners (A) of the shade to the T-nuts located on the front corners of the rear hatch frame.

2. Hook the elastic loops on the rear corners (B) of the shade to the hooks recessed inside the rear hatch frame, near the rear corners.

Roof Panel

Your vehicle may have a removable roof panel.

Removing the Roof Panel

CAUTION:

Do not try to remove a roof panel while the vehicle is moving. Trying to remove the roof panel while the vehicle is moving could cause an accident. The panel could fall into the vehicle and cause you to lose control, or it could fly off and strike another vehicle. You or others could be injured. Remove the roof panel only when the vehicle is parked.

Until you are sure you can remove the panel alone, have someone help you.

Notice: If you drop or rest a roof panel on its edges, the roof panel, paint and/or weatherstripping may be damaged. Always place the roof panel in the stowage receivers after removing it from the vehicle.

1. Park on a level surface, set the parking brake firmly and shift an automatic transmission into PARK (P). Shift a manual transmission into REVERSE (R).
2. Turn the ignition key to OFF. Lower both sun visors and turn them toward the door glass.
3. Open the rear hatch and remove any items that may interfere with proper storage of the roof panel.



4. Make sure to install the two egg-shaped storage receivers into the floor of the rear storage compartment. Secure both receivers into their proper positions by turning them counterclockwise.
5. Lower the windows and open the doors.

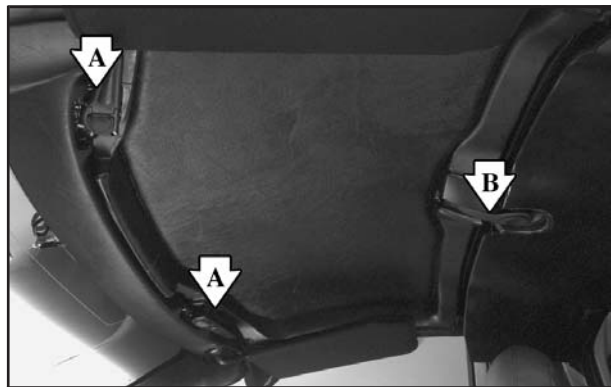

There are two latches on the front of the roof panel near each door (A), and one rear latch (B).

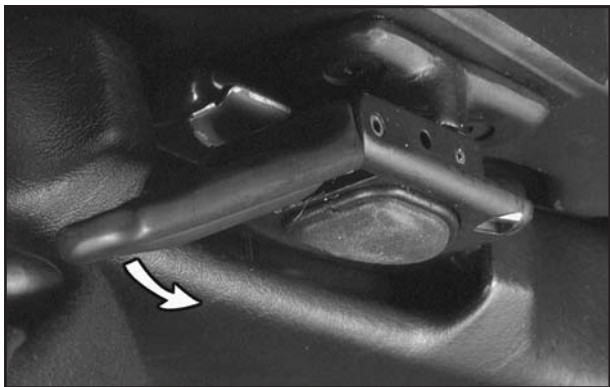

6. To unlock the front of the roof panel, pull down each of the front handles. Grasp the handles with your fingers and pull each toward you. Complete a 180° turn toward the center of the vehicle. Then push up on each of the handles.



7. To unlock the rear of the roof panel, press the latch release button with your thumb and pull down the latch lever with your fingers.
8. After releasing the latches, return the sun visors to the forward position.



9. Stand on one side of the vehicle and, if necessary, have your helper stand on the other side. Together, carefully lift the front edge of the panel up and forward, and out of the vehicle opening.
10. When the panel is loosened from the vehicle, one person should grasp the roof panel as close to the center of the vehicle as possible and lift away the panel.

Storing the Roof Panel

CAUTION:

If a roof panel is not stored properly, it could be thrown about the vehicle in a crash or sudden maneuver. People in the vehicle could be injured. Whenever you store a roof panel in the vehicle, always be sure that it is stored securely in the proper location.

Notice: If you drop or rest a roof panel on its edges, the roof panel, paint and/or weatherstripping may be damaged. Always place the roof panel in the stowage receivers after removing it from the vehicle.

1. Turn the roof panel so that the rear edge of the panel is facing the storage area. The locating pins (at the rear of the panel) should point toward the egg-shaped stowage receivers on the floor of the center compartment.
2. Push the panel forward until the pins bottom out in the receivers.

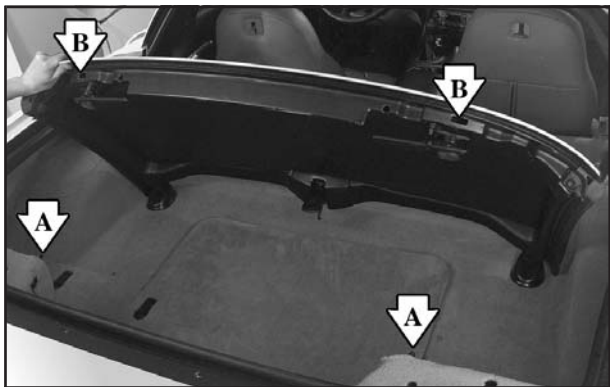

3. There are two spring-loaded storage pins on the rear wall of the storage compartment (A). These storage pins go into the slots on each side of the roof panel (B).

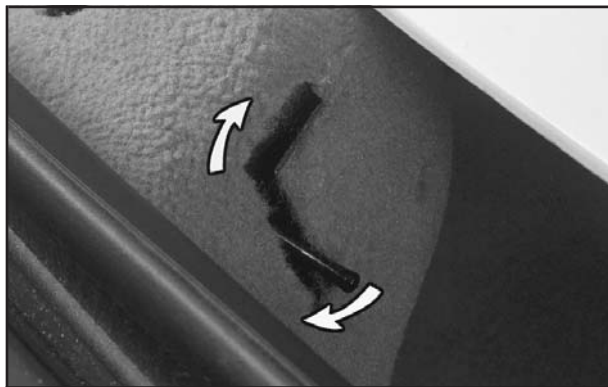

4. Gently lower the roof panel onto the carpeted ledge. Then, pull each release rearward and upward to place the storage pins into the holes of the roof panel.
5. Gently lift and lower the roof panel to be sure it is locked into place.

Installing the Roof Panel

CAUTION:

An improperly attached roof panel may fall into or fly off the vehicle. You or others could be injured. After installing the roof panel, always check that it is firmly attached by pushing up on the underside of the panel. Check now and then to be sure the roof panel is firmly in place.

Notice: If you drop or rest a roof panel on its edges, the roof panel, paint and/or weatherstripping may be damaged. Always place the roof panel in the stowage receivers after removing it from the vehicle.

In most cases, it is easier to install the removable roof with two people rather than one.

1. Check to be sure that the front handles and rear latch on the ceiling are in their opened positions before attempting to install the roof panel.
2. If the roof panel is stored in the rear area, grasp it with your right hand at the middle edge near the seatbacks, and with your left hand at the middle of the edge closest to you. Reverse the steps described previously under *Storing the Roof Panel on page 2-47*.
3. Remove the roof panel from the storage compartment.
4. Place the roof panel over the vehicle.



5. Position the rear edge of the roof panel to the weatherstrip on the back of the roof opening (A). Then align the pins at the rear of the roof panel weatherstrip with the receiving cup in the body weatherstrip (B). Gently lower the front edge of the roof panel to the front of the body opening (C).

6. Turn the front handles toward the side doors to the closed position.
7. Hook the rear latch by pushing the lever up to the locked position.
8. Grasp and tug the roof panel up and down and side-to-side to make sure the roof panel is securely installed.

Convertible Top

If your vehicle has this feature, the following procedures explain the proper operation of the convertible top.

Notice: Some automatic car washes may cause damage to your vehicle. To avoid possible damage, use touchless automatic car washes.

For care and cleaning of the convertible top, see "Cleaning Your Convertible Top" under *Cleaning the Outside of Your Vehicle* on page 5-85.

When lowering and raising the convertible top, you will use the following:

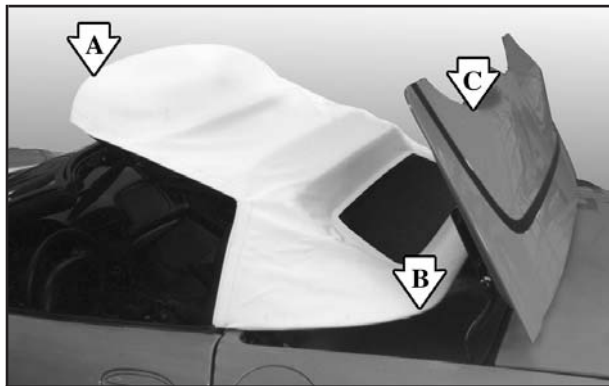

- A. Front Edge of the Convertible Top
- B. Rear Edge of the Convertible Top
- C. Storage Compartment Lid

Lowering the Convertible Top

Notice: Leaving the convertible top down and exposing the interior of your vehicle to outdoor conditions may cause damage. Always close the convertible top if leaving your vehicle outdoors.

1. Set the parking brake firmly. Shift an automatic transmission into PARK (P). Shift a manual transmission into REVERSE (R).
2. Turn the ignition key to OFF. Lower both sun visors and turn them toward the door glass.

Notice: Lowering the convertible top when there are objects in the storage area could damage it or break the glass rear window. Always verify that no objects are in the storage area before lowering the convertible top.

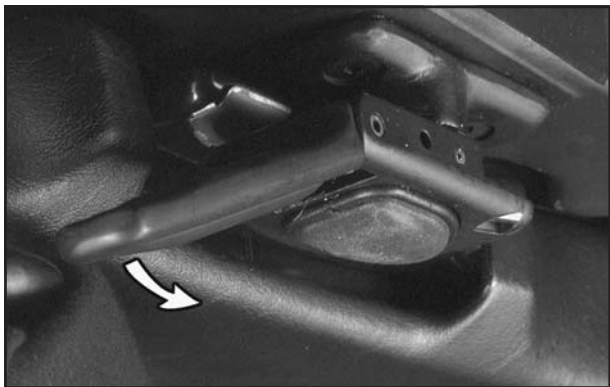

3. Unlock the front of the convertible top by lowering the latch handles and turning them inward. Push the latch handles back to the up position.



4. Lift upward on the front edge (A) of the convertible top off of the windshield frame. Then lift upward on the rear edge (B) of the convertible top to be vertical off the storage compartment lid (C). The front edge (A) and rear edge (B) should be straight up and down.



5. Tilt the driver's seatback forward and press the storage compartment release button located on the underside of the storage compartment lid (C) behind the driver's seat. Then raise the storage compartment lid (C). While attempting to raise the lid, if the lid does not release and you hear three chimes, check to make sure the trunk lid is closed. Also, the lid will not release if the alarm is turned on or the trunk lid is open.

After pressing the release button, the driver's and passenger's door glass should retract to the full-down position.

If the vehicle has lost battery power, you can still open the storage compartment lid (C) using the manual release cable.



The cable is located underneath the carpeting behind the driver's and passenger's seats, in the center of the vehicle. When using the manual release, you must first open the doors to prevent damage to the seals. To access the cable, lift and pull back the carpeting. Then pull the cable to release the storage compartment lid if needed.

Notice: If you lower the convertible top into the storage compartment and the rear edge of the top is not in the full-down position, you could damage the top. Always verify that the rear edge of the convertible top is in the full-down position before lowering the top into the storage compartment.



6. Push forward on the front edge (A) of the convertible top to allow the rear edge (B) of the convertible top to be moved to its full-down position.

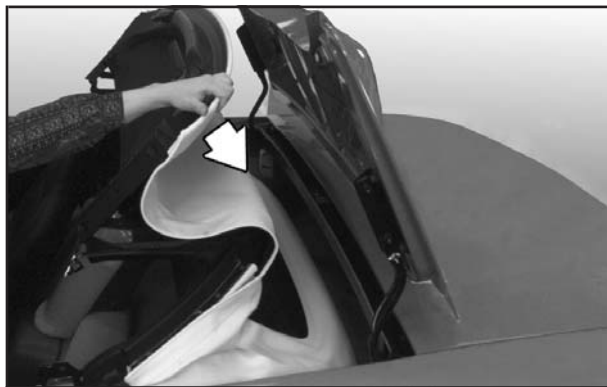

7. Then move the top rearward to its fully-stored position.
8. After the top is stored, apply one even push on the center of the front edge (A) of the convertible top to assure that the top is fully retracted.
9. Close the storage compartment lid (C) by closing with a swift, firm motion.

Raising the Convertible Top

1. Park on a level surface, set the parking brake firmly and shift an automatic transmission into PARK (P). Shift a manual transmission into REVERSE (R). Lower both windows and sun visors and turn the ignition key to OFF.



2. Tilt the driver's seat forward and press the storage compartment release button, or use the manual release cable if battery power has been lost. Lift the storage compartment lid (C).

After pressing the release button, the driver and passenger door glass should retract to the full-down position, if they have not already been lowered.



3. Pull the top up by firmly gripping the front edge (A) of the convertible top with your hand and applying a brisk, firm upward and forward motion to get the top in the full-up position.



4. Lift the rear edge (B) of the convertible top to its full-up position by first raising the front edge (A).
5. Close the storage compartment lid (C) by closing with a swift, firm motion.

6. Lower the rear edge (B) of the convertible top by first slightly pushing the front edge (A) of the convertible top forward.
7. Push the front edge (A) of the convertible top down from the outside of the vehicle, or pull the front edge (A) of the convertible top down from the center pull-down handle located in the inside of the vehicle.
8. Turn the latches outward to secure the top in the up position.

Vehicle Personalization

Memory



If your vehicle has this feature, MEMORY can store and recall the settings for the driver's seat position, the outside rearview mirror positions, telescopic steering column (if equipped), radio presets, tone, volume, playback mode (AM/FM, tape or CD), last displayed station, compact disc position and tape direction and the last climate control setting.

The MEMORY buttons are located on the driver's door, above the power mirror controls. The MEMORY buttons can store and recall settings for up to three drivers. Use button 1 to store the settings for the first driver, button 2 for a second driver or press buttons 1 and 2 at the same time for a third driver. To store your memory settings, do the following:

1. Adjust your settings for the driver's seat position, outside rearview mirror positions, and telescopic steering wheel (if equipped).
2. Press and hold a MEMORY button. The light above the MEMORY button will glow steady for one second and then flash once when the settings are complete. Then the light will go off.
3. Set the climate control temperature, fan speed and mode settings, radio presets, tone, volume, playback mode (AM/FM, tape or CD), tape direction and compact disc position.

Your memory settings are now programmed. Any changes that are made to the audio system and climate controls while driving will be automatically stored when the ignition key is turned off.

When first entering your vehicle, after pressing the unlock button on your remote keyless entry transmitter or a MEMORY button, a recall of your settings will occur when the door is closed and the ignition key is in the ignition switch. As the memory settings are recalled, the light above the button will flash until the correct settings are achieved, then glow for five seconds when complete.

A memory recall can be stopped by pressing any memory seat, mirror or steering column position button.

Drivers 1, 2 and 3 correspond to the order in which your remote keyless entry transmitters were programmed. See *Remote Keyless Entry System on page 2-5* for more information.

Memory recall will not work if the vehicle is moving. Memory recall will be temporarily interrupted during engine crank.

If easy entry is on, you must press the MEMORY button to reset the seat.

Section 3 Instrument Panel

Instrument Panel Overview	3-2	Traction Control System (TCS) Warning Light	3-39
Hazard Warning Flashers	3-4	Active Handling System Light	3-40
Other Warning Devices	3-5	Engine Coolant Temperature Gage	3-41
Horn	3-5	Malfunction Indicator Lamp	3-41
Tilt Wheel	3-5	Engine Oil Pressure Gage	3-44
Turn Signal/Multifunction Lever	3-6	Security Light	3-45
Exterior Lamps	3-13	Check Gages Warning Light	3-46
Interior Lamps	3-17	Fuel Gage	3-46
Head-Up Display (HUD)	3-18	Driver Information Center (DIC)	3-48
Accessory Power Outlets	3-22	DIC Controls and Displays	3-49
Ashtrays and Cigarette Lighter	3-23	DIC Warnings and Messages	3-58
Climate Controls	3-23	Other Messages	3-68
Dual Automatic Climate Control System	3-23	Audio System(s)	3-69
Outlet Adjustment	3-31	Setting the Time	3-69
Warning Lights, Gages and Indicators	3-32	Radio with Cassette	3-70
Warning Lights, Gages, and Indicators	3-32	Radio with CD	3-76
Instrument Panel Cluster	3-33	Trunk-Mounted CD Changer	3-81
Speedometer and Odometer	3-34	Theft-Deterrent Feature	3-86
Tachometer	3-34	Radio Reception	3-88
Safety Belt Reminder Light	3-34	Care of Your Cassette Tape Player	3-88
Air Bag Readiness Light	3-35	Care of Your CDs	3-89
Air Bag Off Light	3-36	Care of Your CD Player	3-89
Voltmeter Gage	3-37	Fixed Mast Antenna (Z06)	3-89
Brake System Warning Light	3-38	Power Antenna Mast Care (Convertible)	3-90
Anti-Lock Brake System Warning Light	3-39	Integrated Windshield and Rear Window Antennas (Coupe)	3-90

Instrument Panel Overview

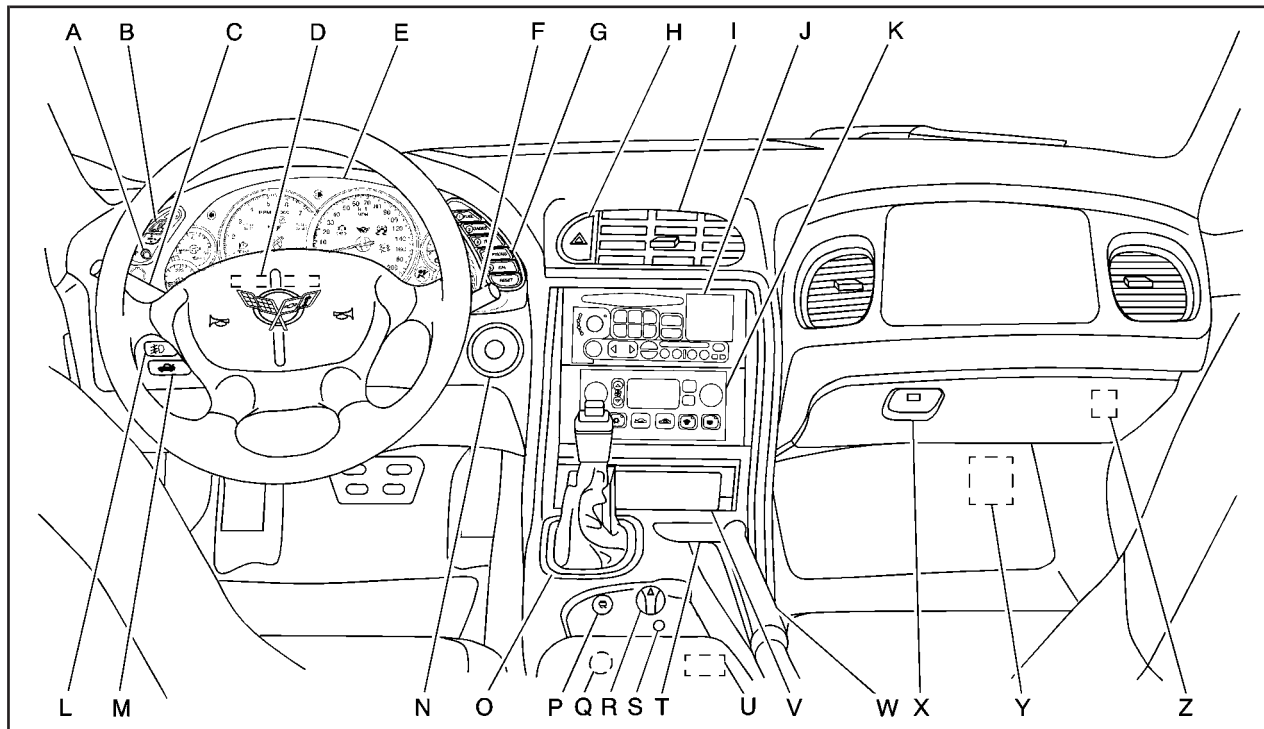

The main components of your instrument panel are the following:

- A. Instrument Panel Brightness Control. See “Instrument Panel Brightness” under *Interior Lamps* on page 3-17.
- B. Head-Up Display Controls. See *Head-Up Display (HUD)* on page 3-18.
- C. Turn Signal/Multifunction Lever. See *Turn Signal/Multifunction Lever* on page 3-6.
- D. Driver Information Center (DIC). See *Driver Information Center (DIC)* on page 3-48.
- E. Instrument Panel Cluster. See *Instrument Panel Cluster* on page 3-33.
- F. Windshield Wiper/Washer Lever. See “Windshield Wipers” under *Turn Signal/Multifunction Lever* on page 3-6.
- G. Driver Information Center (DIC) Controls. See *Driver Information Center (DIC)* on page 3-48.
- H. Hazard Warning Flasher Button. See *Hazard Warning Flashers* on page 3-4.
- I. Center Air Outlets. See *Outlet Adjustment* on page 3-31.
- J. Audio System. See *Audio System(s)* on page 3-69.
- K. Climate Controls. See *Dual Automatic Climate Control System* on page 3-23.
- L. Fog Lamp Button. See “Fog Lamps” under *Exterior Lamps* on page 3-13.
- M. Hatch/Trunk Release Button. See “Hatch/Trunk Lid Release” under *Hatch/Trunk* on page 2-11.
- N. Ignition Switch. See *Ignition Positions* on page 2-20.
- O. Shift Lever (Automatic Shown). See *Automatic Transmission Operation* on page 2-25 or *Manual Transmission Operation* on page 2-28.
- P. Active Handling Button. See *Active Handling System* on page 4-10.
- Q. Accessory Power Outlet. See *Accessory Power Outlets* on page 3-22.
- R. Selective Ride Control Switch. See *Selective Ride Control* on page 4-12.
- S. Air Bag Off Light. See *Air Bag Off Light* on page 3-36.
- T. Instrument Panel Cupholder. See *Cupholder(s)* on page 2-40.
- U. Fuel Door Release Button. See *Filling Your Tank* on page 5-7.
- V. Ashtray and Cigarette Lighter. See *Ashtrays and Cigarette Lighter* on page 3-23.
- W. Parking Brake. See *Parking Brake* on page 2-31.
- X. Glove Box. See *Glove Box* on page 2-40.
- Y. Instrument Panel Fuse Block. See “Instrument Panel Fuse Block” under *Fuses and Circuit Breakers* on page 5-93.
- Z. Air Bag Off Switch. See *Air Bag Off Switch* on page 1-46.

Hazard Warning Flashers

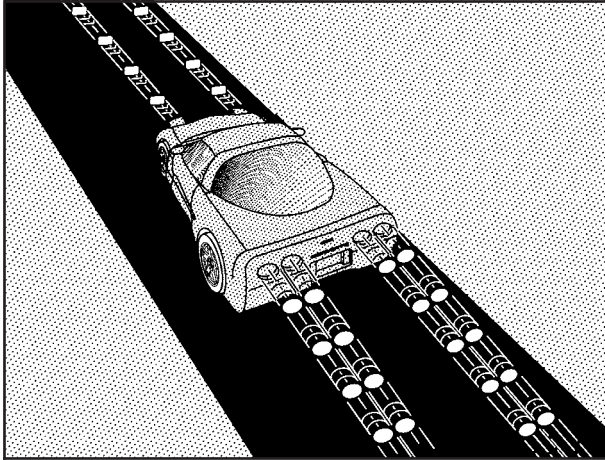

Your hazard warning flashers let you warn others. They also let police know you have a problem. Your front and rear turn signal lamps will flash on and off.



The hazard warning flasher button is located on the instrument panel above the audio system.

Your hazard warning flashers work no matter what position your key is in, and even if the key isn't in the ignition.

Press the button to make the front and rear turn signal lamps flash on and off. Press the button again to turn the flashers off.

When the hazard warning flashers are on, your turn signals won't work.

Other Warning Devices

If you carry reflective triangles, you can set one up at the side of the road about 300 feet (100 m) behind your vehicle.

Horn

To sound the horn, press either horn symbol on the steering wheel.

Tilt Wheel

A tilt wheel allows you to adjust the steering wheel before you drive. You can raise it to the highest level to give your legs more room when you exit and enter the vehicle.

The lever that allows you to tilt the steering wheel is located on the left side of the steering column.



To tilt the wheel, hold the steering wheel and pull the lever toward you. Then move the wheel to a comfortable position and release the lever to lock the wheel in place.

Telescopic Steering Column

If your vehicle has this feature, the telescopic steering column will allow you to adjust the distance the steering wheel is from the instrument panel.

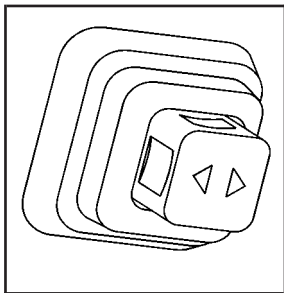

The telescopic steering column switch is located on the right side of the steering column.

To operate the telescopic steering column, push the switch forward and the wheel will move away from you. Pull the switch rearward and the wheel will move toward you.

The telescopic steering column position can be stored with your memory settings. See *Memory* on page 2-57 for more information.

Turn Signal/Multifunction Lever

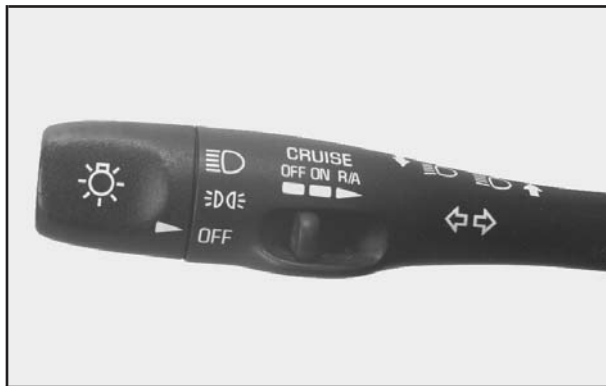

The lever on the left side of the steering column includes the following:

- Turn and Lane-Change Signals
- Headlamp High/Low-Beam Changer
- Flash-to-Pass Feature
- Cruise Control

For information on exterior lamps, see *Exterior Lamps* on page 3-13.

Turn and Lane-Change Signals

The turn signal has two upward (for right) and two downward (for left) positions. These positions allow you to signal a turn or a lane change.

To signal a turn, move the multifunction lever all the way up or down. When the turn is finished, the lever will return automatically.

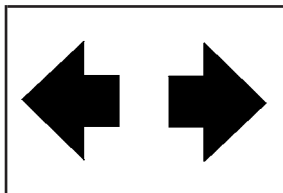

An arrow on the instrument panel cluster will flash in the direction of the turn or lane change.

To signal a lane change, just raise or lower the lever until the arrow starts to flash. Hold it there until you complete your lane change. The lever will return by itself when you release it.

If you signal a turn or a lane change and the arrows flash faster than normal, a signal bulb may be burned out.

If a bulb is burned out, replace it to help avoid an accident. If the arrows do not go on at all when you signal a turn, check the fuses and check for burned-out bulbs. See *Fuses and Circuit Breakers* on page 5-93.

Turn Signal on Chime

A chime will remind you if you leave the turn signal on for more than 3/4 mile (1.2 km) of driving.

If you need to leave the turn signal on for more than 3/4 mile (1.2 km), turn off the signal and then turn it back on.

Headlamp High/Low-Beam Changer

To change the headlamps from low beam to high or high to low, push the turn signal lever all the way forward.

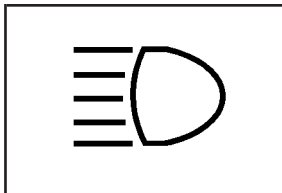

While the high beams are on, this light on the instrument panel cluster also will be on. To change the headlamps from high to low, pull the lever rearward.

Headlamps on Reminder

If you turn the ignition off and leave the headlamps or parking lamps on and open a door, you will hear a chime reminding you to turn off the lamps.

Flash-to-Pass

To use the flash-to-pass feature, momentarily pull the turn signal lever toward you. The high-beam indicator will flash to indicate to the other driver that you intend to pass. If the low-beam headlamps are off and you have the optional fog lamps on, the fog lamps will flash.

Windshield Wipers

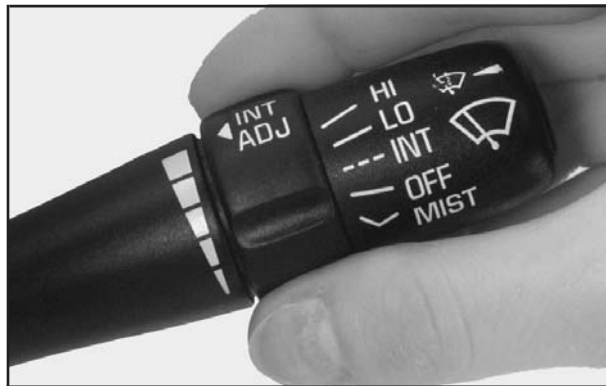

Use this lever located on the right side of the steering column to operate the windshield wipers.

OFF: Move the lever to OFF to turn off the windshield wipers.

INT (Intermittent): Move the lever to INT to choose a delayed wiping cycle. Turn the INT ADJ band down for a longer delay or up for a shorter delay. The further the INT ADJ band is turned upward, the shorter the delay will be and the further the INT ADJ band is turned downward, the longer the delay will be.

The wiper speed can only be adjusted when the lever is in the INT position. Use this position for light rain or snow.

LO (Low Speed): Move the lever up to the first setting past INT, for steady wiping at low speed.

HI (High Speed): Move the lever up to the second setting past INT, for steady wiping at high speed.

MIST: Move the lever all the way down to MIST for a single wiping cycle. Hold it there until the windshield wipers start; then let go. The windshield wipers will stop after one wipe. If you want more wipes, hold the band on MIST longer.

Heavy snow or ice can overload the wipers. If this occurs, a circuit breaker will stop the wipers until the motor cools. So, be sure to clear any ice and snow from the windshield wiper blades before using them. If the wiper blades are frozen to the windshield, carefully loosen them or warm the windshield before turning the wipers on. If your blades do become worn or damaged, get new blades or blade inserts.

Windshield Washer

The lever on the right side of the steering column also controls the windshield washer. There is a button at the end of the lever. To spray washer fluid on the windshield, press the button and hold it. The washer will spray until you release the button. The wipers will continue to clear the window for about six seconds after the button is released and then stop or return to your preset speed.

CAUTION:

In freezing weather, do not use your washer until the windshield is warmed. Otherwise the washer fluid can form ice on the windshield, blocking your vision.

If the fluid in the windshield washer fluid reservoir is low, the message LOW WASHER FLUID will appear on the Driver Information Center (DIC) display. It will take 60 seconds after the bottle is refilled for this message to turn off. For information on the correct washer fluid to use, see *Windshield Washer Fluid on page 5-36* and *Recommended Fluids and Lubricants on page 6-11*.

Cruise Control

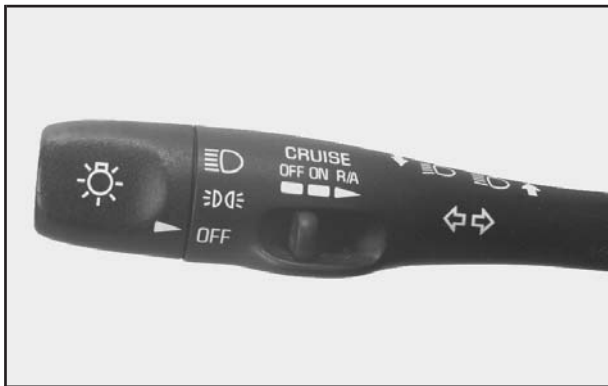

With cruise control, you can maintain a speed of about 25 mph (40 km/h) or more without keeping your foot on the accelerator. This can really help on long trips. Cruise control does not work at speeds below about 25 mph (40 km/h).

When using cruise control, the accelerator pedal will return to its fully-released position and will not move while cruise control is engaged.

The Driver Information Center (DIC) will display the cruise set speed in a digital number. For example, the DIC will say CRUISE SET 60 mph (97 km/h).

The cruise set speed and the speedometer indicated speed may not always be exactly the same. When you apply the brakes or push the clutch pedal, the cruise control disengages. The DIC will show CRUISE DISENGAGED. See *DIC Warnings and Messages on page 3-58*.

CAUTION:

Cruise control can be dangerous where you can not drive safely at a steady speed. So, do not use your cruise control on winding roads or in heavy traffic.

Cruise control can be dangerous on slippery roads. On such roads, fast changes in tire traction can cause needless wheel spinning, and you could lose control. Do not use cruise control on slippery roads.

If your vehicle is in cruise control when the Traction Control System begins to limit wheel spin, the cruise control will automatically disengage. See *Traction Control System (TCS) on page 4-9*. When road conditions allow you to safely use it again, you may turn the cruise control back on.

Setting Cruise Control

CAUTION:

If you leave your cruise control on when you are not using cruise, you might hit a button and go into cruise when you do not want to. You could be startled and even lose control. Keep the cruise control switch off until you want to use cruise control.

1. Move the cruise control switch to ON.
2. Get up to the speed you want.
3. Press the SET button at the end of the lever and release it. The cruise set speed will be displayed by the Driver Information Center (DIC).
4. Take your foot off the accelerator pedal. The pedal will return to an idle position.

Resuming a Set Speed

Suppose you set the cruise control at a desired speed and then you apply the brake or clutch pedal. This, of course, disengages the cruise control. But you do not need to reset it.

Once you are going about 25 mph (40 km/h) or more, you can move the cruise control switch to R/A (Resume/Accelerate) briefly. The Driver Information Center (DIC) will display the cruise set speed.

You will go right back up to your chosen speed and stay there.

Increasing Speed While Using Cruise Control

There are two ways to go to a higher speed:

- Use the accelerator pedal to get to the higher speed. The speed will not begin to increase until sufficient pedal travel is achieved. Press the SET button at the end of the lever, then release the button and the accelerator pedal. You will now cruise at the higher speed.
- Move the cruise switch to R/A. Hold it there until you get up to the speed you want, then release the switch. (To increase your speed in very small amounts, move the switch to R/A briefly, then release it. Each time you do this, the vehicle will go about 1 mph (1.6 km/h) faster.)

The Driver Information Center (DIC) will display the cruise set speed.

Reducing Speed While Using Cruise Control

There are two ways to reduce speed while using cruise control:

- Press in the SET button at the end of the lever until you reach the lower speed you want, then release it.
- To slow down in very small amounts, press the SET button briefly. Each time you do this, you will go about 1 mph (1.6 km/h) slower.

The Driver Information Center (DIC) will display the cruise set speed.

Passing Another Vehicle While Using Cruise Control

Use the accelerator pedal to increase speed. When you take your foot off the pedal, the vehicle will slow down to the cruise control speed you set earlier.

Using Cruise Control on Hills

How well your cruise control will work on hills depends upon your speed, load and the steepness of the hills. When going downhill, you may have to brake or shift to a lower gear to keep your speed down. Of course, applying the brake takes you out of cruise control. Many drivers find this to be too much trouble and do not use cruise control on steep hills.

Ending Cruise Control

There are two ways to turn off the cruise control:

- Step lightly on the brake pedal or push the clutch pedal, if you have a manual transmission vehicle.
- Move the cruise switch to OFF.

The Driver Information Center (DIC) will display the message CRUISE DISENGAGED.

Erasing Speed Memory

When you turn off the cruise control or the ignition, cruise control set speed memory is erased.

Exterior Lamps

The exterior lamp switch on the turn signal/multifunction lever operates the headlamps.

The exterior lamp switch has three positions:

OFF: Turn the switch to this position to turn off all lamps, except the Daytime Running Lamps (DRL).

 **(Parking Lamps):** Turn the switch to this position to turn on the parking lamps, together with the following:

- Taillamps
- Parking Lamps
- Sidemarkers Lamps

 **(Headlamps):** Turn the switch to this position to turn on the headlamps, together with the previously listed lamps.

Headlamps Doors



The headlamp doors are designed to open when you turn the headlamps on, and close when you turn the headlamps and parking lamps off. If you turn the headlamps on, then turn back to the parking lamps setting, the headlamp doors will stay open.

You can open the doors manually using the knob next to the headlamp assembly. Turn the knob counterclockwise until the doors are open. Turn the knob clockwise to close the doors manually.

The headlamp doors should be open when driving in icy or snowy conditions to prevent the doors from freezing closed and when washing the vehicle to help clean the headlamps.

Notice: If the hood comes into contact with the headlamp doors when you raise the hood, you could damage the hood and/or the headlamp doors. Always close the headlamp doors before opening the hood.

Daytime Running Lamps

Daytime Running Lamps (DRL) can make it easier for others to see the front of your vehicle during the day. DRL can be helpful in many different driving conditions, but they can be especially helpful in the short periods after dawn and before sunset. Fully functional daytime running lamps are required on all vehicles first sold in Canada.

The DRL system will make the front turn signal lamps come on when the following conditions are met:

- The ignition is on,
- the exterior lamp switch is off and
- the parking brake is released.

When the DRL are on, only the front turn signal lamps will be on. The headlamps, taillamps, sidemarker and other lamps will not be on. Your instrument panel will not be lit up either.

To idle the vehicle with the DRL off, set the parking brake while the ignition is in OFF. Then start the vehicle. The DRL, headlamps and parking lamps will stay off until you release the parking brake.

As with any vehicle, you should turn on the regular headlamp system when you need it.

Fog Lamps



Your vehicle may have this feature. Use the fog lamps for better vision in foggy or misty conditions. Your parking lamps or low-beam headlamps must be on or the fog lamps will not work.

To turn the fog lamps on, press the button located on the instrument panel, to the left of the steering column. A light in the button will come on while the fog lamps are on. Press the button again to turn the fog lamps off.

Twilight Sentinel® (Optional in United States, Standard in Canada)

Twilight Sentinel® can turn your lamps on and off for you. A light sensor on top of the instrument panel makes the Twilight Sentinel® work, so be sure it is not covered.

You can customize your vehicle to turn Twilight Sentinel® on or off, except for vehicles first sold in Canada. See *Driver Information Center (DIC) on page 3-48* to turn this feature on or off.

When Twilight Sentinel® is turned on, you will see the following happen:

- When it is dark enough outside, the front turn signal lamps (DRL) will go off, and the headlamps and parking lamps will come on. The other lamps that come on with headlamps will also come on.
- When it is bright enough outside, the headlamps will go off, and the front turn signal lamps (DRL) will come on, as long as the exterior lamp switch is in the OFF position.

If you start your vehicle in a dark garage, the automatic headlamp system will come on immediately. Once you leave the garage, it will take about one minute for the automatic headlamp system to change to DRL if it is light outside. During that delay, your instrument panel cluster may not be as bright as usual.

Make sure your instrument panel brightness control is in full bright position. See “Instrument Panel Brightness Control” under *Interior Lamps on page 3-17*.

With Twilight Sentinel® turned on, you can idle the vehicle with the lamps off, even when it is dark outside. First set the parking brake while the ignition is in OFF. Then start the vehicle. The lamps will stay off until you release the parking brake.

Twilight Sentinel® also provides exterior illumination as you leave the vehicle. If Twilight Sentinel® has turned on the lamps when you turn off the ignition, your lamps will remain on until:

- The exterior lamp switch is moved from OFF to the parking lamp position, or
- a delay time that you select has elapsed.

See *Driver Information Center (DIC) on page 3-48* to select the delay time that you want. You can also select no delay time.

If you turn off the ignition with the exterior lamp switch in the parking lamp or headlamp position, the Twilight Sentinel® delay will not occur. The lamps will turn off as soon as the switch is turned off.

As with any vehicle, you should turn on the regular headlamp system when you need it.

Interior Lamps

Instrument Panel Brightness



The knob for this feature is located on the left side of the instrument panel.

Push the knob to release it from the stored position. Turn the knob clockwise to brighten the lights or counterclockwise to dim them.

Be sure not to have this knob turned all the way down with the lamps on during the day. Your Driver Information Center (DIC) may not be visible.

Parade Mode

The instrument panel brightness knob has an added feature called parade mode to assist you in seeing certain instrument panel controls if your headlamps are on in the daylight. Turn the knob counterclockwise to dim the instrument panel lights or clockwise to brighten the lights. This will occur only with the parking lamps or headlamps on.

Courtesy Lamps

When any door or the hatch/trunk lid is opened, the interior lamps will go on unless it is bright outside.

You can also turn on the courtesy lamps by turning the instrument panel brightness knob all the way clockwise.

Exit/Entry Lighting

With entry lighting, the interior lamps will come on when entering the vehicle. The interior lamps will come on for about 20 seconds when the key is turned to OFF or a door is ajar.

You can turn exit and entry lighting off by quickly turning the headlamps on and off or by quickly turning the courtesy lamps on and off.

Reading Lamps



Your inside rearview mirror includes two reading lamps. The lamps will go on when a door is opened. When the doors are closed, each lamp can be turned on individually by pressing the switch for that lamp.

There is also an interior console flood lamp located underneath the rearview mirror which comes on during nighttime operation or when the reading lamps are on.

Battery Run-Down Protection

Your vehicle has a feature to help prevent you from draining the battery in case the underhood lamp, vanity mirror lamps, cargo lamps, reading lamps, console or glove box lamps are accidentally left on. If you leave any of these lamps on, they will automatically timeout after about 15 minutes. To reset it, all of the above lamps must be turned off or the ignition key must be in ON.

Head-Up Display (HUD)

CAUTION:

If the HUD image is too bright, or too high in your field of view, it may take you more time to see things you need to see when it is dark outside. Be sure to keep the HUD image dim and placed low in your field of view.

If your vehicle is equipped with the Head-Up Display (HUD), you can see some of the driver information that appears on your instrument panel cluster.

The information may be displayed in English or metric units and appears as an image focused out toward the front of your vehicle. The HUD consists of the following information:

- Speedometer
- Turn Signal Indicators
- High-Beam Indicator Symbol
- Tachometer
- Oil, Temperature and Fuel Gages
- Shift Light (Performance SHIFT Light)

This light is used for performance driving to indicate that the vehicle's best performance level has been reached to shift the transmission into the next higher gear. The SHIFT light will display at an engine speed of about 5,750 rpm (6,250 rpm on Z06), just prior to reaching the engine fuel cut-off mode.

- Check Gages Icon

There are five HUD selections that you can choose to view in the HUD display. By pressing and holding the PAGE button, you can scroll through these pages in the following order:

- Speed Only
- Speed and Gage
- Speed, Tachometer and Gage
- Speed and Tachometer
- Tachometer Only

When you have chosen the desired HUD display, release the PAGE button.

Gages can be scrolled through by tapping the PAGE button (only when a gage is displayed). The gages shown are the following:

- Oil Pressure
- Coolant Temperature
- Fuel Level

The selections that you choose will remain in the HUD display until they are changed.

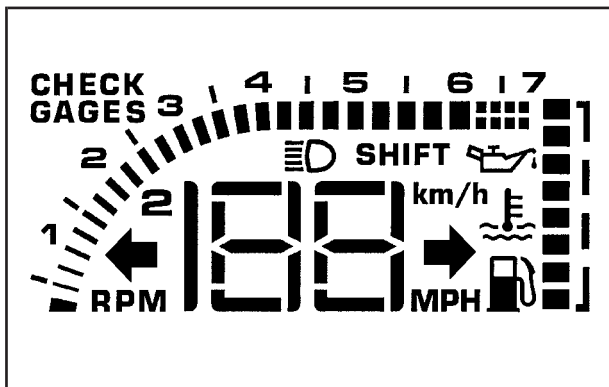

Be sure to continue scanning your displays, controls and driving environment just as you would in a vehicle without HUD. If you never look at your instrument panel cluster, you may not see something important, such as a warning light. Under important warning conditions, the CHECK GAGES icon will illuminate in the HUD. View your Driver Information Center (DIC) for more information.

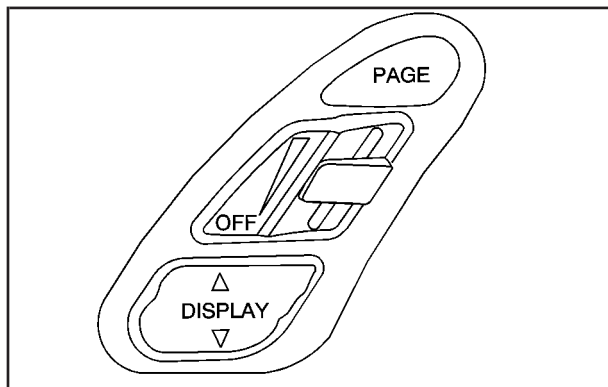

The HUD controls are located to the left of the steering wheel.

To adjust the HUD so you can see it properly, do the following:

1. Start your engine and slide the HUD dimmer control all the way up.

The brightness of the HUD image is determined by the light conditions in the direction your vehicle is facing and where you have the HUD dimmer control set. If you are facing a dark object or a heavily shaded area, your HUD may anticipate that you are entering a dark area and may begin to dim.

It is possible for sunlight to enter the HUD causing all of the graphics to light up. The display will return to normal when the sunlight is no longer entering the HUD.

2. Adjust the seat to a comfortable driving position. If you change your seat position later, you may have to re-adjust your HUD.
3. Press the top or bottom of the DISPLAY switch to center the HUD image in your view.
The HUD image can only be adjusted up and down, not side-to-side.
4. Slide the dimmer control downward until the HUD image is no brighter than necessary.

To turn HUD off, slide the switch to OFF.

If the sun comes out or it becomes cloudy, you may need to adjust the HUD brightness again using the dimmer control. Polarized sunglasses could make the HUD image harder to see.

To change from English to metric units, press the E/M button located to the right of the steering wheel.

Clean the inside of the windshield as needed to remove any dirt or film that reduces the sharpness or clarity of the HUD image.

To clean the HUD, spray household glass cleaner on a soft, clean cloth. Wipe the HUD lens gently, then dry it. Do not spray cleaner directly on the lens because the cleaner could leak into the unit.

If the ignition is on and you can't see the HUD image, check to see if:

- Something is covering the HUD unit.
- The HUD dimmer control is adjusted properly.
- The HUD image is adjusted to the proper height.
- Ambient light, in the direction your vehicle is facing, is low.
- A fuse is blown. See *Fuses and Circuit Breakers on page 5-93*.

Keep in mind that your windshield is part of the HUD system. If you ever have to have your windshield replaced, be sure to get one that is designed for HUD or your HUD image may look blurred and out of focus.

Accessory Power Outlets

The accessory power outlet can be used to connect electrical equipment such as a cellular phone or CB radio.

The accessory power outlet is located inside the center console storage compartment, on the forward left side.

To use the outlet, remove the tethered cap. When not using it, always cover the outlet with the protective cap.

Notice: Leaving electrical equipment on for extended periods will drain the battery. Always turn off electrical equipment when not in use and do not plug in equipment that exceeds the maximum amperage rating.

Certain electrical accessories may not be compatible with the accessory power outlet and could result in blown vehicle or adapter fuses. If you experience a problem, see your dealer for additional information on accessory power outlets.

Notice: Adding any electrical equipment to your vehicle may damage it or keep other components from working as they should. The repairs would not be covered by your warranty. Check with your dealer before adding electrical equipment.

When adding electrical equipment, be sure to follow the installation instructions included with the equipment.

We recommend that you see a qualified technician or your dealer for the proper installation of your equipment.

Notice: Improper use of the power outlet can cause damage not covered by your warranty. Do not hang any type of accessory or accessory bracket from the plug because the power outlets are designed for accessory power plugs only.

Ashtrays and Cigarette Lighter

The ashtray and cigarette lighter are located on the instrument panel, in front of the shift lever. To use the ashtray, lift up on the bottom of the door.

Notice: If you put papers or other flammable items in the ashtray, hot cigarettes or other smoking materials could ignite them and possibly damage your vehicle. Never put flammable items in the ashtray.

Loose objects, such as paper clips, can lodge behind and beneath the ashtray lid and prevent movement of the lid. You should avoid putting small, loose objects near the ashtray.

To use the cigarette lighter, push it in all the way and let go. When it is ready, it will pop back out by itself.

Notice: Holding a cigarette lighter in while it is heating will not allow the lighter to back away from the heating element when it is hot. Damage from overheating may occur to the lighter or heating element, or a fuse could be blown. Do not hold a cigarette lighter in while it is heating.

Climate Controls

Dual Automatic Climate Control System

With this system you can control the heating, cooling and ventilation for your vehicle.



When your vehicle is first started, the display will show the driver's temperature setting, the fan speed and the air delivery for about five seconds; then it will show the outside temperature.

The digital display will show readings in Fahrenheit or Celsius by pressing the E/M (English/metric) button on the Driver Information Center (DIC).

Automatic Operation

AUTO (Automatic): Press the AUTO button to place the entire system in the automatic mode. When automatic operation is active, the system will automatically control the inside temperature, the air delivery mode and the fan speed.

After a five-second display of the current settings, only the word AUTO and the outside temperature will be shown on the digital display unless the system is set to full cold 60°F (16°C) or full hot 90°F (32°C), then the word AUTO will not display. The system will operate to achieve your comfort set temperature as quickly as possible. The AUTO control system works best with the windows up and the removable roof installed or the convertible top up.

1. Press the AUTO button.
2. Adjust the temperature to a comfortable setting between 60°F (16°C) or full hot 90°F (32°C).

Choosing the coldest or warmest temperature setting will not cause the system to heat or cool any faster. If you set the system at the coldest or warmest temperature setting, the system will remain in manual mode at that temperature and it will not go into automatic mode.

In cold weather, the system will start at reduced fan speeds to avoid blowing cold air into your vehicle until warmer air is available. The system will start out blowing air at the floor but may change modes automatically as the vehicle warms up to maintain the chosen temperature setting. The length of time needed for warm up will depend on the outside temperature and the length of time that has elapsed since your vehicle was last driven.

3. Wait for the system to regulate. This may take from 10 to 30 minutes. Then adjust the temperature, if necessary.

Do not cover the solar sensor located in the center of the instrument panel, near the windshield. For more information on the solar sensor, see "Sensor" later in this section.

Manual Operation

OFF: Press this button to turn off the climate control system. This is the only setting that fully shuts off the fan. The digital display will show only the outside temperature. You can still adjust the driver's set temperature, the passenger temperature offset and the air intake mode while in OFF.

MODE: Press this button to manually lock in the current air delivery setting and to stop the automatic mode control. Pressing the MODE button will delete AUTO from the digital display and the mode graphics will be shown. To change the setting, press the MODE button again. The AUTO button must be pressed to return to the automatic mode selection.

To change the current mode, select one of the following:

 **(Vent):** This mode directs most of the air to the instrument panel outlets, with a very small amount of air directed to the floor outlets.

 **(Bi-Level):** This mode directs about half of the air to the instrument panel outlets, and then directs most of the remaining air to the floor outlets. Some air may be directed toward the windshield. Cooler air is directed to the upper outlets and warmer air to the floor outlets.

 **(Floor):** This mode directs most of the air to the floor outlets with some air directed to the outboard outlets (for the side windows) and some air directed to the windshield.

The MODE button can also be used to select the defog mode. Information on defogging and defrosting can be found later in this section.

 **(Fan):** Press the button with the fan symbol to manually increase or decrease the fan speed. Keep pressing the up or down arrow on this switch until the desired fan speed appears on the display.

Pressing the arrows will delete AUTO from the digital display. The fan graphics with the fan speed bars will be shown. To increase the fan speed so that more air flows into the vehicle, press the up arrow on the fan switch. To decrease the fan speed and airflow, press the down arrow. The AUTO button must be pressed to return to the automatic fan control.

 **(Outside Air):** Press this button to turn the outside air mode on or off. When this mode is on, outside air will circulate throughout your vehicle. When the button is pressed, an indicator light in the button will come on to let you know that it is activated. The outside air mode can be used with all modes, but cannot be used with the recirculation mode.

When in the AUTO mode, the system automatically selects outside air instead of recirculation, as required, to control the temperature in the vehicle. By pressing outside air, the system will lock into the outside air mode. Any adjustment to the air intake must then be made manually. Outside air should be used when trying to defrost or defog windows to help reduce moisture inside of the vehicle.

If you are in city traffic, your vehicle is stopped and idling, or the weather is hot, the system may switch from the outside air mode to the recirculation mode. To prevent the air inside of your vehicle from becoming stale, be sure to return to the outside air mode periodically.

 **(Recirculation):** This mode keeps outside air from coming in the vehicle. It can be used to prevent outside air and odors from entering your vehicle or to help cool the air inside your vehicle more quickly. Press this button to turn the recirculation mode on or off. When the button is pressed, an indicator light will come on. The air-conditioning compressor also comes on. The recirculation mode cannot be used with the outside air mode.

When in the AUTO mode, the system automatically selects recirculation to cool the vehicle's temperature. By pressing this button, the system will lock into recirculation mode. Any adjustment to the air intake must then be made manually. Recirculation is not available when using the defrost or defog mode because outside air is needed to reduce moisture inside of the vehicle.

Operating the system in the recirculation mode may cause fogging of the vehicle's windows when the weather is cold and damp. To clear the fog, switch the system to either the defog or defrost mode and increase the fan speed. To avoid re-fogging of the windows, operate the system in the outside air mode.

Temperature Control: The DRIVER knob changes the temperature on the driver's and passenger's side of the vehicle. Turn the knob clockwise or counterclockwise to manually increase or decrease the temperature inside your vehicle. Whenever you turn this knob, the temperature will be displayed for about five seconds along with the current fan speed and air delivery mode.

The PASSENGER knob changes the temperature on the passenger's side of the vehicle. When the knob is in the 12 o'clock position, the passenger's temperature is the same as the driver's. Turn the knob clockwise for warmer air on the passenger's side or counterclockwise for cooler air. If the driver-set temperature is set at full cold 60°F (16°C) or full hot 90°F (32°C), turning the PASSENGER knob has no effect because the system is locked at a maximum setting.

 **A/C (Air Conditioning):** Press this button to override the automatic system and turn the air-conditioning system on or off. When A/C is pressed, an indicator light in the button will come on to let you know that the air conditioning is activated. When in AUTO, the air-conditioning compressor will come on automatically, as necessary.

Air conditioning does not operate at temperatures below about 35°F to 40°F (2°C to 4°C). In temperatures above 40°F (4°C), the air conditioning cannot be turned off in defrost and defog, as it helps to remove moisture from the vehicle. It also helps to keep the windows clear.

You may notice a slight change in engine performance when the air-conditioning compressor shuts off and turns on again. This is normal. The system is designed to make adjustments to help with fuel economy while still maintaining the selected temperature.

On hot days, open the windows to let hot inside air escape; then close them. This helps to reduce the time it takes for your vehicle to cool down. It also helps the system to operate more efficiently.

For quick cool down on hot days, do the following:

1. Select the vent mode.
2. Select recirculation mode.
3. Select the A/C.
4. Select the coolest temperature.
5. Select the highest fan speed.

Using these settings together for long periods of time may cause the air inside of your vehicle to become too dry. To prevent this from happening, after the air in your vehicle has cooled, turn the recirculation mode off.

The air-conditioning system removes moisture from the air, so you may sometimes notice a small amount of water dripping underneath your vehicle while idling or after turning off the engine. This is normal.

Sensors

The solar sensor on your vehicle monitors the solar radiation and uses the information to maintain the selected temperature when operating in AUTO mode by initiating needed adjustments to the temperature, the fan speed and the air delivery system. The system may also supply cooler air to the side of the vehicle facing the sun. The recirculation mode will also be activated, as necessary. Do not cover the solar sensor located on the top right side of the instrument panel near the windshield or the system will not work properly.

There is also a sensor located behind the front bumper. This sensor reads the outside air temperature and helps to maintain the temperature inside the vehicle. Any cover on the front of the vehicle could give a false reading in the temperature.

If the outside temperature goes up, the displayed temperature will not change until:

- The vehicle's speed is above 16 mph (26 km/h) for one and a half minutes.
- The vehicle's speed is above 45 mph (72 km/h) for one minute.

These delays prevent false readings. If the temperature goes down, the outside temperature will be shown when you start the vehicle. If it has been turned off for less than three hours, the temperature will be recalled from the previous vehicle operation.

There is also an inside temperature sensor located to the left of the ignition switch. The automatic climate control system uses this sensor to receive information, so if you block or cover it, the system will not function properly.

Defogging and Defrosting

Fog on the inside of windows is a result of high humidity (moisture) condensing on the cool window glass.

This can be minimized if the climate control system is used properly. There are two modes to clear fog or frost from your windshield. Use the defog mode to clear the windows of fog or moisture and warm the passengers. Use FRONT to remove fog or frost from the windshield more quickly.

Press the MODE button until the defog mode appears on the display.

 **(Defog):** This mode directs the air equally between the windshield and the floor outlets with a small amount to the side window outlets. When you select this mode, the system turns off recirculation and runs the air-conditioning compressor unless the outside temperature is at or below freezing. An indicator light in the A/C button will come on to let you know that the air-conditioning compressor is activated. The recirculation mode cannot be selected while in the defog mode.



FRONT: Pressing this button directs most of the air to the windshield, with a small amount directed to the side window outlets. The light on the button will come on and the digital display will show the defrost mode symbol and fan speed when the front defrost mode is being used. In this mode, the system will automatically turn off the recirculation and run the air-conditioning compressor, unless the outside temperature is at or below freezing. An indicator light in the A/C button will come on to let you know that the air-conditioning compressor is activated. Recirculation cannot be selected while in the defrost mode. Pressing this button again will return the system to the last operating mode and the air intake mode will be in outside air.

If the system is in FRONT defrost when you shut the engine off, it will restart in FRONT defrost unless the engine is off for longer than 40 minutes. If the engine is off longer than 40 minutes, the system will restart in the operating mode that was set prior to FRONT defrost and the air intake mode will be in outside air. Do not drive the vehicle until all the windows are clear.

Rear Window Defogger

The rear window defogger uses a warming grid to remove fog or frost from the rear window.

The rear window defogger will only work when the engine is running.

 **REAR:** Press this button to turn the rear window defogger on. Be sure to clear as much snow from the rear window as possible. An indicator light in the button will come on to let you know that the rear window defogger is activated.

The rear window defogger will automatically turn off about 15 minutes after the button is pressed. If turned on again, the defogger will only run for about seven minutes before turning off. The defogger can also be turned off by pressing the button again or by turning off the engine.

Your vehicle has heated outside rearview mirrors. The mirrors will heat to help clear fog or frost from the surface of the mirrors when the rear window defog button is pressed.

Notice: Don't use anything sharp on the inside of the rear window. If you do, you could cut or damage the warming grid, and the repairs wouldn't be covered by your warranty. Do not attach a temporary vehicle license, tape, a decal or anything similar to the defogger grid.

Outlet Adjustment

Use the tab located on the air outlets to change the direction of the airflow.

Operation Tips

- Clear away any ice, snow or leaves from the air inlets at the base of the windshield that may block the flow of air into your vehicle.
- Use of non-GM approved hood deflectors may adversely affect the performance of the system.
- Keep the area around the base of the instrument panel console and air path under the seats clear of objects to help circulate the air inside of your vehicle more effectively.

Warning Lights, Gages and Indicators

Warning Lights, Gages, and Indicators

This part describes the warning lights and gages that may be on your vehicle. The pictures will help you locate them.

Warning lights and gages can signal that something is wrong before it becomes serious enough to cause an expensive repair or replacement. Paying attention to your warning lights and gages could also save you or others from injury.

Warning lights come on when there may be or is a problem with one of your vehicle's functions. As you will see in the details on the next few pages, some warning lights come on briefly when you start the engine just to let you know they're working. If you are familiar with this section, you should not be alarmed when this happens.

Gages can indicate when there may be or is a problem with one of your vehicle's functions. Often gages and warning lights work together to let you know when there's a problem with your vehicle.

When one of the warning lights comes on and stays on when you are driving, or when one of the gages shows there may be a problem, check the section that tells you what to do about it. Please follow this manual's advice. Waiting to do repairs can be costly — and even dangerous. So please get to know your warning lights and gages. They're a big help.

Your vehicle may also have a Driver Information Center that works along with the warning lights and gages. See *Driver Information Center (DIC) on page 3-48*.

Instrument Panel Cluster

Your instrument panel cluster and Driver Information Center (DIC) are designed to let you know at a glance how the vehicle is running. You will know how fast you are going, about how much fuel you have left and many other things you will need to know to drive safely and economically. The instrument panel cluster indicator warning lights, gages and DIC messages are explained on the following pages.

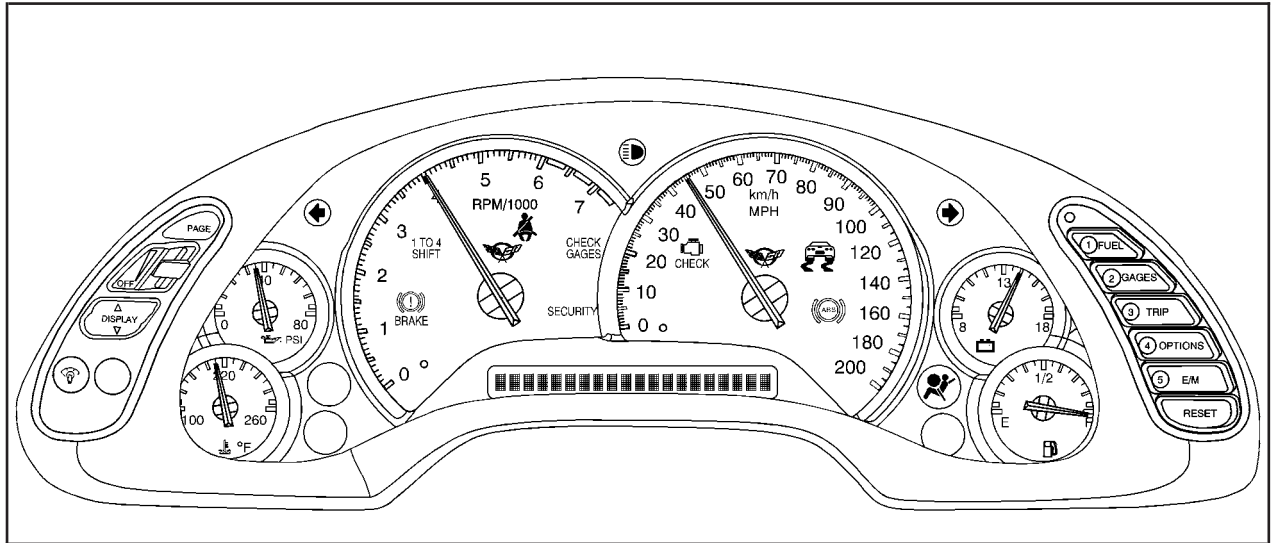

United States shown, Canada similar

Speedometer and Odometer

Your speedometer lets you see your speed in either miles per hour (mph) or kilometers per hour (km/h).

There is only one scale for mph and km/h. When you press the E/M (English/metric) button on the Driver Information Center (DIC), the cluster will calculate the proper speed and move the needle to the correct position. Either the MPH or the km/h telltale will illuminate, depending on which measurement you choose.

To read the odometer with the ignition off, turn on the parking lamps.

You may wonder what happens if your vehicle needs a new odometer installed. The mileage total of the new odometer will be set to the original miles (kilometers) of the old odometer. See your dealer if the odometer must be replaced in your vehicle.

Tachometer

The tachometer displays the engine speed in thousands of revolutions per minute (rpm).

Fuel will shut off at about 6200 rpm (6500 rpm for Z06).

If you continue to drive your vehicle at the fuel shut off rpm, you could damage your engine. Be sure to operate your vehicle below the fuel shut off rpm or reduce your rpm quickly when the fuel shuts off.

Safety Belt Reminder Light

When the key is turned to ON or START, a chime will come on for several seconds to remind people to fasten their safety belts, unless the driver's safety belt is already buckled.



The safety belt light will also come on and stay on until the driver's belt is buckled.

Air Bag Readiness Light

There is an air bag readiness light on the instrument panel, which shows a deployed air bag symbol. The system checks the air bag's electrical system for malfunctions. The light tells you if there is an electrical problem. The system check includes the air bag modules, the wiring and the diagnostic module. For more information on the air bag system, see *Air Bag System* on page 1-40.

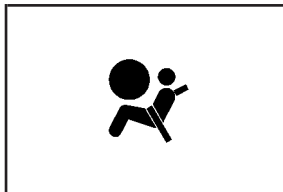

This light will come on when you start your vehicle, and it will flash for a few seconds. Then the light should go out. This means the system is ready.

If the air bag readiness light stays on after you start the vehicle or comes on when you are driving, your air bag system may not work properly. Have your vehicle serviced right away.

CAUTION:

If the air bag readiness light stays on after you start your vehicle, it means the air bag system may not be working properly. The air bags in your vehicle may not inflate in a crash, or they could even inflate without a crash. To help avoid injury to yourself or others, have your vehicle serviced right away if the air bag readiness light stays on after you start your vehicle.

The air bag readiness light should flash for a few seconds when you turn the ignition key to ON. If the light does not come on then, have it fixed so it will be ready to warn you if there is a problem.

Air Bag Off Light

When you turn the passenger's air bag off, this light will come on and stay on to remind you that the air bag has been turned off. This light will go off when you turn the air bag back on again. See *Air Bag Off Switch* on page 1-46 for more on this, including important safety information.



CAUTION:

If the passenger's air bag is turned off for a person who isn't in a risk group identified by the national government, that person won't have the extra protection of an air bag. In a crash, the air bag wouldn't be able to inflate and help protect the person sitting there. Don't turn off the passenger's air bag unless the person sitting there is in a risk group. See "Air Bag Off Switch" in the Index for more on this, including important safety information.

CAUTION:

If the air bag readiness light ever comes on when you have turned off the air bag, it means that something may be wrong with the air bag system. The passenger's air bag could inflate even though the switch is off. If this ever happens, don't let anyone whom the national government has identified as a member of a passenger air bag risk group sit in the passenger's position (for example, don't secure a rear-facing child restraint in your vehicle) until you have your vehicle serviced. See "Air Bag Off Switch" in the Index.

Voltmeter Gage

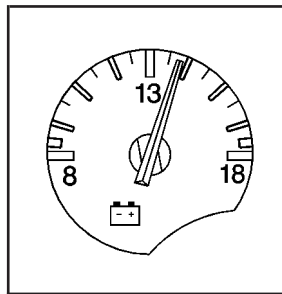

When the key is in ON with the engine not running, the voltmeter shows the voltage output of your battery. When the engine is running, it shows the voltage output of the charging system.

The reading will change as the rate of charge changes (with engine speed, for example), but if the voltmeter reads at 9 volts or below, your instrument panel cluster and other systems may shut down. The Driver Information Center (DIC) will read LOW VOLTAGE when your vehicle is at 10 volts or below. Have it checked right away. Driving with the voltmeter reading at 10 volts or below could drain your battery and disable your vehicle.

Brake System Warning Light

Your vehicle's hydraulic brake system is divided into two parts. If one part is not working, the other part can still work and stop you. For good braking, though, you need both parts working well.



This light should come on when you turn the ignition key to START. If it does not come on then, have it fixed so it will be ready to warn you if there is a problem.

If this warning light stays on after you start the engine, the parking brake may still be set or there could be a brake problem. Refer to *Parking Brake on page 2-31* to see if it is set. If the parking brake is not set, have your brake system inspected right away.

If the light comes on while you are driving and you have a LOW BRAKE FLUID message showing on the DIC, pull off the road and stop carefully. You may notice that the pedal is harder to push. Or, the pedal may go closer to the floor. It may take longer to stop. If the light is still on, have the vehicle towed for service. See *Towing Your Vehicle on page 4-33*.

CAUTION:

Your brake system may not be working properly if the brake system warning light is on. Driving with the brake system warning light on can lead to an accident. If the light is still on after you have pulled off the road and stopped carefully, have the vehicle towed for service.

Anti-Lock Brake System Warning Light

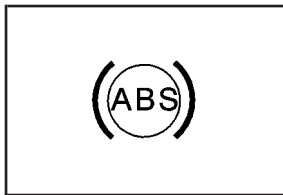

With the anti-lock brake system, the light will come on when your engine is started and may stay on for several seconds. That is normal.

If the light stays on, turn the ignition to OFF. Or, if the light comes on when you are driving, stop as soon as possible and turn the ignition off. Then start the engine again to reset the system. If the light still stays on, or comes on again while you are driving, your vehicle needs service. If the regular brake system warning light is not on, you still have brakes, but you do not have anti-lock brakes. If the regular brake system warning light is also on, you do not have anti-lock brakes and there is a problem with your regular brakes. See *Brake System Warning Light on page 3-38*. Also see "Service ABS" under *DIC Warnings and Messages on page 3-58*.

The anti-lock brake system warning light will come on briefly when you turn the ignition key to ON. This is normal. If the light does not come on then, have it fixed so it will be ready to warn you if there is a problem.

Traction Control System (TCS) Warning Light

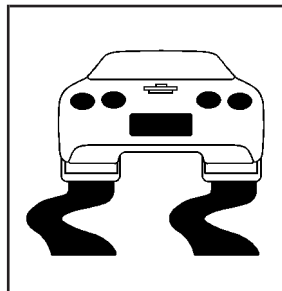

This light should come on briefly as you start the engine. If the light does not come on then, have it fixed so it will be ready to warn you if there is a problem.

If it stays on, or comes on and the DIC shows a SERVICE TRACTION SYSTEM message when you are driving, there is a problem with your TCS system and your vehicle needs service. When this light is on, the system will not limit wheel spin. Adjust your driving accordingly. If the driver turns off the Traction Control System by pressing the button on the console, the TCS system light will come on and the TRACTION SYSTEM OFF message will show on the DIC.

Active Handling System Light

The Active Handling System light will come on briefly as you start the engine. If the light does not come on then, have it fixed so it will be ready to warn you if there is a problem. The light will also come on while the system warms up and the ACT HNDLING WARMING UP message will be displayed in the Driver Information Center (DIC).

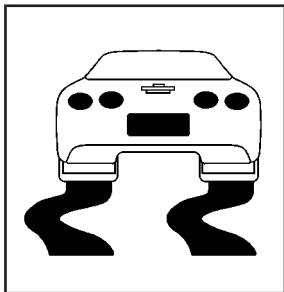

If the light stays on or comes on while you are driving, a chime sounds and a SERVICE ACTIVE HNDLG message appears on the DIC, there is a problem with your Active Handling System and your vehicle needs service.

The driver can acknowledge this message by pressing the RESET button. When the SERVICE ACTIVE HNDLG message is displayed, the Active Handling System will not assist you in controlling the vehicle. You should have the system serviced as soon as possible. Adjust your driving accordingly.

When the system is working, you will see the ACTIVE HANDLING message displayed in the DIC. You may also feel or hear the system working. This is normal.

If the driver turns off the Active Handling System by pressing the button on the console, the Active Handling System light will come on, a chime will sound, and the TRAC/ACT HNDLG OFF message will be displayed in the DIC. The Traction Control System will also be turned off. See *DIC Warnings and Messages on page 3-58* for more information.

If the Active Handling System and the Traction Control System are off, pressing the console button momentarily will turn both systems on. The DIC will display the TRAC/ACT HNDLG ON message, the instrument cluster light will be off, and a chime will sound. See *DIC Warnings and Messages on page 3-58* for more information.

Engine Coolant Temperature Gage

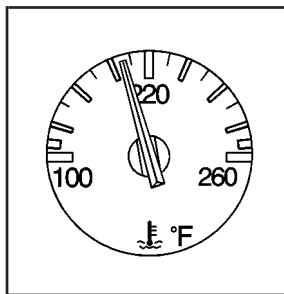

United States

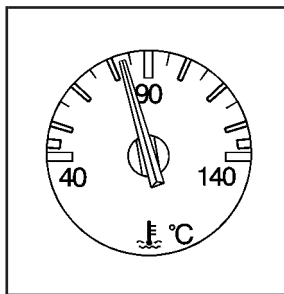

Canada

This gage shows the engine coolant temperature. If the gage pointer moves into the shaded area, your engine is too hot.

This means that your engine coolant has overheated. If you have been operating your vehicle under normal driving conditions, you should pull off the road, stop your vehicle and turn off the engine as soon as possible. (The larger tic marks are in increments of 30° below 220°F (104°C) and in increments of 10° above 220°F (104°C).)

See *Engine Overheating* on page 5-26 for more information.

Malfunction Indicator Lamp

Check Engine Light

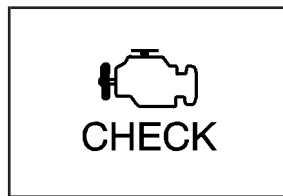

Your vehicle is equipped with a computer which monitors operation of the fuel, ignition and emission control systems.

This system is called OBD II (On-Board Diagnostics-Second Generation) and is intended to assure that emissions are at acceptable levels for the life of the vehicle, helping to produce a cleaner environment. The CHECK ENGINE light comes on to indicate that there is a problem and service is required. Malfunctions often will be indicated by the system before any problem is apparent. This may prevent more serious damage to your vehicle. This system is also designed to assist your service technician in correctly diagnosing any malfunction.

Notice: If you keep driving your vehicle with this light on, after a while, your emission controls may not work as well, your fuel economy may not be as good and your engine may not run as smoothly. This could lead to costly repairs that may not be covered by your warranty.

Notice: Modifications made to the engine, transmission, exhaust, intake or fuel system of your vehicle or the replacement of the original tires with other than those of the same Tire Performance Criteria (TPC) can affect your vehicle's emission controls and may cause this light to come on. Modifications to these systems could lead to costly repairs not covered by your warranty. This may also result in a failure to pass a required Emission Inspection/Maintenance test.

This light should come on, as a check to show you it is working, when the ignition is on and the engine is not running. If the light does not come on, have it repaired. This light will also come on during a malfunction in one of two ways:

- **Light Flashing** — A misfire condition has been detected. A misfire increases vehicle emissions and may damage the emission control system on your vehicle. Diagnosis and service may be required.
- **Light On Steady** — An emission control system malfunction has been detected on your vehicle. Diagnosis and service may be required.

If the Light Is Flashing

The following may prevent more serious damage to your vehicle:

- Reducing vehicle speed.
- Avoiding hard accelerations.
- Avoiding steep uphill grades.

If the light stops flashing and remains on steady, see "If the Light Is On Steady" following.

If the light continues to flash, when it is safe to do so, *stop the vehicle*. Find a safe place to park your vehicle. Turn the key off, wait at least 10 seconds and restart the engine. If the light remains on steady, see "If the Light Is On Steady" following. If the light is still flashing, follow the previous steps, and see your dealer for service as soon as possible.

If the Light Is On Steady

You also may be able to correct the emission system malfunction by considering the following:

Did you recently put fuel into your vehicle?

If so, reinstall the fuel cap, making sure to fully install the cap. See *Filling Your Tank on page 5-7*. The diagnostic system can determine if the fuel cap has been left off or improperly installed. A loose or missing fuel cap will allow fuel to evaporate into the atmosphere. A few driving trips with the cap properly installed should turn the light off.

Did you just drive through a deep puddle of water?

If so, your electrical system may be wet. The condition will usually be corrected when the electrical system dries out. A few driving trips should turn the light off.

Have you recently changed brands of fuel?

If so, be sure to fuel your vehicle with quality fuel. See *Gasoline Octane on page 5-4*. Poor fuel quality will cause your engine not to run as efficiently as designed. You may notice this as stalling after start-up, stalling when you put the vehicle into gear, misfiring, hesitation on acceleration or stumbling on acceleration. (These conditions may go away once the engine is warmed up.) This will be detected by the system and cause the light to turn on.

If you experience one or more of these conditions, change the fuel brand you use. It will require at least one full tank of the proper fuel to turn the light off.

If none of the above steps have made the light turn off, your dealer can check the vehicle. Your dealer has the proper test equipment and diagnostic tools to fix any mechanical or electrical problems that may have developed.

Emissions Inspection and Maintenance Programs

Some state/provincial and local governments have or may begin programs to inspect the emission control equipment on your vehicle. Failure to pass this inspection could prevent you from getting a vehicle registration.

Here are some things you need to know to help your vehicle pass an inspection:

Your vehicle will not pass this inspection if the CHECK ENGINE light is on or not working properly.

Your vehicle will not pass this inspection if the OBD (on-board diagnostic) system determines that critical emission control systems have not been completely diagnosed by the system. The vehicle would be considered not ready for inspection. This can happen if you have recently replaced your battery or if your battery has run down. The diagnostic system is designed to evaluate critical emission control systems during normal driving. This may take several days of routine driving. If you have done this and your vehicle still does not pass the inspection for lack of OBD system readiness, your GM dealer can prepare the vehicle for inspection.

Engine Oil Pressure Gage

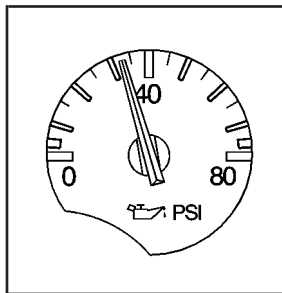

United States

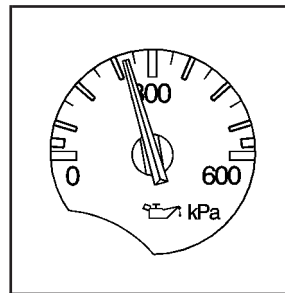

Canada

The engine oil pressure gage shows the engine oil pressure in psi (pounds per square inch) or kPa (kilopascals) when the engine is running.

Oil pressure should be 20 to 80 psi (140 to 550 kPa). In certain situations such as long, extended idles on hot days, it could read as low as 6 psi (40 kPa) and still be considered normal. It may vary with engine speed, outside temperature and oil viscosity, but readings above the shaded area show the normal operating range. Readings in the shaded area tell you that the engine is low on oil, or that you might have some other oil problem. See *Engine Oil* on page 5-13.

The engine oil pressure can also be displayed using the GAGES button on the Driver Information Center (DIC). See *Driver Information Center (DIC)* on page 3-48.

 **CAUTION:**

Do not keep driving if the oil pressure is low. If you do, your engine can become so hot that it catches fire. You or others could be burned. Check your oil as soon as possible and have your vehicle serviced.

Notice: Lack of proper engine oil maintenance may damage the engine. The repairs would not be covered by your warranty. Always follow the maintenance schedule in this manual for changing engine oil.

Security Light



This light comes on to remind you to arm your theft-deterrent system. If it comes on and stays on when your ignition is on, there may be a problem with your theft-deterrent system.

See *Theft-Deterrent System* on page 2-16 and *PASS-Key[®]* on page 2-18.

Check Gages Warning Light



This light will come on briefly when you are starting the engine. If the light comes on and stays on while you are driving, check your gages to see if they are in the warning areas.

This light can come on for the following reasons:

- Low Oil Pressure
- High Coolant Temperature
- High or Low Battery Voltage
- Low Fuel Level

Fuel Gage

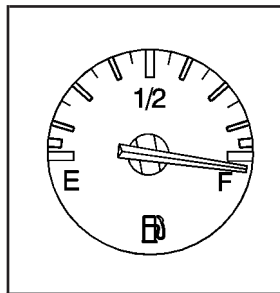

Your fuel gage tells you about how much fuel you have left when the ignition is on.

When the needle approaches the red zone, RESERVE FUEL will appear on the Driver Information Center (DIC) display. When the needle approaches the E, LOW FUEL will appear on the display. At this time, you still have a little fuel left, but you should get more soon.

Press RESET to acknowledge a DIC message(s). Pressing RESET will also turn off a DIC message but the LOW FUEL message will come on again in 10 minutes if you have not added fuel to the vehicle.

Here are five things that some owners ask about. All these things are normal and do not indicate that anything is wrong with the fuel gage.

- At the gas station, the gas pump shuts off before the gage reads F (full).
- It takes more (or less) fuel to fill up than the gage reads. For example, the gage reads half full, but it took more (or less) than half of the tank's capacity to fit it.
- The gage pointer may move while cornering, braking or speeding up.
- The gage may not indicate E (empty) when the ignition is turned off.
- The gage reading may change slightly within the first several minutes after starting the vehicle.

You can use the Driver Information Center (DIC) to display more detailed fuel information. Each time you press FUEL, one of the following will appear in the Driver Information Center (DIC).

- **AVERAGE:** The fuel economy calculated for the current tank of fuel, or since you last reset the display.
- **INST (Instant):** The fuel economy calculated for your current driving conditions.
- **RANGE:** The distance you can drive before refueling.

You should reset the fuel information display every time you refuel. To reset the display, press FUEL until AVERAGE appears. Then, press RESET on the Driver Information Center (DIC).

Driver Information Center (DIC)

The Driver Information Center (DIC) will display information about how your vehicle is functioning, as well as warning messages if a system problem is detected. The DIC display area is located in the instrument panel cluster below the speedometer and tachometer, directly above the steering column.

The following buttons are located on the DIC control panel which is located to the right of the instrument panel cluster.

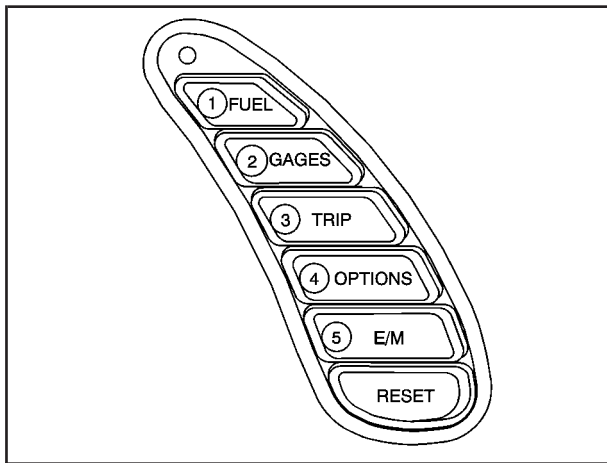

1 FUEL: Press this button to display fuel information such as fuel economy and range.

2 GAGES: Press this button to display gage information like oil pressure and temperature, coolant temperature, automatic transmission fluid temperature (if equipped), battery voltage and front/rear tire pressures.

3 TRIP: Press this button to display your total and trip miles, the elapsed time function, your average speed and the engine oil life.

4 OPTIONS: This button allows you to choose personal options that are available on your vehicle, depending on the options your vehicle is equipped with, such as security, door locks, easy entry seats and language.

5 E/M (English/Metric): Press this button to change the display between English and metric units.

RESET: This button, used along with the other buttons, will reset system functions and turn off or acknowledge messages on the Driver Information Center (DIC).

At the top of the DIC control buttons is a light sensor. Be sure not to block the sensor or your lighting functions may be disrupted.

DIC Controls and Displays

Turn on the system by turning the ignition to ON. When you turn on the ignition, the DIC will be in the mode last displayed when the engine was turned off. Each DIC button allows you to scroll through a menu. A blank page ends each menu.

If a problem is detected, a diagnostic message will appear on the display. Press RESET to acknowledge any current warning or service messages. The following pages will show the messages you can see on the Driver Information Center (DIC) display by pressing the DIC buttons.

1 FUEL

The FUEL button displays average fuel economy and instantaneous fuel economy calculated for your specific driving conditions and range.

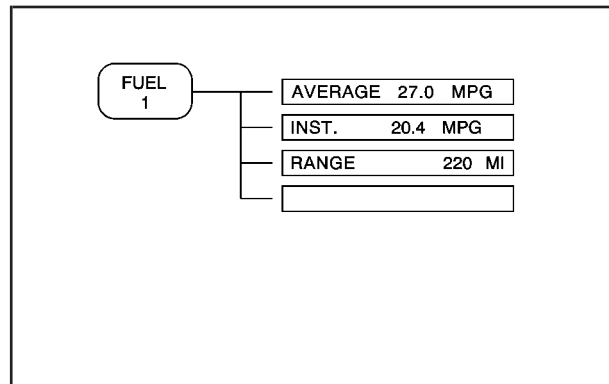

Press the FUEL button to display average fuel economy, such as:

- AVERAGE 20.1 MPG or
- AVERAGE 5.3 L/100 km

The average fuel economy is viewed as a long-term approximation of your overall driving conditions. If you press RESET in this mode while you're driving, the system will begin figuring fuel economy from that point in time.

Press FUEL again to display instantaneous fuel economy, such as:

- INST. 20.1 MPG or
- INST. 5.3 L/100 km

Press FUEL again to display the range, such as:

- RANGE 20 MI or
- RANGE 32 km

The range calculates the remaining distance you can drive without refueling. It's based on fuel economy and the fuel remaining in the tank.

If the range is lower than 30 miles (48 km), the display will read RANGE LOW.

The fuel economy data used to determine fuel range is an average of recent driving conditions. As your driving conditions change, this data is gradually updated. Resetting the fuel range causes the fuel economy data to be updated immediately. Press RESET to reset the fuel range.

2 GAGES

The GAGES button allows you to scroll through the functions listed below when you press it.

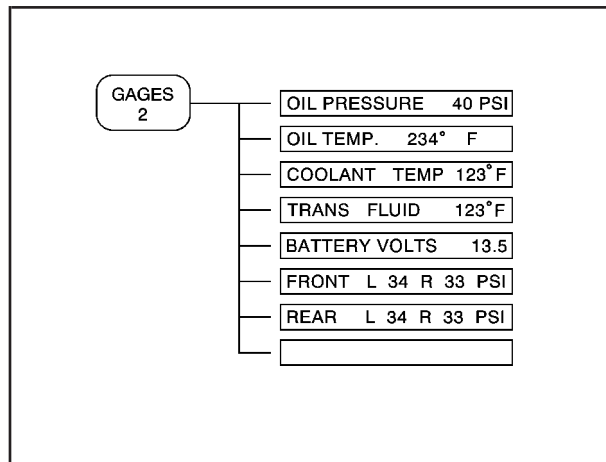

Press the GAGE button to display the oil pressure, such as:

- OIL PRESSURE 40 PSI or
- OIL PRESSURE 276 kPa

Press the GAGE button again to display the oil temperature, such as:

- OIL TEMP 234°F or
- OIL TEMP 112°C

Press the GAGE button again to display the coolant temperature, such as:

- COOLANT TEMP 123°F or
- COOLANT TEMP 51°C

Press the GAGE button again to display the automatic transmission fluid temperature (if equipped), such as:

- TRANS FLUID 123°F or
- TRANS FLUID 51°C

Press the GAGE button again to display the battery voltage, such as:

- BATTERY VOLTS 13.5

Press the GAGE button again to display the tire pressure for the front tires (except Z06), such as:

- FRONT L34 R33 PSI or
- FRONT L234 R228 kPa

Press the GAGE button again to display the tire pressure for the rear tires (except Z06), such as:

- REAR L34 R33 PSI or
- REAR L234 R228 kPa

Tire pressure is not available until the vehicle has reached a speed of 15 mph (24 km/h) or more.

3 TRIP

The TRIP button allows you to scroll through the functions listed below when you press it.

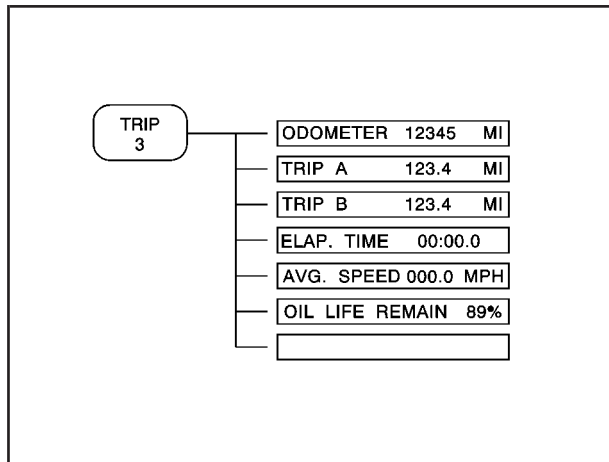

Odometer

The odometer shows how far your vehicle has been driven in either miles or kilometers. Press the TRIP button to display odometer readings such as:

- ODOMETER 12345 MI or
- ODOMETER 20008 km

Without the keys in the ignition, you can also display the odometer by turning on the parking lamps.

Trip Odometers

There are two trip odometers. Press the TRIP button and TRIP A will be displayed. Press it again and TRIP B will be displayed. TRIP A could be used to track the distance to a destination. TRIP B could be used to track maintenance periods.

1. TRIP A 130.5 MI or
2. TRIP A 209.9 km
3. TRIP B 300.5 MI or
4. TRIP B 483.5 km

The trip odometers can be reset by pressing the RESET button on the DIC. Both of the trip odometers can be used simultaneously.

Miles Since Last Ignition Feature

You can also display number of miles (kilometers) driven since you last started the vehicle if you press and hold the RESET button for two seconds, then release. The miles (or kilometers) since the last ignition cycle will be set into the trip odometer.

Elapsed Time

Press the TRIP button until ELAP. TIME is displayed, such as ELAP. TIME 00:00:00.00.

When the ignition is in ON, the Driver Information Center (DIC) can be used as a stopwatch. The display can show hours, minutes, seconds and hundredths of a second. The elapsed time indicator will record up to 99 hours, 59 minutes and 59 seconds, then it will reset to zero and continue counting. (Hundredths are shown up to 59 minutes, 59 seconds and 99 hundredths). The display appears as ELAP. TIME 00:00:00.00 in the elapsed time function.

You can start or stop the elapsed time by pressing RESET. To reset the elapsed time to zero, stop the timer by pressing RESET. Then press and hold RESET until ELAP. TIME 00:00:00.00 appears in the DIC.

Average Speed

Press the TRIP button until the average speed is displayed, such as:

- AVERAGE SPEED 62 MPH or
- AVERAGE SPEED 100 km/h

Press reset in this mode to start calculating the average speed. Press and hold RESET to clear.

Engine Oil Life

Press the TRIP button until the engine oil life is displayed, such as OIL LIFE REMAIN 89%.

This is an estimate of the engine oil's remaining useful life. It will show 100% when the system is reset after an oil change. It will alert you to change your oil on a schedule consistent with your driving conditions.

When the remaining oil life is low, the system will alert you with the message CHANGE OIL SOON.

When the oil life is down to zero, you will receive the message CHANGE OIL NOW.

Remember, you must reset the OIL LIFE yourself after each oil change. It will not reset itself. Also, be careful not to reset the OIL LIFE accidentally at any time other than when the oil has just been changed.

It can't be reset accurately until the next oil change.

To reset the system, see "How to Reset the Change Oil Soon Message" under *Engine Oil on page 5-13*.

Also, see *Engine Oil on page 5-13* and *Scheduled Maintenance on page 6-4*.

4 OPTIONS

This button allows you to choose personal options that may be available on your vehicle, depending on the options your vehicle is equipped with. Some of these functions work along with the remote keyless entry transmitter.

When returning to the options menu, the first item of the options list will always be displayed, not the one you were last in when you changed buttons.

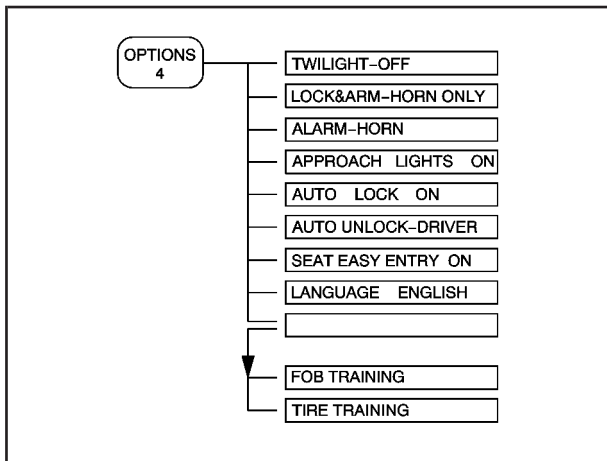

The following are the options listed under the OPTIONS button:

Twilight (Optional in United States, Standard in Canada)

Press the OPTIONS button until TWILIGHT-OFF appears on the display, then use the RESET button to page through the following selections:

- TWILIGHT – ON
- TWILIGHT – OFF

If you choose TWILIGHT – ON, press the OPTIONS button again to display DELAY TIME 1 2 in the DIC. Use the OPTIONS button to switch between delay time 1 and 2. You can increase the delay time by pressing button 1 (1 FUEL) or decrease the time by pressing button 2 (2 GAGES). Each bar is equal to 12 seconds.

Lock and Arm

Press the OPTIONS button until LOCK & ARM appears on the display, then use the RESET button to page through the following selections:

- LOCK & ARM – OFF
- LOCK & ARM – HORN ONLY
- LOCK & ARM – LIGHTS ONLY
- LOCK & ARM – HORN & LIGHTS

If you choose LOCK & ARM – OFF, you will receive no security feedback when locking or unlocking your vehicle.

If you choose LOCK & ARM – HORN ONLY, only the horn will chirp to let you know when your alarm system has armed when locking your vehicle.

If you choose LOCK & ARM – LIGHTS ONLY, only your exterior lamps will flash to let you know when your alarm system has armed when locking your vehicle.

If you choose LOCK & ARM – HORN & LIGHTS, the horn will chirp and the exterior lamps will flash briefly to let you know the system has armed when locking your vehicle.

Alarm

Press the OPTIONS button until ALARM appears on the display, then use the RESET button to page through the following selections:

- ALARM-HORN
- ALARM HORN & LIGHTS

If you choose ALARM-HORN, the horn will sound during an alarm.

If you choose ALARM HORN & LIGHTS, the horn will sound and the interior and exterior lamps will flash during an alarm.

Approach Lights

Press the OPTIONS button until APPROACH LIGHTS appears on the display, then use the RESET button to page through the following choices:

- APPROACH LIGHTS ON
- APPROACH LIGHTS OFF

If you choose APPROACH LIGHTS ON, the fog lamps, front turn signal, rear back-up and courtesy lamps will come on for 30 seconds when you press UNLOCK on the remote keyless entry transmitter. This will occur only when it is dark outside.

APPROACH LIGHTS OFF turns off this option.

See *Remote Keyless Entry System on page 2-5* for more information.

Auto Lock

Press the OPTIONS button until AUTO LOCK appears on the display, then use the RESET button to page through the following choices:

- AUTO LOCK ON
- AUTO LOCK OFF

If you choose AUTO LOCK ON, both doors will automatically lock when the vehicle exceeds 10 mph (16 km/h) in a manual transmission. In a vehicle with an automatic transmission, both doors will automatically lock when you move the shift lever out of PARK (P).

Choose AUTO LOCK OFF to turn this option off.

Auto Unlock

The AUTO UNLOCK will be available only if AUTO LOCK is set to ON as described previously.

Press the OPTIONS button until AUTO UNLOCK appears on the display, then use the RESET button to page through the following choices:

- AUTO UNLOCK DRIVER
- AUTO UNLOCK BOTH
- AUTO UNLOCK OFF

If you choose AUTO UNLOCK DRIVER, the driver's door will automatically unlock when you turn the vehicle off and pull the key out of the ignition.

Choose AUTO UNLOCK BOTH, and both doors will automatically unlock when you turn the vehicle off and pull the key out of the ignition.

AUTO UNLOCK OFF turns off this option.

Easy Entry

The easy entry feature will only be available if the vehicle is equipped with the memory option.

Press the OPTIONS button until SEAT EASY ENTRY appears on the display, then use the RESET button to page through the following choices:

- SEAT EASY ENTRY ON
- SEAT EASY ENTRY OFF

If you choose SEAT EASY ENTRY ON, when you turn the ignition off and remove the key, the seat will automatically move back and the telescopic steering wheel (if equipped) will return to its full-forward position for an easy exit or an easy entrance when returning to the vehicle.

The seat will only return to the forward position if you unlock the door with the keyless entry transmitter or press the appropriate MEMORY button.

SEAT EASY ENTRY OFF turns off this option.

Languages

You can select which language the DIC will display its messages. Press the OPTIONS button until the word LANGUAGES appears on the display, then use the RESET button to page through the following choices:

- LANGUAGE ENGLISH
- LANGUAGE FRENCH
- LANGUAGE GERMAN
- LANGUAGE SPANISH

Blank Page

There is a blank page at the end of the OPTIONS menu. When the blank page is displayed, you can access the following items:

FOB TRAINING: This option allows you to match the RKE transmitter(s) to your vehicle. You can access this option by pressing and holding RESET for three seconds while you are on the blank page at the end of the OPTIONS menu. The message FOB TRAINING will be displayed. See “Matching Transmitter(s) To Your Vehicle” under *Remote Keyless Entry System Operation on page 2-6*.

TIRE TRAINING (Except Z06): The Tire Pressure Monitor (TPM) operates with battery-powered sensors that are located inside the valve stems on each tire. Each sensor has a unique ID code so the vehicle knows the tire location of the sensor. When the vehicle reaches a speed of greater than 15 mph (24 km/h), the sensors begin to send the tire pressure readings to a receiver inside the vehicle. These readings are displayed when using the GAGES button on the DIC. If you are unable to display your tire pressures while the vehicle speed is greater than 15 mph (24 km/h), you may need to have your sensor ID codes learned by the vehicle. See your dealer.

DIC Warnings and Messages

The following messages and warnings may appear in the DIC display. The DIC display area is located in the instrument panel cluster below the speedometer and tachometer, directly above the steering column. You may receive more than one message at a time. Messages will appear one behind the other. To acknowledge a message and remove it from the display, press RESET. You may scroll through the messages that may have been sent at the same time. The message center is continuously updated with the vehicle performance status.

ABS ACTIVE (Anti-Lock Brake System Active):

When your anti-lock system is adjusting brake pressure to help avoid a braking skid, the ABS ACTIVE message will be displayed.

Slippery road conditions may exist if this message is displayed, so adjust your driving accordingly. The message will stay on for a few seconds after the system stops adjusting brake pressure.

ACT HNDLG – WARMING UP: When you first start your vehicle (especially during cold winter weather), and begin to drive away (up to 6 mph (10 km/h)), the message ACT HNDLG – WARMING UP may be displayed in the DIC, the instrument panel cluster light will be on, and a chime will sound. This is normal. You can acknowledge this message by pressing the RESET button. The Active Handling System performance is affected until the next message WARM UP COMPLETE is displayed in the DIC.

During hot or cold temperature conditions, this message may be displayed in the DIC after exceeding 12 mph (20 km/h) for 30 seconds. The Active Handling System is off until the WARM UP COMPLETE message is displayed.

ACTIVE HANDLING: Your vehicle is equipped with a computer controlled system to assist the driver in controlling the vehicle in difficult driving conditions. You may feel or hear the system working and see the ACTIVE HANDLING message displayed in the DIC. This is normal when the system is operating. Also see *Braking on page 4-6*.

CHARGE SYSTEM FAULT: Press RESET to acknowledge that you have read the message and to remove it from the display. The message will reappear every 10 minutes until this condition changes. You will hear two chimes when this message is displayed.

If this message comes on while you are driving, you may have a problem with the electrical charging system. It could indicate that you have a loose or broken drive belt or another electrical problem. Have it checked right away. Driving while this light is on could drain your battery.

If you must drive a short distance with the message on, be certain to turn off your accessories, such as the radio and air conditioner.

COMPETITIVE DRIVING: When the Competitive Driving mode is selected, this message will be displayed in the DIC. The instrument panel cluster light will not be on when the Competitive Driving mode is selected. The Traction Control System will not be operating while in the Competitive Driving mode. You should adjust your driving accordingly.

COOLANT OVER TEMP: You will hear four chimes and the CHECK GAGES telltale will come on when this message is displayed. To acknowledge the warning, press the RESET button. After you press the RESET button, a message will be displayed and you will hear a chime every minute until this condition changes. If you do not press RESET, the message will remain on the digital display until the condition changes.

If the engine coolant exceeds 255°F (124°C), this message is displayed. If you have been operating your vehicle under normal driving conditions, you should pull off the road, stop your vehicle and turn off the engine as soon as possible. You can monitor the coolant temperature with the GAGES button on the DIC or the engine coolant gage on the instrument panel cluster. See *Engine Overheating* on page 5-26.

FLAT TIRE (Except Z06): You will hear two chimes when this message is displayed followed by the message MAX SPEED 55 MPH (90 km/h). If this message appears, do not drive your vehicle above this limit. The next message to appear is REDUCED HANDLING. Adjust your driving accordingly. To acknowledge these warnings, press RESET. After you press RESET, a message will reappear every 10 minutes until this condition changes. This message indicates that the pressure in one of your tires is lower than 5 psi (34 kPa). Next to the FLAT TIRE message, you can see either LF (left front), LR (left rear), RF (right front) or RR (right rear) to indicate to you which tire is flat. You can receive more than one tire pressure message at a time. To read other messages that may have been sent at the same time, press RESET. If a tire pressure message appears on the DIC, stop as soon as you can. Have the tire pressures checked and set to those shown on your Tire Loading Information Label. See *Extended Mobility Tires (Except Z06)* on page 5-61 and *Inflation - Tire Pressure* on page 5-62.

 **CAUTION:**

When the LOW TIRE PRESSURE or FLAT TIRE message is displayed on the Driver Information Center, your vehicle's handling capabilities will be reduced during severe maneuvers. If you drive too fast, you could lose control of your vehicle. You or others could be injured. Don't drive over 55 mph (90 km/h) when the LOW TIRE PRESSURE or FLAT TIRE message is displayed. Drive cautiously and check your tire pressures as soon as you can.

HIGH TIRE PRESSURE – (LF, LR, RF, RR)

(Except Z06): You will hear two chimes when this message is displayed. To acknowledge the warning, press RESET. After you press RESET, a message will reappear every 10 minutes until this condition changes. This message indicates that the pressure in one of your tires is higher than 42 psi (290 kPa). Next to the HIGH TIRE PRESSURE message, you can see either LF (left front), LR (left rear), RF (right front) or RR (right rear) to indicate to you which tire is higher than 42 psi (290 kPa). You can receive more than one tire pressure message at a time. To read other messages that may have been sent at the same time, press RESET. If a tire pressure message appears on the DIC, stop as soon as you can. Have the tire pressures checked and set to those shown on your Tire Loading Information Label. See *Extended Mobility Tires (Except Z06)* on page 5-61 and *Inflation - Tire Pressure* on page 5-62.

HIGH TRANS TEMP (Automatic Transmission Only):

You will hear four chimes when this message is displayed. To acknowledge this warning, press the RESET button. After you press the RESET button, the message will be displayed every 10 minutes until the condition changes. If you do not press RESET, the message remains on the display until the condition changes.

If the transmission fluid temperature rises above 270°F (132°C) or rises rapidly, this message is displayed. The transmission may shift gears or apply the torque converter clutch to reduce the fluid temperature. Driving aggressively or driving on long hills can cause the transmission fluid temperature to be higher than normal. If this message appears, you may continue to drive at a slower speed. You should also monitor the transmission fluid temperature and allow it to cool to at least 230°F (110°C). The transmission fluid temperature can be monitored with the GAGES button on the DIC. See *Automatic Transmission Fluid* on page 5-20. You should also check the engine coolant temperature. If it is also hot, see *Engine Overheating* on page 5-26.

If the HIGH TRANS TEMP message is displayed during normal vehicle operation on flat roads, your vehicle may need service. See your dealer for an inspection.

LOW OIL LEVEL: Press RESET to acknowledge that you have read the message and to remove it from the display. The message will reappear every 10 minutes until this condition changes. Once the vehicle senses a temperature change in the engine oil, the light will remain off.

You will hear two chimes when this message is displayed. If this message appears after starting your engine, your engine oil level may be too low. You may need to add oil. See *Engine Overheating on page 5-26*.

LOW OIL PRESSURE: You will hear four chimes and the CHECK GAGES telltale will come on when this message is displayed. To acknowledge the warning, press the RESET button. After you press the RESET button, a message will be displayed and you will hear a chime every minute until the vehicle is serviced. If you do not press RESET, the message will remain on the digital display until the vehicle is serviced.

Low oil pressure may be the result of a combination of low oil level and abrupt changes in the vehicle's direction. When this warning is displayed, you should not operate the engine at high rpm or make fast abrupt moves. As soon as possible, you should check the oil level. See *Engine Oil on page 5-13*.

LOW TIRE PRESSURE (Except Z06): You will hear two chimes when this message is displayed. To acknowledge the warning, press RESET. After you press RESET, a message will appear every 10 minutes until this condition changes. This message indicates that the pressure in one of your tires is less than 25 psi (172 kPa). Next to the LOW TIRE PRESSURE message, you can see either LF (left front), LR (left rear), RF (right front) or RR (right rear) to indicate to you which tire is low on pressure. You can receive more than one tire pressure message at a time. To read other messages that may have been sent at the same time, press RESET. If a tire pressure message appears on the DIC, stop as soon as you can. Have the tire pressures checked and set to those shown on your Tire Loading Information Label. See *Extended Mobility Tires (Except Z06) on page 5-61* and *Tire Pressure Monitor Operation (Except Z06) on page 5-64*.

 **CAUTION:**

When the LOW TIRE PRESSURE or FLAT TIRE message is displayed on the Driver Information Center, your vehicle's handling capabilities will be reduced during severe maneuvers. If you drive too fast, you could lose control of your vehicle. You or others could be injured. Don't drive over 55 mph (90 km/h) when the LOW TIRE PRESSURE or FLAT TIRE message is displayed. Drive cautiously and check your tire pressures as soon as you can.

MAXIMUM SPEED 80 MPH (129 km/h): You will hear four chimes when this message is displayed. To acknowledge the warning, press RESET. After you press RESET, a message will reappear every 10 minutes until this condition changes.

This message indicates that a malfunction is present in the selective real time damping system. The vehicle speed will be limited to 80 mph (129 km/h) when the shock absorber system has failed and the shocks are in their full soft mode. Have your vehicle serviced as soon as possible.

PULL KEY – WAIT 10 SEC (Manual Transmission Only): If this message comes on, the steering column lock system has detected a problem while disengaging the steering column lock. This message may occur when the ignition key is removed and reinserted before the steering column lock system fully locks or unlocks the steering column. To acknowledge that you have read this message, and to clear it from the display, remove the ignition key and wait 10 seconds before reinserting the key into the ignition. If you attempt to operate your vehicle without removing the key for 10 seconds, the vehicle's fuel system will shut off when you reach 1.5 mph (2.4 km/h). If the message stays on after removing the key and waiting 10 seconds, have your vehicle taken to an authorized dealer as soon as possible for diagnosis and repair.

REDUCED ENGINE POWER: You will hear chimes continuously when this message is displayed. To acknowledge that you have read the message and to remove it from the display, press RESET. The message will reappear every 15 seconds until this condition changes.

If the Driver Information Center (DIC) displays the REDUCED ENGINE POWER message and the CHECK ENGINE light comes on, a noticeable reduction in the vehicle's performance may occur. If the REDUCED ENGINE POWER message is displayed but there is no reduction in performance, proceed to your destination. The performance may be reduced the next time the vehicle is driven.

The vehicle may be driven at a reduced speed while the REDUCED ENGINE POWER message is displayed, but acceleration and speed may be reduced. Anytime the CHECK ENGINE light stays on, the vehicle should be taken to an authorized dealer as soon as possible for diagnosis and repair.

Also, refer to *Malfunction Indicator Lamp on page 3-41*. If the REDUCED ENGINE POWER message is displayed in combination with the COOLANT OVER TEMP message, see *Engine Overheating on page 5-26*.

REDUCE ENGINE RPM: You will hear four chimes when this message is displayed. To acknowledge the warning, press the RESET button. After you press the RESET button, a message will be displayed and you will hear a chime every minute until this condition changes. If you do not press RESET, the message will remain on the digital display until the condition changes.

If the engine oil temperature exceeds 320°F (160°C), this message is displayed. You should check the engine coolant temperature and engine oil level. If your engine is too hot, see *Engine Overheating on page 5-26*. Your vehicle may need service, so see your dealer. You can monitor the oil temperature with the GAGES button on the DIC.

SERVICE ABS (Anti-Lock Brake System): If the SERVICE ABS message is displayed when you are driving, stop as soon as possible and turn the ignition off. Then start the engine again to reset the system. If the message stays on, or comes back on again while you are driving, your vehicle is in need of service. If the regular brake system warning light is not on, you still have brakes, but do not have anti-lock brakes. If the regular brake system light is also on, you do not have anti-lock brakes and there is a problem with your brakes. See *Brake System Warning Light on page 3-38*.

If the SERVICE ABS message is being displayed, your Traction Control System and the Active Handling System will also be disabled. The Driver Information Center will scroll three messages: SERVICE ABS, SERVICE TRACTION SYS and SERVICE ACTIVE HNDLG, and the instrument cluster car icon will be illuminated. The driver can acknowledge these messages by pressing the reset button three times. When the service message is displayed the computer controlled systems will not assist the driver and you should have the system repaired as soon as possible. Adjust your driving accordingly.

SERVICE ACTIVE HANDLING: If the SERVICE ACTIVE HNDLG message is displayed, there is a problem with your Active Handling System and your vehicle needs service. The instrument cluster light will also be on and a chime will sound. When this message is displayed, the system is not working. Adjust your driving accordingly.

SERVICE COLUMN LOCK (Manual Transmission Only): If the system that controls the locking and unlocking of the steering column does not work properly, have the vehicle towed to a dealer for service.

SERVICE RIDE CONTROL: This message is used to indicate to the driver that the Selective Ride Control system has detected a malfunction and that the system must be serviced. The SERVICE RIDE CONTROL message will always come on when a failure is detected by the Selective Ride Control system. If a fault is present in the Selective Ride Control system which causes the shocks to be in their full soft condition, the SERVICE RIDE CONTROL, SHOCKS INOPERATIVE and MAXIMUM SPEED 80 MPH (129 km/h) will display together. You will never get a SHOCKS INOPERATIVE and MAXIMUM SPEED 80 MPH (129 km/h) message without a SERVICE RIDE CONTROL message.

SERVICE TIRE MON SYS (Except Z06): If this message comes on, a part on the Tire Pressure Monitor (TPM) is not working properly. If you drive your vehicle while any of the four sensors are missing or inoperable, the warning will come on in about 10 minutes. If all four sensors are missing, the warning will come on in about 15 to 20 minutes. All the sensors would be missing, for example, if you put different wheels on your vehicle without transferring the sensors. If the warning comes on and stays on, there may be a problem with the TPM. See your dealer.

SERVICE TRACTION SYSTEM: If the SERVICE TRACTION SYS message is displayed when you are driving, there is a problem with your Traction Control System and your vehicle is in need of service. When this message is displayed, the system will not limit wheel spin. Adjust your driving accordingly.

The SERVICE ACTIVE HNDLG message will also be displayed and the instrument cluster car icon will also be illuminated. The driver can acknowledge both messages by pressing the reset button two times which will also

turn off the instrument cluster icon. When the service messages are displayed, the computer controlled systems will not assist the driver in controlling the vehicle. Have the system repaired as soon as possible. Adjust your driving accordingly.

SERVICE VEHICLE SOON: If this message appears on the DIC, there may be an electrical or another system problem with your vehicle. Have your vehicle checked by your dealer if this message keeps appearing.

SHOCKS INOPERATIVE: You will hear four chimes when this message is displayed. To acknowledge that you have read the message and to remove it from the display, press RESET. The message will reappear every 10 minutes until this condition changes.

This message indicates that a malfunction is present in the Selective Ride Control system which is causing the shocks to be in their full soft mode. This is a warning to the driver that the vehicle handling may be affected. Have your vehicle serviced as soon as possible.

TRAC/ACT HNDLG – OFF: By pressing the Active Handling System console button briefly, the driver can turn the Traction Control and Active Handling Systems off. The message TRAC/ACT HNDLG – OFF will be displayed in the DIC, the instrument panel cluster light will be on and a chime will sound. You can acknowledge this message by pressing the RESET button. The anti-lock brake systems remains on with the Traction Control and Active Handling Systems off. You should adjust your driving accordingly.

TRAC/ACT HNDLG – ON: If the Traction Control and Active Handling Systems are off, pressing the Active Handling System console button momentarily will turn both systems on. The message TRAC/ACT HNDLG – ON will be displayed temporarily in the DIC, the instrument panel cluster light will be off and a chime will sound.

TRACTION SYS ACTIVE: When your Traction Control System is limiting wheel spin, the TRACTION SYS ACTIVE message will be displayed. Slippery road conditions may exist if this message is displayed, so adjust your driving accordingly. The message will stay on for a few seconds after the Traction Control System stops limiting wheel spin.

TRACTION SYSTEM – OFF: You will hear a single quick tone when this message is displayed. This message comes on and stays on when the Traction Control System button on the console is pressed to turn the system off. To acknowledge this message, press RESET.

TRACTION SYSTEM – ON: This message is displayed when you decide to turn on the Traction Control System by pressing the switch on the console. This message will shut off automatically on its own.

WARM UP COMPLETE: If you receive this message and hear a chime, the system has completed the functional check of the Active Handling System.

Other Messages

Here are more messages that you can receive on your Driver Information Center (DIC). To acknowledge a message and read another message that may have come on at the same time, press the RESET button.

- BRAKE BEFORE SHIFT
(See “Automatic Transmissions Only” under *Automatic Transmission Operation on page 2-25.*)
- CHANGE OIL NOW
(See “GM Oil Life System™” under *Engine Oil on page 5-13.*)
- CHANGE OIL SOON
(See “GM Oil Life System™” under *Engine Oil on page 5-13.*)
- CRUISE DISENGAGED
(See “Cruise Control” under *Turn Signal/Multifunction Lever on page 3-6.*)
- CRUISE SET_MPH (_km/h)
(See “Cruise Control” under *Turn Signal/Multifunction Lever on page 3-6.*)
- DOOR AJAR
- ENGINE PROTECTION REDUCE ENGINE RPM
- HATCH AJAR (Coupe)
- HIGH VOLTAGE
(See *Voltmeter Gage on page 3-37.*)
- LOW BRAKE FLUID
(See “Brake Fluid” under *Brakes on page 5-37.*)
- LOW FUEL
(See *Fuel Gage on page 3-46.*)
- LOW VOLTAGE
(See *Voltmeter Gage on page 3-37.*)
- LOW WASHER FLUID
(See *Windshield Washer Fluid on page 5-36.*)
- RESERVE FUEL
(See *Fuel Gage on page 3-46.*)
- TONNEAU AJAR (Convertible)
- TRUNK AJAR (Convertible/Z06)
- UPSHIFT NOW
(See *Manual Transmission Operation on page 2-28.*)

Audio System(s)

Notice: Before you add any sound equipment to your vehicle – like a tape player, CB radio, mobile telephone or two-way radio – be sure you can add what you want. If you can, it's very important to do it properly. Added sound equipment may interfere with the operation of your vehicle's engine, radio or other systems, and even damage them. Your vehicle's systems may interfere with the operation of sound equipment that has been added improperly.

So, before adding sound equipment, check with your dealer and be sure to check federal rules covering mobile radio and telephone units.

Your audio system has been designed to operate easily and to give years of listening pleasure. You will get the most enjoyment out of it if you acquaint yourself with it first. Figure out which radio you have in your vehicle, find out what your audio system can do and how to operate all of its controls to be sure you're getting the most out of the advanced engineering that went into it.

Your vehicle may have a feature called Retained Accessory Power (RAP). With RAP, you can play your audio system even after the ignition is turned off. See "Retained Accessory Power (RAP)" under *Ignition Positions on page 2-20*.

Setting the Time

Press and hold HR until the correct hour appears on the display. Press and hold MN until the correct minute appears on the display.

Radio with Cassette



Your vehicle is equipped with six Bose® amplified speakers. See your dealer for details.

Playing the Radio

PWR (Power): Press this knob to turn the system on and off.

VOL (Volume): Turn this knob to increase or to decrease volume.

RECALL: Press this button to switch the display between the radio station frequency and the time. Time display is available with the ignition turned off.

SCV (Speed-Compensated Volume): With SCV, your audio system adjusts automatically to make up for road and wind noise as you drive.

Set the volume at the desired level. Turn the control ring behind the power knob clockwise to increase the SCV. Each notch on the control ring allows for more volume compensation at faster vehicle speeds. Then, as you drive, SCV automatically increases the volume, as necessary, to overcome noise at any speed. The volume level should always sound the same to you as you drive. If you do not want to use SCV, turn the control all the way down.

Finding a Station

AM FM: Press this button to switch between FM1, FM2, and AM. The display will show your selection.

TUNE: Press this knob lightly so it extends. Turn it to select radio stations. Push the knob back into its stored position when you are not using it.

◀ SEEK ▶: Press the right or the left arrow to go to the next or to the previous station and stay there.

To scan stations, press either SEEK arrow for two seconds. SCAN will appear on the display. The radio will go to a station, play for a few seconds, then go on to the next station. Press either SEEK arrow again to stop scanning.

The radio will seek or scan only to stations that are in the selected band and only to those with a strong signal.

P.SCAN (Preset Scan): Press this button to scan your preset stations. P.SCAN will appear on the display. The radio will go to the first preset station stored on your pushbuttons, play for a few seconds, then go on to the next preset station. Press P.SCAN again or one of the pushbuttons to stop scanning presets.

The radio will scan only to preset stations that are in the selected band and only to those with a strong signal.

Setting Preset Stations

The six numbered pushbuttons let you return to your favorite stations. You can set up to 18 stations (six FM1, six FM2, and six AM) by performing the following steps:

1. Turn the radio on.
2. Press AM FM to select FM1, FM2, or AM.
3. Tune in the desired station.
4. Press AUTO TONE to select the equalization.
5. Press and hold one of the six numbered pushbuttons. The sound will mute. When the sound returns, release the pushbutton. Whenever you press that numbered pushbutton, the station you set will return and the equalization that you selected will be automatically stored for that pushbutton.
6. Repeat the steps for each pushbutton.

Setting the Tone (Bass/Treble)

BASS: To adjust the bass, press this knob lightly so it extends. Turn the knob to increase or to decrease bass.

TREB (Treble): To adjust the treble, press this knob lightly so it extends. Turn the knob to increase or to decrease treble. If a station is weak or noisy, you may want to decrease the treble.

Return these knobs to their stored positions when you are not using them.

AUTO TONE (Automatic Tone): Press this button to select customized equalization settings designed for country/western, jazz, talk, pop, rock, and classical.

To return the bass and treble to the manual mode, either press and release the AUTO TONE button until the display goes blank or press and release the BASS or TREB knob and turn it until the display goes blank.

Adjusting the Speakers (Balance/Fade)

BAL (Balance): To adjust the balance between the right and the left speakers, press this knob lightly so it extends. Turn the knob to move the sound toward the right or the left speakers.

FADE: To adjust the fade between the front and the rear speakers, press this knob lightly so it extends. Turn the knob to move the sound toward the front or the rear speakers.

Return these knobs to their stored positions when you are not using them.

Playing a Cassette Tape

Your tape player is built to work best with tapes that are up to 30 to 45 minutes long on each side. Tapes longer than that are so thin they may not work well in this player. The longer side of the tape visible should face to the right. If the ignition is on, but the radio is off, the tape can be inserted and will begin playing. A tape symbol will appear on the display whenever a tape is inserted. If you hear nothing or hear a garbled sound, it may not be inserted squarely. Press EJECT to remove the tape and start over.

While the tape is playing, use the VOL, AUTO TONE, BAL, FADE, BASS, and TREB controls just as you do for the radio. Other controls may have different functions when a tape is inserted. The display will show the tape symbol and an arrow to show which side of the tape is playing.

Your tape bias is set automatically when a metal or chrome tape is inserted. If you want to insert a tape when the ignition is off, first press the EJECT or RECALL button.

If an error appears on the display, see "Cassette Tape Messages" later in this section.

1 PREV (Previous): Your tape must have at least three seconds of silence between each selection for previous to work. Press this pushbutton to go to the previous selection on the tape if the current selection has been playing for less than eight seconds. If pressed when the current selection has been playing for more than eight seconds, it will go to the beginning of the current selection. If you hold this pushbutton or press it more than once, the player will continue moving backward through the tape.

2 PROG (Program): Press this pushbutton to play the other side of the tape.



3 NEXT: Your tape must have at least three seconds of silence between each selection for next to work. Press this pushbutton to go to the next selection on the tape. If you hold this pushbutton or press it more than once, the player will continue moving forward through the tape.

4 REV (Reverse): Press this pushbutton to reverse the tape rapidly. Press it again to return to playing speed. The radio will play while the tape reverses.

 **5 (Dolby®):** Press this pushbutton to reduce background noise. The double-D symbol will appear on the display.

Dolby® Noise Reduction is manufactured under a license from Dolby® Laboratories Licensing Corporation. Dolby® and the double-D symbol are trademarks of Dolby® Laboratories Licensing Corporation.

FWD 6 (Forward): Press this pushbutton to advance the tape rapidly. Press it again to return to playing speed. The radio will play while the tape advances.

 **SEEK**  : Your tape must have at least three seconds of silence between each selection for seek to work. Press the right or the left arrow to go to the next or to the previous selection on the tape.

AM FM: Press this button to listen to the radio when a cassette tape is playing. The inactive tape will remain safely inside the radio for future listening.

TAPE AUX (Auxiliary): Press this button to play a cassette tape when listening to the radio. The tape symbol with an arrow will appear on the display. If your system is equipped with a remote playback device, pressing this button a second time will allow the remote device to play.

EJECT: Press this button to remove the tape. EJECT may be used with the ignition or radio off. Cassettes may be loaded with the radio off if this button is pressed first. If you leave a cassette tape in the player while listening to the radio, it may become warm.

Cassette Tape Messages

The cassette tape player is able to detect a tight or broken tape, and will eject the tape. The radio will go back to playing the last station selected. Try a known good cassette tape.

CLN (Clean): If this message appears on the display, the cassette tape player needs to be cleaned. It will still play tapes, but you should clean it as soon as possible to prevent damage to the tapes and player. See *Care of Your Cassette Tape Player* on page 3-88.

If any error occurs repeatedly or if an error cannot be corrected, contact your dealer. If your radio displays an error message, write it down and provide it to your dealer when reporting the problem.

CD Adapter Kits

It is possible to use a portable CD player with your cassette tape player after activating the bypass feature on your tape player.

To activate the bypass feature, use the following steps:

1. Turn the ignition on.
2. Turn the radio off.
3. Press and hold the TAPE AUX button for five seconds. The tape symbol on the display will flash for two seconds, indicating the feature is active.
4. Insert the adapter into the cassette slot. It will power up the radio and begin playing.

The override feature will remain active until EJECT is pressed.

Radio with CD



Your vehicle is equipped with six Bose® amplified speakers. See your dealer for details.

Playing the Radio

PWR (Power): Press this knob to turn the system on and off.

VOL (Volume): Turn this knob to increase or to decrease volume.

RECALL: Press this button to switch the display between the radio station frequency and the time. Time display is available with the ignition turned off.

SCV (Speed-Compensated Volume): With SCV, your audio system adjusts automatically to make up for road and wind noise as you drive.

Set the volume at the desired level. Turn the control ring behind the power knob clockwise to increase the SCV. Each notch on the control ring allows for more volume compensation at faster vehicle speeds. Then, as you drive, SCV automatically increases the volume, as necessary, to overcome noise at any speed. The volume level should always sound the same to you as you drive. If you do not want to use SCV, turn the control all the way down.

Finding a Station

AM FM: Press this button to switch between FM1, FM2, and AM. The display will show your selection.

TUNE: Press this knob lightly so it extends. Turn it to select radio stations. Push the knob back into its stored position when you are not using it.

◀ SEEK ▶ : Press the right or the left arrow to go to the next or to the previous station and stay there.

To scan stations, press either SEEK arrow for two seconds. SCAN will appear on the display. The radio will go to a station, play for a few seconds, then go on to the next station. Press either SEEK arrow again to stop scanning.

The radio will seek or scan only to stations that are in the selected band and only to those with a strong signal.

P.SCAN (Preset Scan): Press this button to scan your preset stations. P.SCAN will appear on the display. The radio will go to the first preset station stored on your pushbuttons, play for a few seconds, then go on to the next preset station. Press P.SCAN again or one of the pushbuttons to stop scanning presets.

The radio will scan only to preset stations that are in the selected band and only to those with a strong signal.

Setting Preset Stations

The six numbered pushbuttons let you return to your favorite stations. You can set up to 18 stations (six FM1, six FM2, and six AM) by performing the following steps:

1. Turn the radio on.
2. Press AM FM to select FM1, FM2, or AM.
3. Tune in the desired station.
4. Press AUTO TONE to select the equalization.
5. Press and hold one of the six numbered pushbuttons. The sound will mute. When the sound returns, release the pushbutton. Whenever you press that numbered pushbutton, the station you set will return and the equalization that you selected will be automatically stored for that pushbutton.
6. Repeat the steps for each pushbutton.

Setting the Tone (Bass/Treble)

BASS: To adjust the bass, press this knob lightly so it extends. Turn the knob to increase or to decrease bass.

TREB (Treble): To adjust the treble, press this knob lightly so it extends. Turn the knob to increase or to decrease treble. If a station is weak or noisy, you may want to decrease the treble.

Return these knobs to their stored positions when you are not using them.

AUTO TONE (Automatic Tone): Press this button to select customized equalization settings designed for country/western, jazz, talk, pop, rock, and classical.

To return the bass and treble to the manual mode, either press and release the AUTO TONE button until the display goes blank or press and release the BASS or TREB knob and turn it until the display goes blank.

Adjusting the Speakers (Balance/Fade)

BAL (Balance): To adjust the balance between the right and the left speakers, press this knob lightly so it extends. Turn the knob to move the sound toward the right or the left speakers.

FADE: To adjust the fade between the front and the rear speakers, press this knob lightly so it extends. Turn the knob to move the sound toward the front or the rear speakers.

Return these knobs to their stored positions when you are not using them.

Playing a CD

Insert a CD partway into the slot, label side up. The player will pull it in. The CD should begin playing. CD and the CD symbol will appear on the display. If you want to insert a CD with the ignition off, first press the EJECT or the RECALL button.

If you turn off the ignition or radio with a CD in the player, it will stay in the player. When you turn on the ignition or radio, the CD will start playing where it stopped, if it was the last selected audio source.

As each new track starts to play the track number will appear on the display.

The CD player can play the smaller 8 cm single CDs with an adapter ring. Full-size CDs and the smaller CDs are loaded in the same manner.

If playing a CD-R the sound quality may be reduced due to CD-R quality, the method of recording, the quality of the music that has been recorded, and the way the CD-R has been handled. You may experience an increase in skipping, difficulty in finding tracks, and/or difficulty in loading and ejecting. If these problems occur try a known good CD.

Do not add paper labels to CDs, they could get caught in the CD player.

Do not play 3 inch CDs without a standard adapter CD.

If an error appears on the display, see "CD Messages" later in this section.

1 PREV (Previous): Press this pushbutton to go to the start of the current track if it has been playing for more than eight seconds. If you hold this pushbutton or press it more than once, the player will continue moving backward through the CD.

2 RDM (Random): Press this pushbutton to hear the tracks in random, rather than sequential, order. RANDOM will appear on the display. Press this pushbutton again to turn off random play.

3 NEXT: Press this pushbutton to go to the next track. If you hold this pushbutton or press it more than once, the player will continue moving forward through the CD.

REV 4 (Reverse): Press and hold this pushbutton to quickly reverse within a track. Release it to play the passage. The elapsed time of the track will appear on the display.

FWD 6 (Forward): Press and hold this pushbutton to quickly advance within a track. Release it to play the passage. The elapsed time of the track will appear on the display.

◀ **SEEK** ▶ : Press the left arrow to go to the start of the current or to the previous track. Press the right arrow to go to the start of the next track. If you hold either arrow or press it more than once, the player will continue moving backward or forward through the CD.

RECALL: Press this button to see which track is playing. Press it again within five seconds to see how long it has been playing (elapsed time).

AM FM: Press this button to listen to the radio when a CD is playing. The inactive CD will remain safely inside the radio for future listening.

CD AUX (Auxiliary): Press this button to play a CD when listening to the radio. CD will appear on the display when a CD is in the player. If your system is equipped with a remote playback device, pressing this button a second time will allow the remote device to play.

EJECT: Press this button to eject the CD. The radio will play. EJECT may be activated with the ignition or radio off. CDs may be loaded with the radio off if this button is pressed first. If you leave the CD in the player while listening to the radio, it may become warm.

CD Messages

ERR (Error): If this message appears on the display, and/or the CD comes out, it could be for one of the following reasons:

- It is very hot. When the temperature returns to normal, the CD should play.
- You are driving on a very rough road. When the road becomes smooth, the CD should play.
- The CD is dirty, scratched, wet, or upside down.
- It is very humid. If so, wait about an hour and try again.
- There may have been a problem while burning the CD.
- The label may be caught in the CD player.

Press RECALL to make ERR go off of the display.

If the CD is not playing correctly, for any other reason, try a known good CD.

If any error occurs repeatedly or if an error cannot be corrected, contact your dealer. If your radio displays an error message, write it down and provide it to your dealer when reporting the problem.

Trunk-Mounted CD Changer

If your vehicle has the optional trunk-mounted CD changer it is located in the rear center storage compartment. See *Rear Storage Area on page 2-42* for more information.

With the trunk-mounted CD changer you can play up to 12 CDs continuously. Normal size CDs may be played using the trays supplied in the magazine. The small CDs (8 cm) can be played only with specially designed trays.

Notice: Heavy objects in the center storage area which may shift or slide while driving could damage your CD changer. Protect your CD changer by not placing heavy, moveable objects in the center storage area.

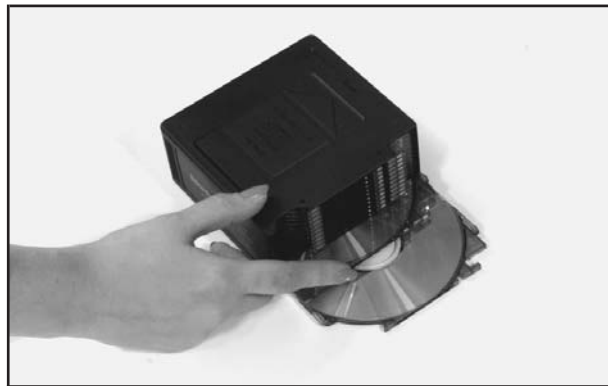

You must first load the magazine with CDs before you can play a CD. Each of the 12 trays holds one CD. Press the button on the back of the magazine and pull gently on one of the trays. Load the trays from bottom to top, placing a CD on the tray label side down. If you load a CD label side up, the CD will not play and an error will occur. Gently push the tray back into the magazine slot. Repeat this procedure for loading up to 12 CDs in the magazine.



Once you have loaded the CDs in the magazine, slide open the door of the CD changer. Push the magazine into the changer in the direction of the arrow marked on top of the magazine.



Close the door by sliding it all the way to the left. If the door is left partially open, the changer will not operate and an error will occur. When the door is closed, the changer will begin checking for CDs in the magazine. This will continue for up to two minutes depending on the number of CDs loaded.

To eject the magazine from the player, slide the CD changer door all the way open. The magazine will automatically eject. Remember to keep the door closed whenever possible to keep dirt and dust from getting inside the changer.

Whenever a CD magazine with CDs is loaded in the changer, the CD symbol will appear on the radio display. If the CD changer is checking the magazine for CDs, the CD symbol will flash on the display until the changer is ready to play. When a CD begins playing, CD will appear in the bottom left corner and a CD and track number will appear on the radio display. The CD numbers are listed on the front of the magazine.

All of the CD functions are controlled by the radio pushbuttons except for ejecting the magazine.

Operating the Trunk-Mounted CD Changer with the Radio with Cassette

If an error appears on the display, see “CD Messages” later in this section.

The following pushbuttons are used for the trunk-mounted CD changer.

1 PREV (Previous): Press this pushbutton to go to the start of the current track if it has been playing for more than eight seconds. If you hold this pushbutton more than once, the player will continue moving backward through the CD.

2 PROG (Program): Press this pushbutton to select the next CD in the magazine. If a CD cannot be played, its number will be skipped when selecting CDs while using this pushbutton.



3 NEXT: Press this pushbutton to go to the next track. If you hold this pushbutton or press it more than once, the player will continue moving forward through the CD.

REV 4 (Reverse): Press and hold this pushbutton to quickly reverse within a track. Release it to play the passage. The elapsed time of the track will appear on the display.

 **5 (Dolby®)**: This pushbutton has no function when playing a CD.

FWD 6 (Forward): Press and hold this pushbutton to quickly advance within a track. Release it to play the passage. The elapsed time of the track will appear on the display.

RECALL: Press this button to see what track is currently playing. Press it again within five seconds to see how long the track has been playing (elapsed time).

 **SEEK**  : The left arrow works the same as the PREV pushbutton and the right arrow works the same as the NEXT pushbutton.

P.SCAN (Preset Scan): Press this button to play the tracks on all of the CDs in random, rather than sequential, order. RDM will appear on the display. Press this button again to turn off random play.

AM/FM: Press this button to listen to the radio when a cassette tape or a CD is playing. The inactive tape or CD will remain safely inside the radio for future listening.

TAPE AUX (Auxiliary): Press this button to play a CD when listening to the radio. You can also press this button to switch between playing a tape in the cassette tape player and playing a CD in the trunk-mounted CD changer, if both are loaded.

Operating the Trunk-Mounted CD Changer with the Radio with CD

If an error appears on the display, see “CD Messages” later in this section.

The following pushbuttons are used for the trunk-mounted CD changer.

1 PREV (Previous): Press this pushbutton to go to the start of the current track if it has been playing for more than eight seconds. If you hold or press this pushbutton more than once, the player will continue moving back through the CD.

2 RDM (Random): Press this pushbutton to play the CDs in random, rather than sequential, order. RDM will appear on the display. Press this pushbutton again to turn off random play.

3 NEXT: Press this pushbutton to go to the next track. If you hold this pushbutton or press it more than once, the player will continue moving forward through the CD.

REV 4 (Reverse): Press and hold this pushbutton to quickly reverse within a track. Release it to play the passage. The elapsed time of the track will appear on the display.

5: Press this pushbutton to select the next CD in the magazine. If a CD cannot be played, its number will be skipped when selecting CDs while using this pushbutton.

FWD 6 (Forward): Press and hold this pushbutton to quickly advance within a track. Release it to play the passage. The elapsed time of the track will appear on the display.

RECALL: Press this button to see what track is currently playing. Press it again within five seconds to see how long the track has been playing (elapsed time).

◀ **SEEK** ▶ : The left arrow works the same as the PREV pushbutton and the right arrow works the same as the NEXT pushbutton.

AM/FM: Press this button to listen to the radio when a CD is playing. The inactive CD will remain safely inside the radio for future listening.

CD AUX (Auxiliary): Press this button to play a CD when listening to the radio. You can also press this button to switch between playing a CD in the CD player and playing a CD in the trunk-mounted CD changer, if both are loaded.

CD Messages

If an error occurs while trying to play a CD in the CD player or changer, the following conditions may have caused the error:

- It is very hot. When the temperature returns to normal, the CD should play.
- You are driving on a very rough road. When the road becomes smooth, the CD should play.
- The CD is dirty, scratched, wet, or upside down.
- The air is very humid. If so, wait about an hour and try again.
- There may have been a problem while burning the CD.
- The label may be caught in the CD player.
- The CD changer door is open. Completely close the changer door to restore normal operation.
- An empty magazine is in the CD changer. Try the magazine again with a CD loaded on one of the trays.

If the CD is not playing correctly, for any other reason, try a known good CD.

If any error occurs repeatedly or if an error cannot be corrected, contact your dealer. If your radio displays an error message, write it down and provide it to your dealer when reporting the problem.

Theft-Deterrent Feature

THEFTLOCK® is designed to discourage theft of your radio. It works by using a secret code to disable all radio functions whenever battery power is interrupted.

The THEFTLOCK feature for the radio may be used or ignored. If ignored, the system plays normally and the radio is not protected by the feature. If THEFTLOCK is activated, your radio will not operate if stolen.

When THEFTLOCK is activated, LOC will appear on the radio display to indicate a locked condition anytime battery power has been interrupted. If your battery loses power for any reason, you must unlock the radio with the secret code before it will operate.

Activating the Theft-Deterrent Feature

The instructions which follow explain how to enter your secret code to activate the THEFTLOCK system. Read through all nine steps before starting the procedure.

If you allow more than 15 seconds to elapse between any steps, the radio automatically reverts to time and you must start the procedure over at Step 4.

1. Write down any three or four-digit number from 000 to 1999 and keep it in a safe place separate from the vehicle.
2. Turn the ignition on.
3. Turn the radio off.
4. Press the 1 and 4 pushbuttons at the same time. Hold them down until --- shows on the display. Next you will use the secret code number which you have written down.
5. Press MN and 000 will appear on the display.
6. Press MN again to make the last two digits agree with your code.
7. Press HR to make the first one or two digits agree with your code.
8. Press AM FM after you have confirmed that the code matches the secret code you have written down. The display will show REP to let you know that you need to repeat Steps 5 through 7 to confirm your secret code.
9. Press AM FM and this time the display will show SEC to let you know that your radio is secure.

Unlocking the Theft-Deterrent Feature After a Power Loss

Enter your secret code as follows; pause no more than 15 seconds between steps:

1. Turn the ignition on. LOC will appear on the display.
2. Press MN and 000 will appear on the display.
3. Press MN again to make the last two digits agree with your code.
4. Press HR to make the first one or two digits agree with your code.
5. Press AM FM after you have confirmed that the code matches the secret code you have written down. The display will show SEC, indicating the radio is now operable and secure.

If you enter the wrong code eight times, INOP will appear on the display. You will have to wait an hour with the ignition on before you can try again. When you try again, you will only have three chances to enter the correct code before INOP appears.

If you lose or forget your code, contact your dealer.

Disabling the Theft-Deterrent Feature

Enter your secret code as follows; pause no more than 15 seconds between steps:

1. Turn the ignition on.
2. Turn the radio off.
3. Press the 1 and 4 pushbuttons at the same time. Hold them down until SEC appears on the display.
4. Press MN and 000 will appear on the display.
5. Press MN again to make the last two digits agree with your code.
6. Press HR to make the first one or two digits agree with your code.
7. Press AM FM after you have confirmed that the code matches the secret code you have written down. --- will appear on the display, indicating that the radio is no longer secured.

If the code entered is incorrect, SEC will appear on the display. The radio will remain secured until the correct code is entered.

When battery power is removed and later applied to a secured radio, the radio won't turn on and LOC will appear on the display.

To unlock a secured radio, see "Unlocking the Theft-Deterrent Feature After a Power Loss" earlier in this section.

Radio Reception

AM

The range for most AM stations is greater than for FM, especially at night. The longer range, however, can cause stations to interfere with each other. AM can pick up noise from things like storms and power lines. Try reducing the treble to reduce this noise.

FM

FM stereo will give you the best sound, but FM signals will reach only about 10 to 40 miles (16 to 65 km). Tall buildings or hills can interfere with FM signals, causing the sound to come and go.

Care of Your Cassette Tape Player

A tape player that is not cleaned regularly can cause reduced sound quality, ruined cassettes, or a damaged mechanism. Cassette tapes should be stored in their cases away from contaminants, direct sunlight, and extreme heat. If they are not, they may not operate properly or may cause failure of the tape player.

Your tape player should be cleaned regularly after every 50 hours of use. Your radio may display CLN to indicate that you have used your tape player for 50 hours without resetting the tape clean timer.

If this message appears on the display, your cassette tape player needs to be cleaned. It will still play tapes, but you should clean it as soon as possible to prevent damage to your tapes and player. If you notice a reduction in sound quality, try a known good cassette to see if the tape or the tape player is at fault. If this other cassette has no improvement in sound quality, clean the tape player.

For best results, use a scrubbing action, non-abrasive cleaning cassette with pads which scrub the tape head as the hubs of the cleaner cassette turn. The recommended cleaning cassette is available through your dealer.

The cut tape detection feature of your cassette tape player may identify the cleaning cassette as a damaged tape, in error. To prevent the cleaning cassette from being ejected, use the following steps:

1. Turn the ignition on.
2. Turn the radio off.
3. Press and hold the TAPE AUX button for five seconds. The tape symbol on the display will flash for two seconds.
4. Insert the scrubbing action cleaning cassette.
5. Eject the cleaning cassette after the manufacturer's recommended cleaning time.

After the cleaning cassette is ejected, the cut tape detection feature will be active again.

You may also choose a non-scrubbing action, wet-type cleaner which uses a cassette with a fabric belt to clean the tape head. This type of cleaning cassette will not eject on its own. A non-scrubbing action cleaner may not clean as thoroughly as the scrubbing type cleaner. The use of a non-scrubbing action, dry-type cleaning cassette is not recommended.

After you clean the player, press and hold the EJECT button for five seconds to reset the CLN indicator. The radio will display --- or CLEANED to show the indicator was reset.

Cassettes are subject to wear and the sound quality may degrade over time. Always make sure the cassette tape is in good condition before you have your tape player serviced.

Care of Your CDs

Handle CDs carefully. Store them in their original cases or other protective cases and away from direct sunlight and dust. If the surface of a CD is soiled, dampen a clean, soft cloth in a mild, neutral detergent solution and clean it, wiping from the center to the edge.

Be sure never to touch the side without writing when handling CDs. Pick up CDs by grasping the outer edges or the edge of the hole and the outer edge.

Care of Your CD Player

The use of CD lens cleaners for CDs is not advised, due to the risk of contaminating the lens of the CD optics with lubricants internal to the CD mechanism.

Fixed Mast Antenna (Z06)

The fixed mast antenna can withstand most car washes without being damaged. If the mast should ever become slightly bent, you can straighten it out by hand. If the mast is badly bent, you should replace it.

Check occasionally to be sure the mast is still tightened to the rear quarter panel.

Power Antenna Mast Care (Convertible)

Your power antenna will look its best and work well if it is cleaned from time to time. To clean the antenna mast do the following:

1. Turn on the ignition and radio to raise the antenna.
2. Dampen a clean cloth with mineral spirits or equivalent solvent.
3. Wipe the cloth over the mast sections, removing any dirt.
4. Wipe dry with a clean cloth.
5. Make the antenna go up and down by turning the radio or ignition off and on.
6. Repeat if necessary.

Notice: If you lubricate the power antenna, you may damage it. Always follow the cleaning instructions listed in this manual to keep the power antenna working properly.

Notice: Before entering an automatic car wash, turn off your radio to make the power antenna go down. This will prevent the mast from possible damage. If the antenna does not go down when you turn the radio off, it may be damaged or need to be cleaned. In either case, lower the antenna by hand by carefully pressing the antenna down.

If the mast portion of your antenna is damaged, you can replace it. See your dealer for a replacement kit and follow the instructions in the kit.

Integrated Windshield and Rear Window Antennas (Coupe)

The antennas in your vehicle are located in the windshield and the rear window. The front connector is at the top of the windshield and the rear antenna is incorporated in the rear window defogger grid.

Notice: Do not apply aftermarket glass tinting with metallic film. The metallic film in some tinting materials will interfere with or distort the incoming radio reception. Any damage caused to your backglass antenna due to metallic tinting materials will not be covered by your warranty.

Section 4 Driving Your Vehicle

Your Driving, the Road, and Your Vehicle	4-2	Driving in Rain and on Wet Roads	4-20
Defensive Driving	4-2	City Driving	4-23
Drunken Driving	4-3	Freeway Driving	4-24
Control of a Vehicle	4-6	Before Leaving on a Long Trip	4-25
Braking	4-6	Highway Hypnosis	4-26
Traction Control System (TCS)	4-9	Hill and Mountain Roads	4-26
Active Handling System	4-10	Winter Driving	4-28
Limited-Slip Rear Axle	4-12	If You Are Stuck: In Sand, Mud, Ice or Snow	4-32
Selective Ride Control	4-12	Towing	4-33
Steering	4-14	Towing Your Vehicle	4-33
Off-Road Recovery	4-16	Recreational Vehicle Towing	4-33
Passing	4-16	Loading Your Vehicle	4-33
Loss of Control	4-18	Towing a Trailer	4-38
Driving at Night	4-19		

Your Driving, the Road, and Your Vehicle

Defensive Driving

The best advice anyone can give about driving is: Drive defensively.

Please start with a very important safety device in your vehicle: Buckle up. See *Safety Belts: They Are for Everyone* on page 1-6.

Defensive driving really means “be ready for anything.” On city streets, rural roads or freeways, it means “always expect the unexpected.”

Assume that pedestrians or other drivers are going to be careless and make mistakes. Anticipate what they might do. Be ready for their mistakes.

Rear-end collisions are about the most preventable of accidents. Yet they are common. Allow enough following distance. It is the best defensive driving maneuver, in both city and rural driving. You never know when the vehicle in front of you is going to brake or turn suddenly.

Defensive driving requires that a driver concentrate on the driving task. Anything that distracts from the driving task — such as concentrating on a cellular telephone call, reading, or reaching for something on the floor — makes proper defensive driving more difficult and can even cause a collision, with resulting injury. Ask a passenger to help do things like this, or pull off the road in a safe place to do them yourself. These simple defensive driving techniques could save your life.

Drunken Driving

Death and injury associated with drinking and driving is a national tragedy. It is the number one contributor to the highway death toll, claiming thousands of victims every year.

Alcohol affects four things that anyone needs to drive a vehicle:

- Judgment
- Muscular Coordination
- Vision
- Attentiveness.

Police records show that almost half of all motor vehicle-related deaths involve alcohol. In most cases, these deaths are the result of someone who was drinking and driving. In recent years, more than 16,000 annual motor vehicle-related deaths have been associated with the use of alcohol, with more than 300,000 people injured.

Many adults — by some estimates, nearly half the adult population — choose never to drink alcohol, so they never drive after drinking. For persons under 21, it is against the law in every U.S. state to drink alcohol. There are good medical, psychological and developmental reasons for these laws.

The obvious way to eliminate the leading highway safety problem is for people never to drink alcohol and then drive. But what if people do? How much is “too much” if someone plans to drive? It is a lot less than many might think. Although it depends on each person and situation, here is some general information on the problem.

The Blood Alcohol Concentration (BAC) of someone who is drinking depends upon four things:

- The amount of alcohol consumed
- The drinker’s body weight
- The amount of food that is consumed before and during drinking
- The length of time it has taken the drinker to consume the alcohol.

According to the American Medical Association, a 180 lb (82 kg) person who drinks three 12 ounce (355 ml) bottles of beer in an hour will end up with a BAC of about 0.06 percent. The person would reach the same BAC by drinking three 4 ounce (120 ml) glasses of wine or three mixed drinks if each had 1-1/2 ounces (45 ml) of liquors like whiskey, gin or vodka.



It is the amount of alcohol that counts. For example, if the same person drank three double martinis (3 ounces or 90 ml of liquor each) within an hour, the person's BAC would be close to 0.12 percent. A person who consumes food just before or during drinking will have a somewhat lower BAC level.

There is a gender difference, too. Women generally have a lower relative percentage of body water than men. Since alcohol is carried in body water, this means that a woman generally will reach a higher BAC level than a man of her same body weight will when each has the same number of drinks.

The law in an increasing number of U.S. states, and throughout Canada, sets the legal limit at 0.08 percent. In some other countries, the limit is even lower. For example, it is 0.05 percent in both France and Germany. The BAC limit for all commercial drivers in the United States is 0.04 percent.

The BAC will be over 0.10 percent after three to six drinks (in one hour). Of course, as we have seen, it depends on how much alcohol is in the drinks, and how quickly the person drinks them.

But the ability to drive is affected well below a BAC of 0.10 percent. Research shows that the driving skills of many people are impaired at a BAC approaching 0.05 percent, and that the effects are worse at night. All drivers are impaired at BAC levels above 0.05 percent. Statistics show that the chance of being in a collision increases sharply for drivers who have a BAC of 0.05 percent or above. A driver with a BAC level of 0.06 percent has doubled his or her chance of having a collision. At a BAC level of 0.10 percent, the chance of this driver having a collision is 12 times greater; at a level of 0.15 percent, the chance is 25 times greater!

The body takes about an hour to rid itself of the alcohol in one drink. No amount of coffee or number of cold showers will speed that up. “I will be careful” is not the right answer. What if there is an emergency, a need to take sudden action, as when a child darts into the street? A person with even a moderate BAC might not be able to react quickly enough to avoid the collision.

There is something else about drinking and driving that many people do not know. Medical research shows that alcohol in a person’s system can make crash injuries worse, especially injuries to the brain, spinal cord or heart. This means that when anyone who has been drinking — driver or passenger — is in a crash, that person’s chance of being killed or permanently disabled is higher than if the person had not been drinking.

 **CAUTION:**

Drinking and then driving is very dangerous. Your reflexes, perceptions, attentiveness and judgment can be affected by even a small amount of alcohol. You can have a serious — or even fatal — collision if you drive after drinking. Please do not drink and drive or ride with a driver who has been drinking. Ride home in a cab; or if you are with a group, designate a driver who will not drink.

Control of a Vehicle

You have three systems that make your vehicle go where you want it to go. They are the brakes, the steering and the accelerator. All three systems have to do their work at the places where the tires meet the road.

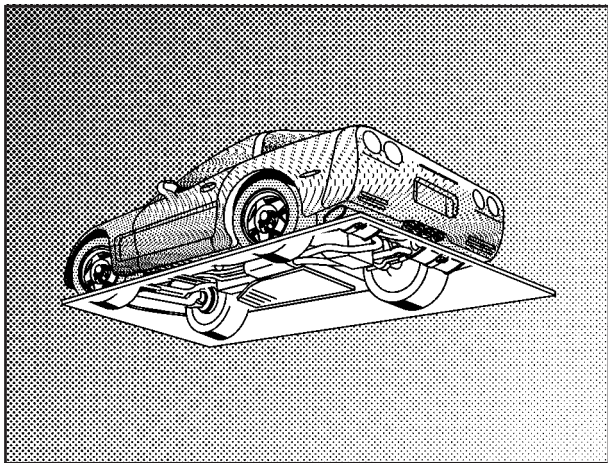

Sometimes, as when you are driving on snow or ice, it is easy to ask more of those control systems than the tires and road can provide. That means you can lose control of your vehicle. Also see *Traction Control System (TCS)* on page 4-9 and *Active Handling System* on page 4-10.

Braking

Braking action involves *perception time* and *reaction time*.

First, you have to decide to push on the brake pedal. That is *perception time*. Then you have to bring up your foot and do it. That is *reaction time*.

Average *reaction time* is about 3/4 of a second. But that is only an average. It might be less with one driver and as long as two or three seconds or more with another. Age, physical condition, alertness, coordination and eyesight all play a part. So do alcohol, drugs and frustration. But even in 3/4 of a second, a vehicle moving at 60 mph (100 km/h) travels 66 feet (20 m). That could be a lot of distance in an emergency, so keeping enough space between your vehicle and others is important.

And, of course, actual stopping distances vary greatly with the surface of the road (whether it is pavement or gravel); the condition of the road (wet, dry, icy); tire tread; the condition of your brakes; the weight of the vehicle and the amount of brake force applied.

Avoid needless heavy braking. Some people drive in spurts — heavy acceleration followed by heavy braking — rather than keeping pace with traffic. This is a mistake. Your brakes may not have time to cool between hard stops. Your brakes will wear out much faster if you do a lot of heavy braking. If you keep pace with the traffic and allow realistic following distances, you will eliminate a lot of unnecessary braking. That means better braking and longer brake life.

If your engine ever stops while you are driving, brake normally but do not pump your brakes. If you do, the pedal may get harder to push down. If your engine stops, you will still have some power brake assist. But you will use it when you brake. Once the power assist is used up, it may take longer to stop and the brake pedal will be harder to push.

Anti-lock Brake System (ABS)

Your vehicle has anti-lock brakes. ABS is an advanced electronic braking system that will help prevent a braking skid.

When you start your engine and begin to drive away, your anti-lock brake system will check itself. You may hear a momentary motor or clicking noise while this test is going on, and you may even notice that your brake pedal moves a little. This is normal.

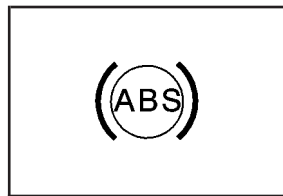

If there is a problem with the anti-lock brake system, this warning light will stay on. See *Anti-Lock Brake System Warning Light* on page 3-39.



Let us say the road is wet and you are driving safely. Suddenly, an animal jumps out in front of you. You slam on the brakes and continue braking. Here is what happens with ABS:

A computer senses that wheels are slowing down. If one of the wheels is about to stop rolling, the computer will separately work the brakes at each wheel.

The anti-lock system can change the brake pressure faster than any driver could. The computer is programmed to make the most of available tire and road conditions. This can help you steer around the obstacle while braking hard.



As you brake, your computer keeps receiving updates on wheel speed and controls braking pressure accordingly.

Remember: Anti-lock does not change the time you need to get your foot up to the brake pedal or always decrease stopping distance. If you get too close to the vehicle in front of you, you will not have time to apply your brakes if that vehicle suddenly slows or stops. Always leave enough room up ahead to stop, even though you have anti-lock brakes.

Using Anti-Lock

Do not pump the brakes. Just hold the brake pedal down firmly and let anti-lock work for you. You may hear a motor or clicking noise and feel the brake pedal move a little during a stop, but this is normal.

Braking in Emergencies

With anti-lock, you can steer and brake at the same time. In many emergencies, steering can help you more than even the very best braking.

Traction Control System (TCS)

Your vehicle has a traction control system called TCS that limits wheel spin. This is especially useful in slippery road conditions. The system operates only if it senses that the rear wheels are spinning too much or are beginning to lose traction. When this happens, the system works the rear brakes and reduces engine power (by closing the throttle and managing engine spark) to limit wheel spin.

The TRACTION SYS ACTIVE message will come on when the TCS system is limiting wheel spin. See *DIC Warnings and Messages on page 3-58*. You may feel or hear the system working, but this is normal.

If your vehicle is in cruise control when the TCS system begins to limit wheel spin, the cruise control will automatically disengage. When road conditions allow you to safely use it again, you may re-engage the cruise control. See *Turn Signal/Multifunction Lever on page 3-6*.

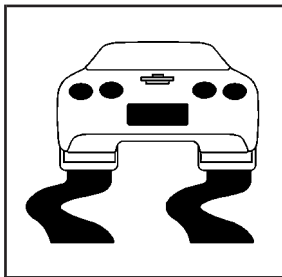

The SERVICE TRACTION SYSTEM message and the TCS warning light will come on to let you know if there is a problem with your TCS system. See *DIC Warnings and Messages on page 3-58*.

When this light and the SERVICE TRACTION SYSTEM message are on, the system will not limit wheel spin. Adjust your driving accordingly.

The TCS system automatically comes on whenever you start your vehicle. To limit wheel spin, especially in slippery road conditions, you should always leave the system on. But you can turn the TCS system off if you ever need to.

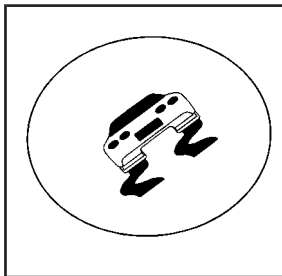

To turn the system off, press the button located on the console. You can turn the system on or off at any time by pressing the ACTIVE HANDLING button. The DIC will display the appropriate message when you push the button.

Active Handling System

The Active Handling System is a computer controlled system that helps the driver maintain directional control of the vehicle in difficult driving conditions. This is accomplished by selectively applying any one of the vehicle's brakes.

When you first start your vehicle and begin to drive away (6 mph (10 km/h)), the message ACT HNDLG WARMING UP may be displayed in the DIC, the instrument cluster light will be on, and a chime will sound. This is normal. You can acknowledge this message by pressing the RESET button. The Active Handling System performance is affected until the message, WARM UP COMPLETE, is displayed in the DIC.

The ACT HNDLG WARMING UP message may be displayed in the DIC after exceeding 12 mph (20 km/h) for 30 seconds. The Active Handling System is off until the WARM UP COMPLETE message is displayed.

The ACTIVE HANDLING message will come on when the system is operating. See *DIC Warnings and Messages on page 3-58* for more information. You may also feel or hear the system working. This is normal.

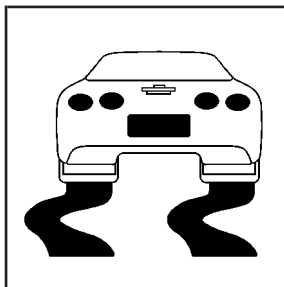

The SERVICE ACTIVE HNDLG message will be displayed, the instrument cluster light will come on, and a chime will sound to let you know if there is a problem with the system. See *DIC Warnings and Messages on page 3-58* for more information.

When this light and the SERVICE ACTIVE HNDLG message are on, the system is not operational. Adjust your driving accordingly.

The Active Handling System comes on automatically whenever you start your vehicle. To help maintain directional control of the vehicle, you should always leave the system on. You can turn the system off if you ever need to. If you turn the Active Handling System off, the Traction Control System will also be turned off. Adjust your driving accordingly.

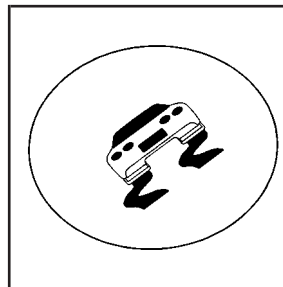

To turn the system off, press the ACTIVE HANDLING button on the console. You can turn the system on and off at any time by pressing the button. The DIC will display the appropriate message when you push the button.

Competitive Driving Mode

The driver can select this optional handling mode by pressing the ACTIVE HANDLING button on the console for more than five seconds. A chime will sound and COMPETITIVE DRIVING will be displayed in the DIC. Competitive Driving mode allows the driver to have full control of the rear wheels while the Active Handling System helps steer the vehicle by selective brake application. The instrument cluster light will not be on. The Traction Control System will not be operating. Adjust your driving accordingly.

When you press the ACTIVE HANDLING button again, or turn the ignition to ACC, the Active Handling and Traction Control Systems will be on. The TRAC/ACT HNDLG-ON message will be displayed temporarily in the DIC and a chime will be heard.

Limited-Slip Rear Axle

Your limited-slip rear axle can give you additional traction on snow, mud, ice, sand or gravel. It works like a standard axle most of the time, but when one of the rear wheels has no traction and the other does, this feature will allow the wheel with traction to move the vehicle.

Selective Ride Control

You may have a ride control system on your vehicle called Selective Ride Control. The system provides the following performance benefits:

- Reduced Impact Harshness
- Improved Road Isolation
- Improved High-Speed Stability
- Improved Handling Response
- Better Control of Body Ride Motions

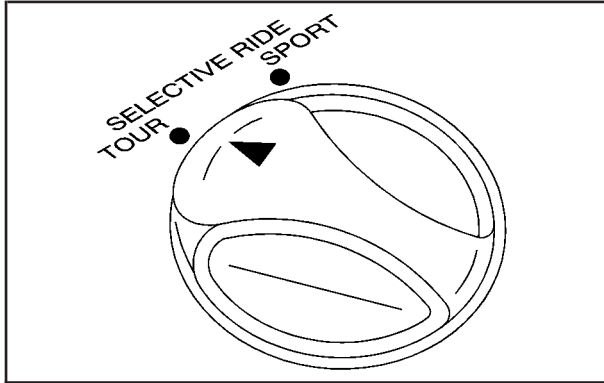

This knob is located on the center console. Turn it to select the suspension of your choice.

TOUR: Use for normal city and highway driving. This setting provides a smooth, soft ride.

SPORT: Use where road conditions or personal preference demand more control. This setting provides more “feel”, or response to the road conditions.

You can select a setting at any time. Based on road conditions, steering wheel angle and your vehicle speed, the system automatically adjusts to provide the best ride and handling. Select a new setting whenever driving conditions change.

There are three Driver Information Center (DIC) messages that are displayed when a malfunction occurs with the Selective Ride Control system. Refer to *DIC Warnings and Messages on page 3-58*.

Steering

Power Steering

If you lose power steering assist because the engine stops or the system is not functioning, you can steer but it will take much more effort.

Magnetic Speed Variable Assist Steering

Your vehicle is equipped with a steering system that continuously adjusts the effort you feel when steering at all vehicle speeds. It provides ease when parking, yet a firm, solid feel at highway speeds.

Steering Tips

Driving on Curves

It is important to take curves at a reasonable speed.

A lot of the “driver lost control” accidents mentioned on the news happen on curves. Here is why:

Experienced driver or beginner, each of us is subject to the same laws of physics when driving on curves.

The traction of the tires against the road surface makes it possible for the vehicle to change its path when you turn the front wheels. If there is no traction, inertia will keep the vehicle going in the same direction.

If you have ever tried to steer a vehicle on wet ice, you will understand this.

The traction you can get in a curve depends on the condition of your tires and the road surface, the angle at which the curve is banked, and your speed. While you are in a curve, speed is the one factor you can control.

Suppose you are steering through a sharp curve. Then you suddenly accelerate. Both control systems — steering and acceleration — have to do their work where the tires meet the road. Adding the sudden acceleration can demand too much of those places. You can lose control. See *Traction Control System (TCS) on page 4-9*.

What should you do if this ever happens? Ease up on the accelerator pedal, steer the vehicle the way you want it to go, and slow down.

Speed limit signs near curves warn that you should adjust your speed. Of course, the posted speeds are based on good weather and road conditions. Under less favorable conditions you will want to go slower.

If you need to reduce your speed as you approach a curve, do it before you enter the curve, while your front wheels are straight ahead.

Try to adjust your speed so you can “drive” through the curve. Maintain a reasonable, steady speed. Wait to accelerate until you are out of the curve, and then accelerate gently into the straightaway.

Steering in Emergencies

There are times when steering can be more effective than braking. For example, you come over a hill and find a truck stopped in your lane, or a car suddenly pulls out from nowhere, or a child darts out from between parked cars and stops right in front of you. You can avoid these problems by braking — if you can stop in time. But sometimes you can not; there is not room. That is the time for evasive action — steering around the problem.

Your vehicle can perform very well in emergencies like these. First apply your brakes.

See *Braking on page 4-6*. It is better to remove as much speed as you can from a possible collision. Then steer around the problem, to the left or right depending on the space available.

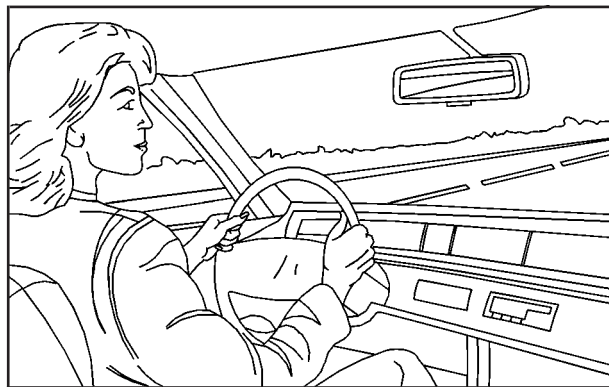

An emergency like this requires close attention and a quick decision. If you are holding the steering wheel at the recommended 9 and 3 o'clock positions, you can turn it a full 180 degrees very quickly without removing either hand. But you have to act fast, steer quickly, and just as quickly straighten the wheel once you have avoided the object.

The fact that such emergency situations are always possible is a good reason to practice defensive driving at all times and wear safety belts properly.

Off-Road Recovery

You may find that your right wheels have dropped off the edge of a road onto the shoulder while you're driving.

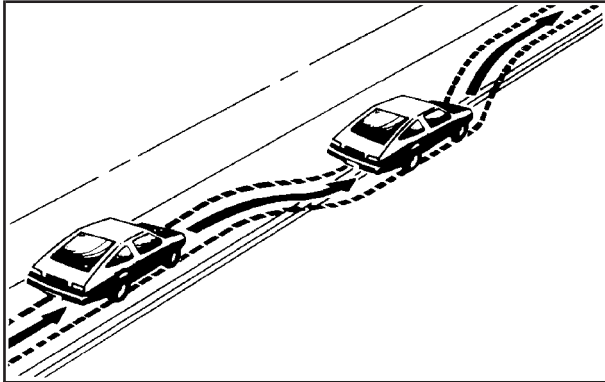

If the level of the shoulder is only slightly below the pavement, recovery should be fairly easy. Ease off the accelerator and then, if there is nothing in the way, steer so that your vehicle straddles the edge of the pavement. You can turn the steering wheel up to one-quarter turn until the right front tire contacts the pavement edge. Then turn your steering wheel to go straight down the roadway.

Passing

The driver of a vehicle about to pass another on a two-lane highway waits for just the right moment, accelerates, moves around the vehicle ahead, then goes back into the right lane again. A simple maneuver?

Not necessarily! Passing another vehicle on a two-lane highway is a potentially dangerous move, since the passing vehicle occupies the same lane as oncoming traffic for several seconds. A miscalculation, an error in judgment, or a brief surrender to frustration or anger can suddenly put the passing driver face to face with the worst of all traffic accidents — the head-on collision.

So here are some tips for passing:

- “Drive ahead.” Look down the road, to the sides and to crossroads for situations that might affect your passing patterns. If you have any doubt whatsoever about making a successful pass, wait for a better time.
- Watch for traffic signs, pavement markings and lines. If you can see a sign up ahead that might indicate a turn or an intersection, delay your pass. A broken center line usually indicates it is all right to pass (providing the road ahead is clear). Never cross a solid line on your side of the lane or a double solid line, even if the road seems empty of approaching traffic.

- Do not get too close to the vehicle you want to pass while you are awaiting an opportunity. For one thing, following too closely reduces your area of vision, especially if you are following a larger vehicle. Also, you will not have adequate space if the vehicle ahead suddenly slows or stops. Keep back a reasonable distance.
- When it looks like a chance to pass is coming up, start to accelerate but stay in the right lane and do not get too close. Time your move so you will be increasing speed as the time comes to move into the other lane. If the way is clear to pass, you will have a “running start” that more than makes up for the distance you would lose by dropping back. And if something happens to cause you to cancel your pass, you need only slow down and drop back again and wait for another opportunity.
- If other vehicles are lined up to pass a slow vehicle, wait your turn. But take care that someone is not trying to pass you as you pull out to pass the slow vehicle. Remember to glance over your shoulder and check the blind spot.
- Check your mirrors, glance over your shoulder, and start your left lane change signal before moving out of the right lane to pass. When you are far enough ahead of the passed vehicle to see its front in your inside mirror, activate your right lane change signal and move back into the right lane. (Remember that your right outside mirror is convex. The vehicle you just passed may seem to be farther away from you than it really is.)
- Try not to pass more than one vehicle at a time on two-lane roads. Reconsider before passing the next vehicle.
- Do not overtake a slowly moving vehicle too rapidly. Even though the brake lamps are not flashing, it may be slowing down or starting to turn.
- If you are being passed, make it easy for the following driver to get ahead of you. Perhaps you can ease a little to the right.

Loss of Control

Let us review what driving experts say about what happens when the three control systems (brakes, steering and acceleration) do not have enough friction where the tires meet the road to do what the driver has asked.

In any emergency, do not give up. Keep trying to steer and constantly seek an escape route or area of less danger.

Skidding

In a skid, a driver can lose control of the vehicle. Defensive drivers avoid most skids by taking reasonable care suited to existing conditions, and by not “overdriving” those conditions. But skids are always possible.

The three types of skids correspond to your vehicle’s three control systems. In the braking skid, your wheels are not rolling. In the steering or cornering skid, too much speed or steering in a curve causes tires to slip and lose cornering force. And in the acceleration skid, too much throttle causes the driving wheels to spin.

A cornering skid is best handled by easing your foot off the accelerator pedal.

Remember: Any traction control system helps avoid only the acceleration skid. If your TCS system is off, then an acceleration skid is also best handled by easing your foot off the accelerator pedal.

If your vehicle starts to slide, ease your foot off the accelerator pedal and quickly steer the way you want the vehicle to go. If you start steering quickly enough, your vehicle may straighten out. Always be ready for a second skid if it occurs.

Of course, traction is reduced when water, snow, ice, gravel or other material is on the road. For safety, you will want to slow down and adjust your driving to these conditions. It is important to slow down on slippery surfaces because stopping distance will be longer and vehicle control more limited.

While driving on a surface with reduced traction, try your best to avoid sudden steering, acceleration or braking (including engine braking by shifting to a lower gear). Any sudden changes could cause the tires to slide. You may not realize the surface is slippery until your vehicle is skidding. Learn to recognize warning clues — such as enough water, ice or packed snow on the road to make a “mirrored surface” — and slow down when you have any doubt.

Remember: Any anti-lock brake system (ABS) helps avoid only the braking skid.

Driving at Night

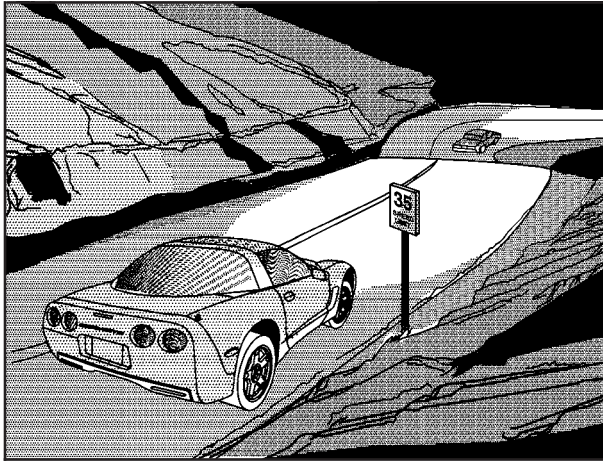

Night driving is more dangerous than day driving. One reason is that some drivers are likely to be impaired — by alcohol or drugs, with night vision problems, or by fatigue.

Here are some tips on night driving.

- Drive defensively.
- Do not drink and drive.
- Adjust your inside rearview mirror to reduce the glare from headlamps behind you.
- Since you can not see as well, you may need to slow down and keep more space between you and other vehicles.
- Slow down, especially on higher speed roads. Your headlamps can light up only so much road ahead.
- In remote areas, watch for animals.
- If you are tired, pull off the road in a safe place and rest.

No one can see as well at night as in the daytime. But as we get older these differences increase. A 50-year-old driver may require at least twice as much light to see the same thing at night as a 20-year-old.

What you do in the daytime can also affect your night vision. For example, if you spend the day in bright sunshine you are wise to wear sunglasses. Your eyes will have less trouble adjusting to night. But if you are driving, do not wear sunglasses at night. They may cut down on glare from headlamps, but they also make a lot of things invisible.

Driving in Rain and on Wet Roads

You can be temporarily blinded by approaching headlamps. It can take a second or two, or even several seconds, for your eyes to readjust to the dark. When you are faced with severe glare (as from a driver who does not lower the high beams, or a vehicle with misaimed headlamps), slow down a little. Avoid staring directly into the approaching headlamps.

Keep your windshield and all the glass on your vehicle clean — inside and out. Glare at night is made much worse by dirt on the glass. Even the inside of the glass can build up a film caused by dust. Dirty glass makes lights dazzle and flash more than clean glass would, making the pupils of your eyes contract repeatedly.

Remember that your headlamps light up far less of a roadway when you are in a turn or curve. Keep your eyes moving; that way, it is easier to pick out dimly lighted objects. Just as your headlamps should be checked regularly for proper aim, so should your eyes be examined regularly. Some drivers suffer from night blindness — the inability to see in dim light — and are not even aware of it.

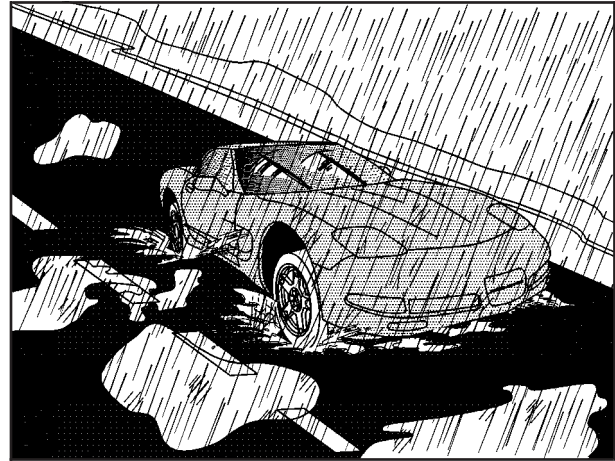

Rain and wet roads can mean driving trouble. On a wet road, you can not stop, accelerate or turn as well because your tire-to-road traction is not as good as on dry roads. And, if your tires do not have much tread left, you will get even less traction. It is always wise to go slower and be cautious if rain starts to fall while you are driving. The surface may get wet suddenly when your reflexes are tuned for driving on dry pavement.

The heavier the rain, the harder it is to see. Even if your windshield wiper blades are in good shape, a heavy rain can make it harder to see road signs and traffic signals, pavement markings, the edge of the road and even people walking.

It is wise to keep your windshield wiping equipment in good shape and keep your windshield washer tank filled with washer fluid. Replace your windshield wiper inserts when they show signs of streaking or missing areas on the windshield, or when strips of rubber start to separate from the inserts.

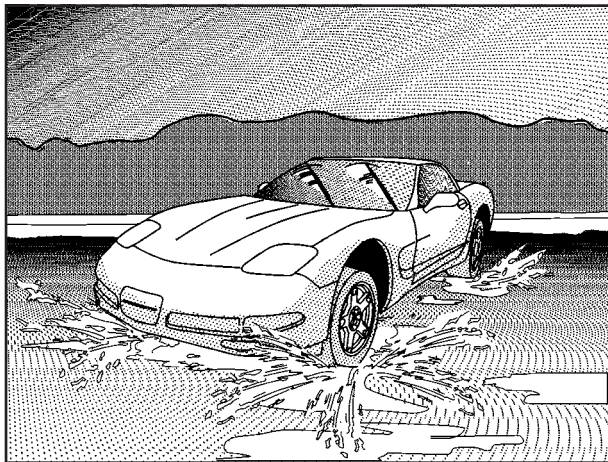

Driving too fast through large water puddles or even going through some car washes can cause problems, too. The water may affect your brakes. Try to avoid puddles. But if you can not, try to slow down before you hit them.

⚠ CAUTION:

Wet brakes can cause accidents. They will not work as well in a quick stop and may cause pulling to one side. You could lose control of the vehicle.

After driving through a large puddle of water or a car wash, apply your brake pedal lightly until your brakes work normally.

Hydroplaning

Hydroplaning is dangerous. So much water can build up under your tires that they can actually ride on the water. This can happen if the road is wet enough and you are going fast enough. When your vehicle is hydroplaning, it has little or no contact with the road.

Hydroplaning does not happen often. But it can if your tires do not have much tread or if the pressure is one or more is low. It can happen if a lot of water is standing on the road. If you can see reflections from trees, telephone poles, or other vehicles, and raindrops “dimple” the water’s surface, there could be hydroplaning.

Hydroplaning usually happens at higher speeds. There just is not a hard and fast rule about hydroplaning. The best advice is to slow down when it is raining.

Driving Through Deep Standing Water

Notice: If you drive too quickly through deep puddles or standing water, water can come in through your engine’s air intake and badly damage your engine. Never drive through water that is slightly lower than the underbody of your vehicle. If you can not avoid deep puddles or standing water, drive through them very slowly.

Driving Through Flowing Water

CAUTION:

Flowing or rushing water creates strong forces. If you try to drive through flowing water, as you might at a low water crossing, your vehicle can be carried away. As little as six inches of flowing water can carry away a smaller vehicle. If this happens, you and other vehicle occupants could drown. Do not ignore police warning signs, and otherwise be very cautious about trying to drive through flowing water.

Some Other Rainy Weather Tips

- Besides slowing down, allow some extra following distance. And be especially careful when you pass another vehicle. Allow yourself more clear room ahead, and be prepared to have your view restricted by road spray.
- Have good tires with proper tread depth. See *Tires* on page 5-55.

City Driving



One of the biggest problems with city streets is the amount of traffic on them. You will want to watch out for what the other drivers are doing and pay attention to traffic signals.

Here are ways to increase your safety in city driving:

- Know the best way to get to where you are going. Get a city map and plan your trip into an unknown part of the city just as you would for a cross-country trip.
- Try to use the freeways that rim and crisscross most large cities. You will save time and energy. See *Freeway Driving on page 4-24*.
- Treat a green light as a warning signal. A traffic light is there because the corner is busy enough to need it. When a light turns green, and just before you start to move, check both ways for vehicles that have not cleared the intersection or may be running the red light.

Freeway Driving

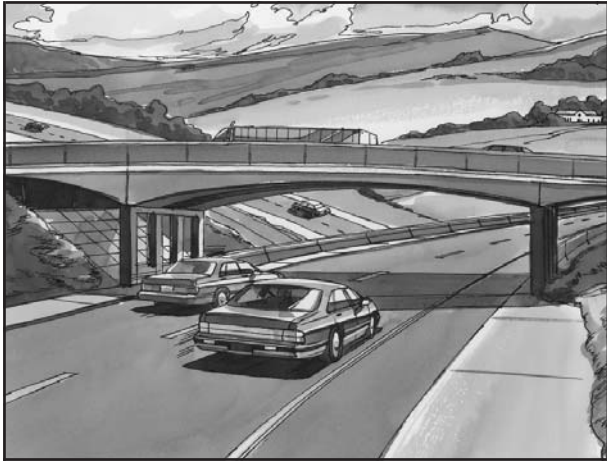

Mile for mile, freeways (also called thruways, parkways, expressways, turnpikes or superhighways) are the safest of all roads. But they have their own special rules.

The most important advice on freeway driving is: Keep up with traffic and keep to the right. Drive at the same speed most of the other drivers are driving. Too-fast or too-slow driving breaks a smooth traffic flow. Treat the left lane on a freeway as a passing lane.

At the entrance, there is usually a ramp that leads to the freeway. If you have a clear view of the freeway as you drive along the entrance ramp, you should begin to check traffic. Try to determine where you expect to blend with the flow. Try to merge into the gap at close to the prevailing speed. Switch on your turn signal, check your mirrors and glance over your shoulder as often as necessary. Try to blend smoothly with the traffic flow.

Once you are on the freeway, adjust your speed to the posted limit or to the prevailing rate if it is slower. Stay in the right lane unless you want to pass.

Before changing lanes, check your mirrors. Then use your turn signal.

Just before you leave the lane, glance quickly over your shoulder to make sure there is not another vehicle in your “blind” spot.

Once you are moving on the freeway, make certain you allow a reasonable following distance.

Expect to move slightly slower at night.

When you want to leave the freeway, move to the proper lane well in advance. If you miss your exit, do not, under any circumstances, stop and back up. Drive on to the next exit.

The exit ramp can be curved, sometimes quite sharply. The exit speed is usually posted. Reduce your speed according to your speedometer, not to your sense of motion. After driving for any distance at higher speeds, you may tend to think you are going slower than you actually are.

Before Leaving on a Long Trip

Make sure you are ready. Try to be well rested. If you must start when you are not fresh — such as after a day's work — do not plan to make too many miles that first part of the journey. Wear comfortable clothing and shoes you can easily drive in.

Is your vehicle ready for a long trip? If you keep it serviced and maintained, it is ready to go. If it needs service, have it done before starting out. Of course, you will find experienced and able service experts in GM dealerships all across North America. They will be ready and willing to help if you need it.

Here are some things you can check before a trip:

- *Windshield Washer Fluid*: Is the reservoir full? Are all windows clean inside and outside?
- *Wiper Blades*: Are they in good shape?
- *Fuel, Engine Oil, Other Fluids*: Have you checked all levels?
- *Lamps*: Are they all working? Are the lenses clean?
- *Tires*: They are vitally important to a safe, trouble-free trip. Is the tread good enough for long-distance driving? Are the tires all inflated to the recommended pressure?
- *Weather Forecasts*: What is the weather outlook along your route? Should you delay your trip a short time to avoid a major storm system?
- *Maps*: Do you have up-to-date maps?

Highway Hypnosis

Is there actually such a condition as “highway hypnosis”? Or is it just plain falling asleep at the wheel? Call it highway hypnosis, lack of awareness, or whatever.

There is something about an easy stretch of road with the same scenery, along with the hum of the tires on the road, the drone of the engine, and the rush of the wind against the vehicle that can make you sleepy. Do not let it happen to you! If it does, your vehicle can leave the road in *less than a second*, and you could crash and be injured.

What can you do about highway hypnosis? First, be aware that it can happen.

Then here are some tips:

- Make sure your vehicle is well ventilated, with a comfortably cool interior.
- Keep your eyes moving. Scan the road ahead and to the sides. Check your rearview mirrors and your instruments frequently.
- If you get sleepy, pull off the road into a rest, service or parking area and take a nap, get some exercise, or both. For safety, treat drowsiness on the highway as an emergency.

Hill and Mountain Roads



Driving on steep hills or mountains is different from driving in flat or rolling terrain.

If you drive regularly in steep country, or if you are planning to visit there, here are some tips that can make your trips safer and more enjoyable.

- Keep your vehicle in good shape. Check all fluid levels and also the brakes, tires, cooling system and transmission. These parts can work hard on mountain roads.
- Know how to go down hills. The most important thing to know is this: let your engine do some of the slowing down. Shift to a lower gear when you go down a steep or long hill.

 **CAUTION:**

If you do not shift down, your brakes could get so hot that they would not work well. You would then have poor braking or even none going down a hill. You could crash. Shift down to let your engine assist your brakes on a steep downhill slope.

 **CAUTION:**

Coasting downhill in NEUTRAL (N) or with the ignition off is dangerous. Your brakes will have to do all the work of slowing down. They could get so hot that they would not work well. You would then have poor braking or even none going down a hill. You could crash. Always have your engine running and your vehicle in gear when you go downhill.

- Know how to go uphill. You may want to shift down to a lower gear. The lower gears help cool your engine and transmission, and you can climb the hill better.
- Stay in your own lane when driving on two-lane roads in hills or mountains. Do not swing wide or cut across the center of the road. Drive at speeds that let you stay in your own lane.
- As you go over the top of a hill, be alert. There could be something in your lane, like a stalled car or an accident.
- You may see highway signs on mountains that warn of special problems. Examples are long grades, passing or no-passing zones, a falling rocks area or winding roads. Be alert to these and take appropriate action.

Winter Driving



Here are some tips for winter driving:

- Have your vehicle in good shape for winter.
- You may want to put winter emergency supplies in your vehicle.



Include an ice scraper, a small brush or broom, a supply of windshield washer fluid, a rag, some winter outer clothing, a small shovel, a flashlight, a red cloth and a couple of reflective warning triangles. And, if you will be driving under severe conditions, include a small bag of sand, a piece of old carpet or a couple of burlap bags to help provide traction. Be sure you properly secure these items in your vehicle.

Driving On Snow or Ice

Most of the time, those places where your tires meet the road probably have good traction.

However, if there is snow or ice between your tires and the road, you can have a very slippery situation. You will have a lot less traction or “grip” and will need to be very careful.

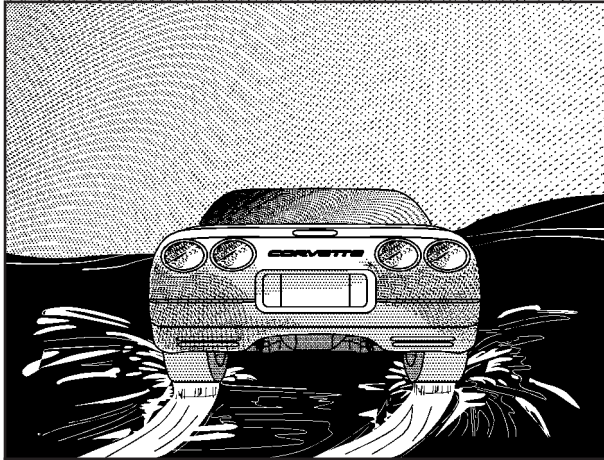

What is the worst time for this? “Wet ice.” Very cold snow or ice can be slick and hard to drive on. But wet ice can be even more trouble because it may offer the least traction of all. You can get wet ice when it is

about freezing (32°F; 0°C) and freezing rain begins to fall. Try to avoid driving on wet ice until salt and sand crews can get there.

Whatever the condition — smooth ice, packed, blowing or loose snow — drive with caution.

Keep your traction control system on. It improves your ability to accelerate when driving on a slippery road. Even though your vehicle has the TCS system, you will want to slow down and adjust your driving to the road conditions. The Active Handling System may also activate. See *Traction Control System (TCS) on page 4-9* and *Active Handling System on page 4-10*.

Your anti-lock brakes improve your vehicle's stability when you make a hard stop on a slippery road. Even though you have the anti-lock braking system, you will want to begin stopping sooner than you would on dry pavement. See *Braking on page 4-6*.

- Allow greater following distance on any slippery road.
- Watch for slippery spots. The road might be fine until you hit a spot that is covered with ice. On an otherwise clear road, ice patches may appear in shaded areas where the sun can not reach: around clumps of trees, behind buildings or under bridges. Sometimes the surface of a curve or an overpass may remain icy when the surrounding roads are clear. If you see a patch of ice ahead of you, brake before you are on it. Try not to brake while you are actually on the ice, and avoid sudden steering maneuvers.

If You Are Caught in a Blizzard

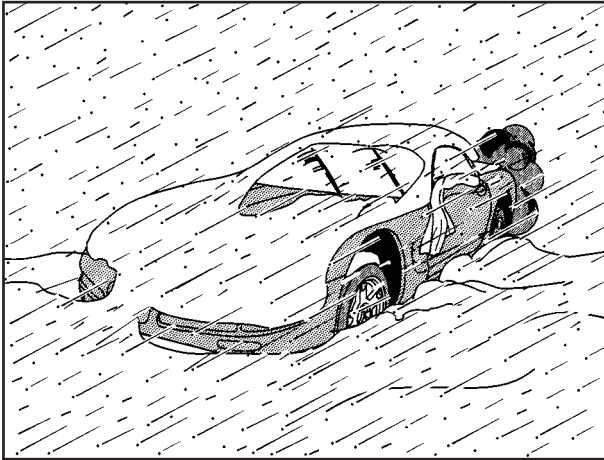

If you are stopped by heavy snow, you could be in a serious situation. You should probably stay with your vehicle unless you know for sure that you are near help and you can hike through the snow. Here are some things to do to summon help and keep yourself and your passengers safe:

- Turn on your hazard flashers.
- Tie a red cloth to your vehicle to alert police that you have been stopped by the snow.

- Put on extra clothing or wrap a blanket around you. If you have no blankets or extra clothing, make body insulators from newspapers, burlap bags, rags, floor mats — anything you can wrap around yourself or tuck under your clothing to keep warm.

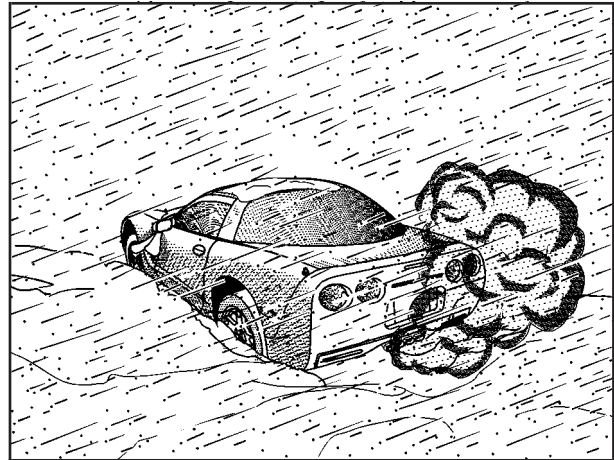

You can run the engine to keep warm, but be careful.

 **CAUTION:**

Snow can trap exhaust gases under your vehicle. This can cause deadly CO (carbon monoxide) gas to get inside. CO could overcome you and kill you. You can not see it or smell it, so you might not know it is in your vehicle. Clear away snow from around the base of your vehicle, especially any that is blocking your exhaust pipe. And check around again from time to time to be sure snow does not collect there.

Open a window just a little on the side of the vehicle that is away from the wind. This will help keep CO out.

Run your engine only as long as you must. This saves fuel. When you run the engine, make it go a little faster than just idle. That is, push the accelerator slightly. This uses less fuel for the heat that you get and it keeps the battery charged. You will need a well-charged battery to restart the vehicle, and possibly for signaling later on with your headlamps. Let the heater run for a while.

Then, shut the engine off and close the window almost all the way to preserve the heat. Start the engine again and repeat this only when you feel really uncomfortable from the cold. But do it as little as possible. Preserve the fuel as long as you can. To help keep warm, you can get out of the vehicle and do some fairly vigorous exercises every half hour or so until help comes.

If You Are Stuck: In Sand, Mud, Ice or Snow

In order to free your vehicle when it is stuck, you will need to spin the wheels, but you do not want to spin your wheels too fast. The method known as “rocking” can help you get out when you are stuck, but you must use caution.

CAUTION:

If you let your tires spin at high speed, they can explode, and you or others could be injured. And, the transmission or other parts of the vehicle can overheat. That could cause an engine compartment fire or other damage. When you are stuck, spin the wheels as little as possible. Do not spin the wheels above 35 mph (55 km/h) as shown on the speedometer.

Notice: Spinning your wheels can destroy parts of your vehicle as well as the tires. If you spin the wheels too fast while shifting your transmission back and forth, you can destroy your transmission.

For information about using tire chains on your vehicle, see *Tire Chains* on page 5-71.

Rocking Your Vehicle To Get It Out

First, turn your steering wheel left and right. That will clear the area around your front wheels. You should turn your TCS System off. See *Traction Control System (TCS)* on page 4-9. Then shift back and forth between REVERSE (R) and a forward gear, spinning the wheels as little as possible. For a manual transmission, shift slowly between either FIRST (1) or SECOND (2) and REVERSE (R), allowing the wheels to stop before shifting into gear. Release the accelerator pedal while you shift, and press lightly on the accelerator pedal when the transmission is in gear. By slowly spinning your wheels in the forward and reverse directions, you will cause a rocking motion that may free your vehicle. If that does not get you out after a few tries, you may need to be towed out. If you do need to be towed out, see *Towing Your Vehicle* on page 4-33.

Towing

Towing Your Vehicle

Consult your dealer or a professional towing service if you need to have your disabled vehicle towed. See *Roadside Assistance Program on page 7-6*.

Recreational Vehicle Towing

Recreational vehicle towing means towing your vehicle behind another vehicle — such as behind a motorhome. The two most common types of recreational vehicle towing are known as “dinghy towing” (towing your vehicle with all four wheels on the ground) and “dolly towing” (towing your vehicle with two wheels on the ground and two wheels up on a device known as a “dolly”).

Your vehicle was not designed to be towed with any of its wheels on the ground. If your vehicle must be towed, see “Towing Your Vehicle” earlier in this section.

Loading Your Vehicle

It is very important to know how much weight your vehicle can carry. This weight is called the vehicle capacity weight and includes the weight of all occupants, cargo and all nonfactory-installed options. Two labels on your vehicle show how much weight it may properly carry, the Tire and Loading Information label and the Certification label.

CAUTION:

Do not load your vehicle any heavier than the GVWR, or either the maximum front or rear GAWR. If you do, parts on your vehicle can break, and it can change the way your vehicle handles. These could cause you to lose control and crash. Also, overloading can shorten the life of your vehicle.

Tire and Loading Information Label

TIRE AND LOADING INFORMATION

SEATING CAPACITY TOTAL FRONT CENTER REAR

The combined weight of occupants and cargo should never exceed XXX kg or XXX lbs.

ORIGINAL TIRE SIZE	COLD TIRE INFLATION PRESSURE		
	FRONT		
	REAR		
	SPARE		

SEE OWNER'S MANUAL FOR ADDITIONAL INFORMATION

Example 1

A. Vehicle Capacity Weight

TIRE-LOADING INFORMATION

OCCUPANTS VEHICLE CAP. WT.

FRT. CTR. RR. TOTAL LBS. KG.

MAX. LOADING & GVWR SAME AS VEHICLE

CAPACITY WEIGHT XXX COLD TIRE

TIRE SIZE SPEED PRESSURE

RTG PSI/KPa

FRT.
RR.
SPA.

IF TIRES ARE HOT, ADD 4PSI/28KPa
SEE OWNER'S MANUAL FOR ADDITIONAL INFORMATION

Example 2

A. Vehicle Capacity Weight

The Tire and Loading Information label shows the seating capacity and the total weight your vehicle can properly carry. This weight is called the vehicle capacity weight. If your vehicle has the Tire and Loading Information label, Example 1, the label is attached to the center pillar, near the driver's door latch. If your vehicle has the Tire-Loading Information label, Example 2, the label is on the rear edge of the driver's door.

The Tire and Loading Information label also gives you the size and recommended inflation pressure for the factory-installed, original equipment tires on your vehicle. For more information on tires and inflation see *Tires on page 5-55 and Inflation - Tire Pressure on page 5-62.*

There is also important loading information on the Certification label. It tells you the Gross Vehicle Weight Rating (GVWR) and the Gross Axle Weight Rating (GAWR) for the front and rear axle; see "Certification Label" later in this section.

Steps for Determining Correct Load Limit

1. Locate the statement "The combined weight of occupants and cargo should never exceed XXX pounds" on your vehicle placard.
2. Determine the combined weight of the driver and passengers that will be riding in your vehicle.
3. Subtract the combined weight of the driver and passengers from XXX kilograms or XXX pounds.
4. The resulting figure equals the available amount of cargo and luggage load capacity. For example, if the "XXX" amount equals 1400 lbs. and there will be five 150 lb. passengers in your vehicle, the amount of available cargo and luggage load capacity is 650 lbs. (1400 – 750 (5 x 150) = 650 lbs).
5. Determine the combined weight of luggage and cargo being loaded on the vehicle. That weight may not safely exceed the available cargo and luggage load capacity calculated in Step 4.
6. If your vehicle will be towing a trailer, the load from your trailer will be transferred to your vehicle. Consult this manual to determine how this reduces the available cargo and luggage load capacity of your vehicle.
Your vehicle is neither designed nor intended to tow a trailer.

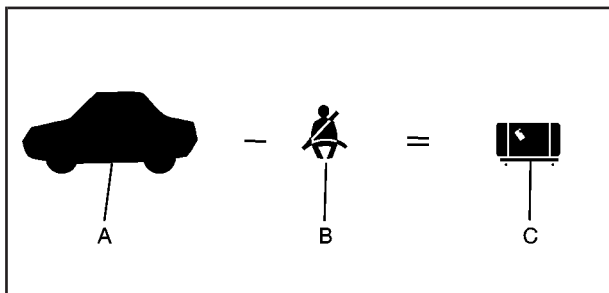

Example 1

Loading Your Vehicle

Item	Description	Total
A	Vehicle Capacity Weight for Example 1 =	400 lbs (181 kg)
B	Subtract Occupant Weight 150 lbs (68 kg) x 1 =	150 lbs (68 kg)
C	Available Occupant and Cargo Weight =	250 lbs (113 kg)

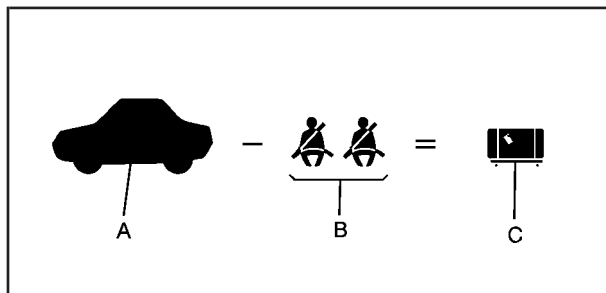

Example 2

Loading Your Vehicle

Item	Description	Total
A	Vehicle Capacity Weight for Example 2 =	400 lbs (181 kg)
B	Subtract Occupant Weight 150 lbs (68 kg) x 2 =	300 lbs (136 kg)
C	Available Cargo Weight =	100 lbs (45 kg)

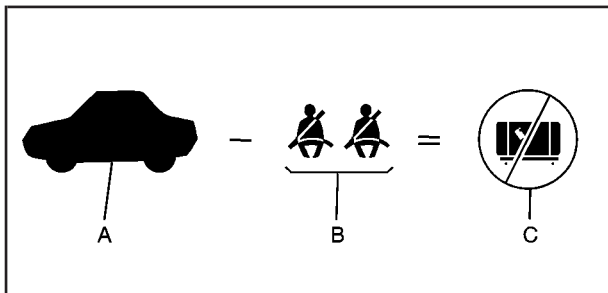

Example 3

Loading Your Vehicle

Item	Description	Total
A	Vehicle Capacity Weight for Example 3 =	400 lbs (181 kg)
B	Subtract Occupant Weight 200 lbs (91 kg) x 2 =	400 lbs (181 kg)
C	Available Cargo Weight =	0 lbs (0 kg)

Refer to your vehicle's tire and loading information label for specific information about your vehicle's capacity weight and seating positions. The combined weight of the driver, passengers and cargo should never exceed your vehicle's capacity weight.

Certification Label

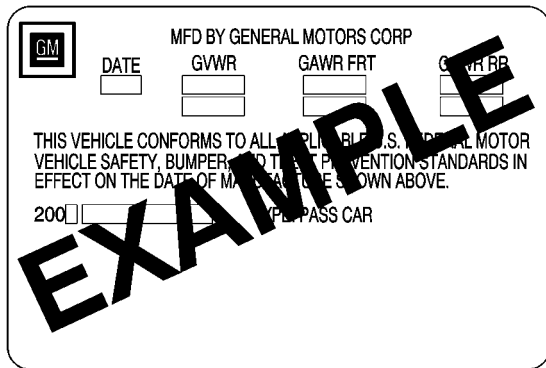

The other label is the Certification label, found on the rear edge of the driver's door. It tells you the gross weight capacity of your vehicle, called the Gross Vehicle Weight Rating (GVWR). The GVWR includes the weight of the vehicle, all occupants, fuel and cargo. Never exceed the GVWR for your vehicle, or the Gross Axle Weight Rating (GAWR) for either the front or rear axle.

And, if you do have a heavy load, you should spread it out. Do not carry more than 100 lbs. (45 kg) in your rear area.

CAUTION:

Do not load your vehicle any heavier than the GVWR, or either the maximum front or rear GAWR. If you do, parts on your vehicle can break, and it can change the way your vehicle handles. These could cause you to lose control and crash. Also, overloading can shorten the life of your vehicle.

Notice: Overloading your vehicle may cause damage. Repairs would not be covered by your warranty. Do not overload your vehicle.

If you put things inside your vehicle – like suitcases, tools, packages or anything else – they will go as fast as the vehicle goes. If you have to stop or turn quickly, or if there is a crash, they will keep going.

CAUTION:

Things you put inside your vehicle can strike and injure people in a sudden stop or turn, or in a crash.

- Put things in the rear area of your vehicle. Try to spread the weight evenly.
- Never stack heavier things, like suitcases, inside the vehicle so that some of them are above the tops of the seats.
- Do not leave an unsecured child restraint in your vehicle.
- When you carry something inside the vehicle, secure it whenever you can.

Towing a Trailer

Your Corvette is neither designed nor intended to tow a trailer.

Section 5 Service and Appearance Care

Service	5-3	Cooling System	5-29
Doing Your Own Service Work	5-3	Power Steering Fluid	5-35
Adding Equipment to the Outside of Your Vehicle	5-4	Windshield Washer Fluid	5-36
Fuel	5-4	Brakes	5-37
Gasoline Octane	5-4	Battery	5-40
Gasoline Specifications	5-5	Jump Starting	5-41
California Fuel	5-5	Rear Axle	5-47
Additives	5-6	Bulb Replacement	5-48
Fuels in Foreign Countries	5-6	Halogen Bulbs	5-48
Filling Your Tank	5-7	Headlamps	5-48
Filling a Portable Fuel Container	5-10	Taillamps and Turn Signal Lamps	5-50
Checking Things Under the Hood	5-10	Back-Up Lamps	5-52
Hood Release	5-11	Windshield Wiper Blade Replacement	5-52
Engine Compartment Overview	5-12	Tires	5-55
Engine Oil	5-13	Extended Mobility Tires (Except Z06)	5-61
Engine Air Cleaner/Filter	5-18	Inflation - Tire Pressure	5-62
Automatic Transmission Fluid	5-20	Tire Pressure Monitor Operation (Except Z06)	5-64
Manual Transmission Fluid	5-21	Tire Rotation	5-65
Hydraulic Clutch	5-22	When It Is Time for New Tires	5-65
Engine Coolant	5-23	Buying New Tires	5-66
Coolant Surge Tank Pressure Cap	5-26	Uniform Tire Quality Grading	5-67
Engine Overheating	5-26	Wheel Alignment and Tire Balance	5-68

Section 5 Service and Appearance Care

Wheel Replacement	5-68	Titanium Exhaust System (Z06 Only)	5-89
Tire Chains	5-71	Fiberglass Springs	5-90
Lifting Your Vehicle	5-71	Chemical Paint Spotting	5-90
If a Tire Goes Flat	5-75	Vehicle Care/Appearance Materials	5-90
Tire Inflator Kit (Z06 Only)	5-77	Vehicle Identification	5-91
Appearance Care	5-82	Vehicle Identification Number (VIN)	5-91
Cleaning the Inside of Your Vehicle	5-83	Service Parts Identification Label	5-92
Care of Safety Belts	5-85	Electrical System	5-92
Weatherstrips	5-85	Add-On Electrical Equipment	5-92
Cleaning the Outside of Your Vehicle	5-85	Headlamp Wiring	5-92
Finish Damage	5-89	Windshield Wiper Fuses	5-92
Carbon Fiber Hood (Z06 Commemorative Edition Model Only)	5-89	Power Windows and Other Power Options	5-92
Magnesium Wheel Finish	5-89	Fuses and Circuit Breakers	5-93
Underbody Maintenance	5-89	Capacities and Specifications	5-99

Service

Your dealer knows your vehicle best and wants you to be happy with it. We hope you will go to your dealer for all your service needs. You will get genuine GM parts and GM-trained and supported service people.

We hope you will want to keep your GM vehicle all GM. Genuine GM parts have one of these marks:

ACDelco

GM Parts

GM
Goodwrench

GM Accessories

Doing Your Own Service Work

If you want to do some of your own service work, you will want to use the proper service manual. It tells you much more about how to service your vehicle than this manual can. To order the proper service manual, see *Service Publications Ordering Information* on page 7-11.

Your vehicle may have an air bag system. If it does, see *Servicing Your Air Bag-Equipped Vehicle* on page 1-49 before attempting to do your own service work.

You should keep a record with all parts receipts and list the mileage and the date of any service work you perform. See *Maintenance Record* on page 6-15.

CAUTION:

You can be injured and your vehicle could be damaged if you try to do service work on a vehicle without knowing enough about it.

- Be sure you have sufficient knowledge, experience, the proper replacement parts and tools before you attempt any vehicle maintenance task.

CAUTION: (Continued)

CAUTION: (Continued)

- **Be sure to use the proper nuts, bolts and other fasteners. “English” and “metric” fasteners can be easily confused. If you use the wrong fasteners, parts can later break or fall off. You could be hurt.**

Adding Equipment to the Outside of Your Vehicle

Things you might add to the outside of your vehicle can affect the airflow around it. This may cause wind noise and affect windshield washer performance. Check with your dealer before adding equipment to the outside of your vehicle.

Fuel

Use of the recommended fuel is an important part of the proper maintenance of your vehicle.

Gasoline Octane

Use premium unleaded gasoline with a posted octane of 91 or higher for best performance. You may also use middle grade or regular unleaded gasoline rated at 87 octane or higher, but your vehicle's acceleration may be slightly reduced. If the octane is less than 87, you may get a heavy knocking noise when you drive. If this occurs, use a gasoline rated at 87 octane or higher as soon as possible. Otherwise, you might damage your engine.

Gasoline Specifications

It is recommended that gasoline meet specifications which were developed by automobile manufacturers around the world and contained in the World-Wide Fuel Charter which is available from the Alliance of Automobile Manufacturers at www.autoalliance.org. Gasoline meeting these specifications could provide improved driveability and emission control system performance compared to other gasoline.



Canada Only

In Canada, look for the “Auto Makers’ Choice” label on the pump.

California Fuel

If your vehicle is certified to meet California Emission Standards (see the underhood emission control label), it is designed to operate on fuels that meet California specifications. If this fuel is not available in states adopting California emissions standards, your vehicle will operate satisfactorily on fuels meeting federal specifications, but emission control system performance may be affected. The malfunction indicator lamp may turn on (see *Malfunction Indicator Lamp on page 3-41*) and your vehicle may fail a smog-check test. If this occurs, return to your authorized GM dealer for diagnosis. If it is determined that the condition is caused by the type of fuel used, repairs may not be covered by your warranty.

Additives

To provide cleaner air, all gasolines in the United States are now required to contain additives that will help prevent engine and fuel system deposits from forming, allowing your emission control system to work properly. You should not have to add anything to your fuel. However, some gasolines contain only the minimum amount of additive required to meet U.S. Environmental Protection Agency regulations. General Motors recommends that you buy gasolines that are advertised to help keep fuel injectors and intake valves clean. If your vehicle experiences problems due to dirty injectors or valves, try a different brand of gasoline.

Gasolines containing oxygenates, such as ethers and ethanol, and reformulated gasolines may be available in your area to contribute to clean air. General Motors recommends that you use these gasolines, particularly if they comply with the specifications described earlier.

Notice: Your vehicle was not designed for fuel that contains methanol. Do not use fuel containing methanol. It can corrode metal parts in your fuel system and also damage the plastic and rubber parts. That damage would not be covered under your warranty.

Some gasolines that are not reformulated for low emissions may contain an octane-enhancing additive called methylcyclopentadienyl manganese tricarbonyl (MMT); ask the attendant where you buy gasoline whether the fuel contains MMT. General Motors does not recommend the use of such gasolines. Fuels containing MMT can reduce the life of spark plugs and the performance of the emission control system may be affected. The malfunction indicator lamp may turn on. If this occurs, return to your authorized GM dealer for service.

Fuels in Foreign Countries

If you plan on driving in another country outside the United States or Canada, the proper fuel may be hard to find. Never use leaded gasoline or any other fuel not recommended in the previous text on fuel. Costly repairs caused by use of improper fuel would not be covered by your warranty.

To check the fuel availability, ask an auto club, or contact a major oil company that does business in the country where you will be driving.

Filling Your Tank

CAUTION:

Fuel vapor burns violently and a fuel fire can cause bad injuries. To help avoid injuries to you and others, read and follow all the instructions on the pump island. Turn off your engine when you are refueling. Do not smoke if you are near fuel or refueling your vehicle. Keep sparks, flames and smoking materials away from fuel. Do not leave the fuel pump unattended when refueling your vehicle — this is against the law in some places. Keep children away from the fuel pump; never let children pump fuel.



The fuel filler door is located on the driver's side of the vehicle. The fuel cap is attached by a tether for your convenience.

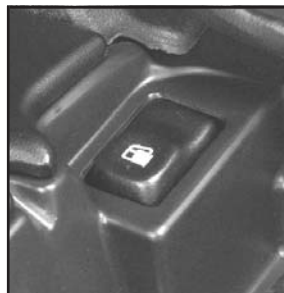

The fuel filler door release button is located inside of the center console storage compartment.



If your fuel filler door release will not operate, there is a manual release tab. The tab is located against the upper trim on the driver's side in the rear compartment. Pull the tab to manually release the fuel filler door.

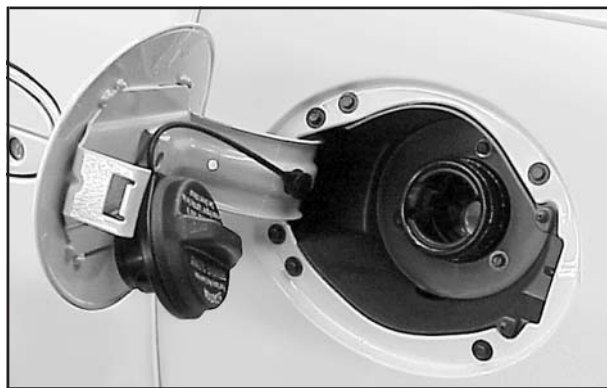

While refueling, rest the tether across the tab on the fuel filler door to prevent damage to your vehicle's finish.

To remove the fuel cap, turn it slowly to the left (counterclockwise). The fuel cap has a spring in it; if you let go of the cap too soon, it will spring back to the right.

 **CAUTION:**

If you spill fuel and then something ignites it, you could be badly burned. Fuel can spray out on you if you open the fuel cap too quickly. This spray can happen if your tank is nearly full, and is more likely in hot weather. Open the fuel cap slowly and wait for any “hiss” noise to stop. Then unscrew the cap all the way.

Be careful not to spill fuel. Do not top off or overfill your tank, and wait a few seconds after you have finished pumping before you remove the nozzle. Clean fuel from painted surfaces as soon as possible. See *Cleaning the Outside of Your Vehicle* on page 5-85.

When you put the fuel cap back on, turn it to the right (clockwise) until you hear a clicking sound. Make sure you fully install the cap. The diagnostic system can determine if the fuel cap has been left off or improperly installed. This would allow fuel to evaporate into the atmosphere. See *Malfunction Indicator Lamp* on page 3-41.

 **CAUTION:**

If a fire starts while you are refueling, do not remove the nozzle. Shut off the flow of fuel by shutting off the pump or by notifying the station attendant. Leave the area immediately.

Notice: If you need a new fuel cap, be sure to get the right type. Your dealer can get one for you. If you get the wrong type, it may not fit properly. This may cause your malfunction indicator lamp to light and may damage your fuel tank and emissions system. See *Malfunction Indicator Lamp* on page 3-41.

Filling a Portable Fuel Container

CAUTION:

Never fill a portable fuel container while it is in your vehicle. Static electricity discharge from the container can ignite the gasoline vapor. You can be badly burned and your vehicle damaged if this occurs. To help avoid injury to you and others:

- Dispense gasoline only into approved containers.
- Do not fill a container while it is inside a vehicle, in a vehicle's trunk, pickup bed or on any surface other than the ground.
- Bring the fill nozzle in contact with the inside of the fill opening before operating the nozzle. Contact should be maintained until the filling is complete.
- Do not smoke while pumping gasoline.

Checking Things Under the Hood

CAUTION:

An electric fan under the hood can start up and injure you even when the engine is not running. Keep hands, clothing and tools away from any underhood electric fan.

CAUTION:

Things that burn can get on hot engine parts and start a fire. These include liquids like fuel, oil, coolant, brake fluid, windshield washer and other fluids, and plastic or rubber. You or others could be burned. Be careful not to drop or spill things that will burn onto a hot engine.

Hood Release

Notice: If the hood comes into contact with the headlamp doors when you raise the hood, you could damage the hood and/or the headlamp doors. Always close the headlamp doors before opening the hood.

To open the hood, do the following:



1. Pull the handle located inside the vehicle below the instrument panel on the driver's side.



2. Go to the side of the vehicle and pull up on the rear edge of the hood, near the windshield.

Before closing the hood, be sure all the filler caps are on properly. Then, just pull the hood down and close it firmly.

Engine Compartment Overview

When you open the hood, you will see the following:

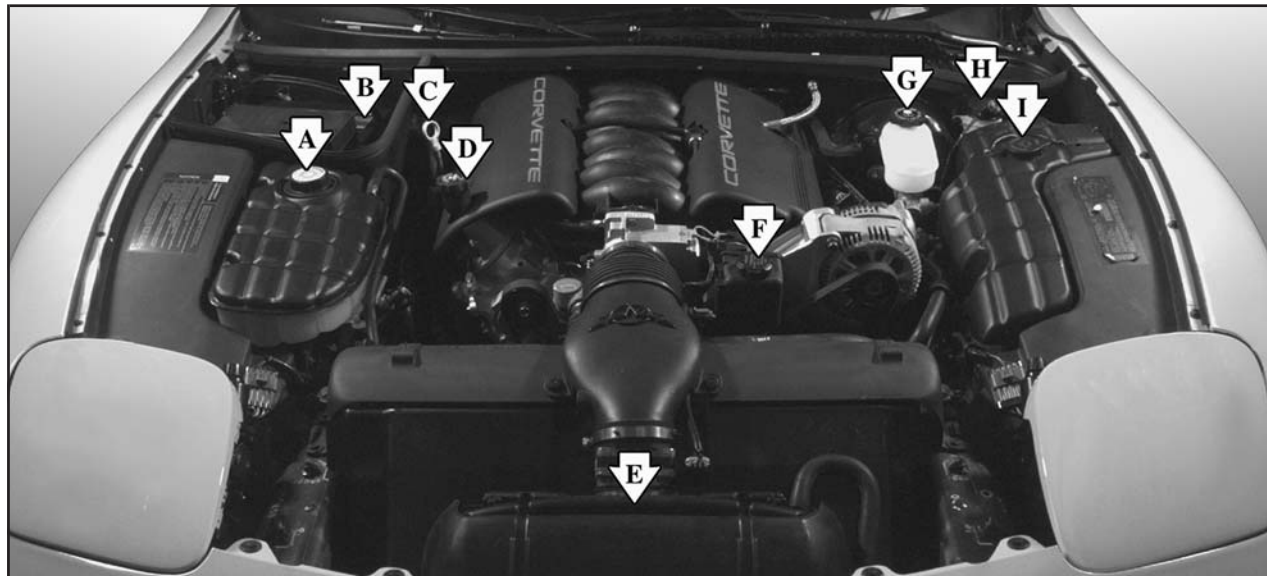

- A. Coolant Surge Tank and Pressure Cap. See *Engine Coolant* on page 5-23.
- B. Battery. See *Battery* on page 5-40.
- C. Engine Oil Dipstick. See *Engine Oil* on page 5-13.
- D. Engine Oil Fill Cap. See *Engine Oil* on page 5-13.
- E. Engine Air Cleaner/Filter. See *Engine Air Cleaner/Filter* on page 5-18.
- F. Power Steering Fluid Reservoir. See *Power Steering Fluid* on page 5-35.
- G. Brake Fluid Reservoir. See *Brakes* on page 5-37.
- H. Clutch Master Cylinder Reservoir. See *Hydraulic Clutch* on page 5-22.
- I. Windshield Washer Fluid Reservoir. See *Windshield Washer Fluid* on page 5-36.

Engine Oil

If the LOW OIL LEVEL message on the Driver Information Center comes on, it means you need to check your engine oil level right away. For more information, see *Driver Information Center (DIC)* on page 3-48.

You should check your engine oil level regularly; this is an added reminder.

Checking Engine Oil

It is a good idea to check your engine oil level every time you get fuel. In order to get an accurate reading, the oil must be warm and the vehicle must be on level ground.

The engine oil dipstick handle is a yellow loop. See *Engine Compartment Overview* on page 5-12 for the location of the engine oil dipstick.

Turn off the engine and give the oil a few minutes to drain back into the oil pan. If you don't, the oil dipstick might not show the actual level.

Pull out the dipstick and clean it with a paper towel or a cloth, then push it back in all the way. Remove it again, keeping the tip down.

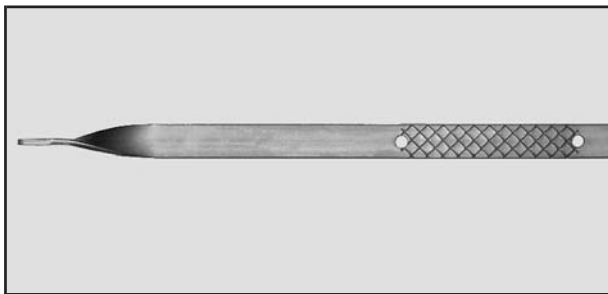

See *Engine Compartment Overview* on page 5-12 for the location of the engine oil fill cap.

When to Add Engine Oil

If the oil is below the cross-hatched area at the tip of the dipstick, you will need to add at least one quart of oil. But you must use the right kind. This section explains what kind of oil to use. For engine oil crankcase capacity, see *Capacities and Specifications* on page 5-99.

See “*Racing or Other Competitive Driving*” under *Starting Your Engine* on page 2-21 for additional information on engine oil.

Notice: Do not add too much oil. If your engine has so much oil that the oil level gets above the cross-hatched area that shows the proper operating range, your engine could be damaged.

Be sure to add enough oil to put the level somewhere in the proper operating range. Push the dipstick all the way back in when you are through.

What Kind of Engine Oil to Use

Look for two things:

- GM4718M
Your vehicle's engine requires a special oil meeting GM Standard GM4718M. Oils meeting this standard may be identified as synthetic. However, not all *synthetic* oils will meet this GM standard. You should look for and use only an oil that meets GM Standard GM4718M.

Notice: If you use oils that do not have the GM4718M Standard designation, you can cause engine damage not covered by your warranty.

RECOMMENDED SAE VISCOSITY GRADE ENGINE OILS

**HOT
WEATHER**

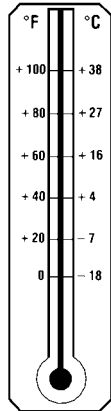

**COLD
WEATHER**

LOOK
FOR THIS
SYMBOL
AND GM STANDARD
GM4718M



SAE 5W-30
RECOMMENDED

SAE 10W-30
ACCEPTABLE
IF 5W-30 IS NOT
AVAILABLE

DO NOT USE SAE 10W-40, SAE 20W-50 OR ANY OTHER
VISCOSITY GRADE OIL NOT RECOMMENDED

- SAE 5W-30

As shown in the viscosity chart, SAE 5W-30 is best for your vehicle. However, you can use SAE 10W-30 if it is going to be 0°F (-18°C) or above.

These numbers on an oil container show its viscosity, or thickness. Do not use other viscosity oils such as SAE 20W-50.

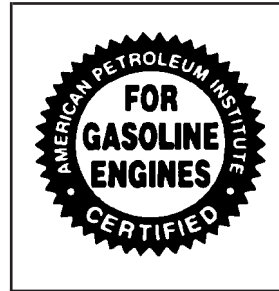

Oils meeting these requirements should also have the starburst symbol on the container. This symbol indicates that the oil has been certified by the American Petroleum Institute (API).

You should look for this on the oil container, and use *only* those oils that are identified as meeting GM Standard GM4718M and have the starburst symbol on the front of the oil container.

Your vehicle's engine is filled at the factory with a Mobil 1[®] synthetic oil, which meets all requirements for your vehicle.

Substitute Engine Oil: When adding oil to maintain engine oil level, oil meeting GM Standard GM4718M may not be available. You can add substitute oil designated SAE 5W-30 with the starburst symbol at all temperatures. If temperatures are above 0°F (-18°C), you may substitute SAE 10W-30 with the starburst symbol. Substitute oil not meeting GM Standard GM4718M should not be used for an oil change.

Engine Oil Additives

Do not add anything to your oil. The recommended oils with the starburst symbol that meet GM Standard GM4718M are all you will need for good performance and engine protection.

When to Change Engine Oil (GM Oil Life System)

Your vehicle has a computer that lets you know when to change your engine oil and filter. This is based on engine revolutions and engine temperature, and not on mileage. Based on driving conditions, the mileage at which an oil change will be indicated can vary considerably. For the oil life system to work properly, you must reset the system every time the oil is changed.

When the system has calculated that oil life has been diminished, it will indicate that an oil change is necessary. A CHANGE OIL SOON message will come on. Change your oil as soon as possible within the next two times you stop for fuel. It is possible that, if you are driving under the best conditions, the oil life system may not indicate that an oil change is necessary for over a year. However, your engine oil and filter must be changed at least once a year and at this time the system must be reset. Your dealer has GM-trained service people who will perform this work using genuine GM parts and reset the system. It is also important to check your oil regularly and keep it at the proper level.

If the system is ever reset accidentally, you must change your oil at 3,000 miles (5 000 km) since your last oil change. Remember to reset the oil life system whenever the oil is changed.

How to Reset the CHANGE OIL SOON Message

The GM Oil Life System calculates when to change your engine oil and filter based on vehicle use. Anytime your oil is changed, reset the system so it can calculate when the next oil change is required. If a situation occurs where you change your oil prior to a CHANGE OIL SOON message being turned on, reset the system.

To reset the CHANGE OIL SOON message after an oil change, do the following:

1. Turn the ignition to ON, with the engine off.
2. Press the TRIP button so the OIL LIFE percentage is displayed.
3. Press RESET and hold for two seconds. OIL LIFE REMAIN 100% will appear.
4. Turn the key to OFF.

If the CHANGE OIL SOON message comes back on when you start your vehicle, the engine oil life system has not reset. Repeat the procedure.

What to Do with Used Oil

Used engine oil contains certain elements that may be unhealthy for your skin and could even cause cancer. Do not let used oil stay on your skin for very long. Clean your skin and nails with soap and water, or a good hand cleaner. Wash or properly dispose of clothing or rags containing used engine oil. See the manufacturer's warnings about the use and disposal of oil products.

Used oil can be a threat to the environment. If you change your own oil, be sure to drain all the oil from the filter before disposal. Never dispose of oil by putting it in the trash, pouring it on the ground, into sewers, or into streams or bodies of water. Instead, recycle it by taking it to a place that collects used oil. If you have a problem properly disposing of your used oil, ask your dealer, a service station or a local recycling center for help.

Engine Air Cleaner/Filter

See *Engine Compartment Overview* on page 5-12 for location of the engine air cleaner/filter.



When to Inspect the Engine Air Cleaner/Filter

Inspect the air cleaner/filter at every oil change and replace at the first oil change after 25,000 miles (40 000 km).

How to Inspect the Engine Air Cleaner/Filter

To inspect the air cleaner/filter, remove the filter from the vehicle and lightly shake the filter to release loose dust and dirt. If the filter remains caked with dirt, a new filter is required.

To inspect or replace the filter, do the following:

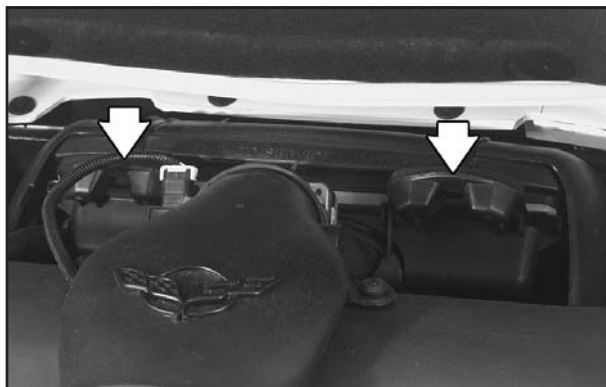

1. Pull up on the clips on each side to release the assembly.



2. Pull the assembly out.
3. Replace the filter. See *Normal Maintenance Replacement Parts* on page 6-13.
4. Push the assembly back into place.
5. Fasten the clips.

⚠ CAUTION:

Operating the engine with the air cleaner/filter off can cause you or others to be burned. The air cleaner not only cleans the air, it helps to stop flame if the engine backfires. If it is not there and the engine backfires, you could be burned. Do not drive with it off, and be careful working on the engine with the air cleaner/filter off.

Notice: If the air cleaner/filter is off, a backfire can cause a damaging engine fire. And, dirt can easily get into your engine, which will damage it. Always have the air cleaner/filter in place when you are driving.

Automatic Transmission Fluid

How to Check

It is not necessary to check the transmission fluid level. A transmission fluid leak is the only reason for fluid loss. If a leak occurs, take the vehicle to your dealer service department and have it repaired as soon as possible.

There is a special procedure for checking and changing the transmission fluid. Because this procedure is difficult, you should have this done at your dealer service department. Contact your dealer for additional information or the procedure can be found in the service manual. To purchase a service manual, see *Service Publications Ordering Information on page 7-11*.

Notice: We recommend you use only fluid labeled DEXRON®-III, because fluid with that label is made especially for your automatic transmission. Damage caused by fluid other than DEXRON®-III is not covered by your new vehicle warranty.

Change both the fluid and filter every 50,000 miles (80 000 km) if the vehicle is mainly driven under one of these conditions:

- In heavy city traffic where the outside temperature regularly reaches 90°F (32°C) or higher.
- In hilly or mountainous terrain.
- High performance operation.

If you do not use your vehicle under one of these conditions, change the fluid and filter every 100,000 miles (166 000 km).

See *Scheduled Maintenance on page 6-4* for the proper service intervals for the transmission fluid and filter.

Manual Transmission Fluid

When to Check

A good time to have it checked is when the engine oil is changed. However, the fluid in your manual transmission doesn't require changing.

How to Check

Because this operation can be difficult, you may choose to have this done at your dealership service department.

If you do it yourself, be sure to follow all the instructions here, or you could get a false reading.

Notice: Too much or too little fluid can damage your transmission. Too much can mean that some of the fluid could come out and fall on hot engine part or exhaust system parts, starting a fire. Too little fluid could cause the transmission to overheat. Be sure to get an accurate reading if you check your transmission fluid.

Check the fluid level only when your engine is off, the vehicle is parked on a level place and the transmission is cool enough for you to rest your fingers on the transmission case.

Then, follow these steps:

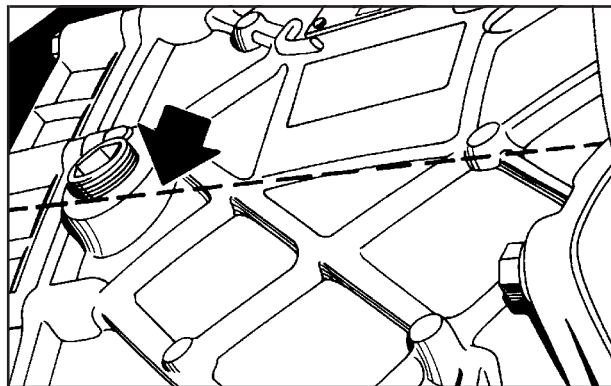

1. Remove the filler plug.
2. Check that the lubricant level is up to the bottom of the filler plug hole.
3. If the fluid level is good, install the plug and be sure it is fully seated. If the fluid level is low, add more fluid as described in the next steps.

How to Add Fluid

Here's how to add fluid. Refer to the Maintenance Schedule to determine what kind of fluid to use. See *Recommended Fluids and Lubricants on page 6-11*.

1. Remove the filler plug.
2. Add fluid at the filler plug hole. Add only enough fluid to bring the fluid level up to the bottom of the filler plug hole.
3. Install the filler plug. Be sure the plug is fully seated.
4. Tighten the plug to 20 lb ft (27 N•m).

Hydraulic Clutch

The hydraulic clutch linkage in your vehicle is self-adjusting. The master cylinder reservoir is filled with hydraulic fluid.

It is not necessary to regularly check the fluid unless you suspect there is a leak in the system. Adding fluid won't correct a leak.

A fluid loss in this system could indicate a problem. Have the system inspected and repaired.

When to Check and What to Use



The clutch master cylinder reservoir is located at the rear of the engine compartment on the driver's side. See *Engine Compartment Overview on page 5-12* for more information on location.

Refer to the Maintenance Schedule to determine how often you should check the fluid level in your master cylinder reservoir and for the proper fluid. See *Owner Checks and Services on page 6-8* and *Recommended Fluids and Lubricants on page 6-11*.

How to Check and Add Fluid



Fluid should be added if the fluid level is below the step on the inside of the reservoir. There are additional instructions on the reservoir cap. Put the rubber seal and cap back on. See *Engine Compartment Overview* on page 5-12 for more information on location.

Engine Coolant

The cooling system in your vehicle is filled with DEX-COOL[®] engine coolant. This coolant is designed to remain in your vehicle for 5 years or 150,000 miles (240 000 km), whichever occurs first, if you add only DEX-COOL[®] extended life coolant.

The following explains your cooling system and how to add coolant when it is low. If you have a problem with engine overheating, see *Engine Overheating* on page 5-26.

A 50/50 mixture of clean, drinkable water and DEX-COOL[®] coolant will:

- Give freezing protection down to -34°F (-37°C).
- Give boiling protection up to 265°F (129°C).
- Protect against rust and corrosion.
- Help keep the proper engine temperature.
- Let the warning lights and gages work as they should.

Notice: Using coolant other than DEX-COOL[®] may cause premature engine, heater core or radiator corrosion. In addition, the engine coolant may require changing sooner, at 30,000 miles (50 000 km) or 24 months, whichever occurs first. Any repairs would not be covered by your warranty. Always use DEX-COOL[®](silicate-free) coolant in your vehicle.

What to Use

Use a mixture of one-half *clean, drinkable water* and one-half DEX-COOL[®] coolant which will not damage aluminum parts. If you use this coolant mixture, you do not need to add anything else.

CAUTION:

Adding only plain water to your cooling system can be dangerous. Plain water, or some other liquid such as alcohol, can boil before the proper coolant mixture will. Your vehicle's coolant warning system is set for the proper coolant mixture. With plain water or the wrong mixture, your engine could get too hot but you would not get the overheat warning. Your engine could catch fire and you or others could be burned. Use a 50/50 mixture of clean, drinkable water and DEX-COOL[®] coolant.

Notice: If you use an improper coolant mixture, your engine could overheat and be badly damaged. The repair cost would not be covered by your warranty. Too much water in the mixture can freeze and crack the engine, radiator, heater core and other parts.

If you have to add coolant more than four times a year, have your dealer check your cooling system.

Notice: If you use the proper coolant, you do not have to add extra inhibitors or additives which claim to improve the system. These can be harmful.

Checking Coolant



The coolant surge tank is located in the engine compartment behind the passenger's side headlamp. See *Engine Compartment Overview* on page 5-12 for more information on location.

 **CAUTION:**

Turning the surge tank pressure cap when the engine and radiator are hot can allow steam and scalding liquids to blow out and burn you badly. Never turn the surge tank pressure cap — even a little — when the engine and radiator are hot.

The vehicle must be on a level surface. When your engine is cold, the coolant level should be at the FULL COLD mark. The FULL COLD mark is on the front of the coolant surge tank. Do not overfill the surge tank. Too much coolant can result in an overflow when the fluid is hot.

Adding Coolant

If you need more coolant, add the proper DEX-COOL[®] coolant mixture *at the surge tank*, but only when the engine is cool.

 **CAUTION:**

You can be burned if you spill coolant on hot engine parts. Coolant contains ethylene glycol, and it will burn if the engine parts are hot enough. Do not spill coolant on a hot engine.

When replacing the pressure cap, make sure it is hand-tight.

Coolant Surge Tank Pressure Cap

Notice: If the pressure cap is not tightly installed, coolant loss and possible engine damage may occur. Be sure the cap is properly and tightly secured.

See *Engine Compartment Overview* on page 5-12 for information on location.

Engine Overheating

You will find an engine coolant temperature gage on the instrument panel cluster and a COOLANT OVER TEMP message on the Driver Information Center (DIC). See *Engine Coolant Temperature Gage* on page 3-41 and *DIC Warnings and Messages* on page 3-58.

Overheated Engine Protection Operating Mode

If an overheated engine condition exists and the messages COOLANT OVER TEMP and REDUCED ENGINE POWER are displayed, along with the Check Engine light, an overheat protection mode which alternates firing groups of cylinders helps prevent engine damage. In this mode, you will notice a loss in power and engine performance. This operating mode allows your vehicle to be driven to a safe place in an emergency; you may drive up to 50 miles (80 km).

Notice: After driving in the overheated engine protection operating mode, to avoid engine damage, allow the engine to cool before attempting any repair. The engine oil will be severely degraded. Repair the cause of coolant loss, change the oil and reset the oil life system. See *Engine Oil* on page 5-13.

If Steam Is Coming From Your Engine



CAUTION:

Steam from an overheated engine can burn you badly, even if you just open the hood. Stay away from the engine if you see or hear steam coming from it. Just turn it off and get

CAUTION: (Continued)

CAUTION: (Continued)

everyone away from the vehicle until it cools down. Wait until there is no sign of steam or coolant before you open the hood.

If you keep driving when your engine is overheated, the liquids in it can catch fire. You or others could be badly burned. Stop your engine if it overheats, and get out of the vehicle until the engine is cool.

See “Overheated Engine Protection Operating Mode” under *Engine Overheating on page 5-26* for information on driving to a safe place in an emergency.

Notice: If your engine catches fire because you keep driving with no coolant, your vehicle can be badly damaged. The costly repairs would not be covered by your warranty. See “Overheated Engine Protection Operating Mode” under *Engine Overheating on page 5-26* for information on driving to a safe place in an emergency.

If No Steam Is Coming From Your Engine

If you get an engine overheat warning but see or hear no steam, the problem may not be too serious. Sometimes the engine can get a little too hot when you:

- Climb a long hill on a hot day.
- Stop after high-speed driving.
- Idle for long periods in traffic.

If you get the overheat warning with no sign of steam, try this for a minute or so:

1. In heavy traffic, let the engine idle in NEUTRAL (N) while stopped. If it is safe to do so, pull off the road, shift to PARK (P) or NEUTRAL (N) and let the engine idle.
2. Turn on your heater to full hot at the highest fan speed and open the window as necessary.

If you no longer have the overheat warning, you can drive. Just to be safe, drive slower for about 10 minutes. If the warning does not come back on, you can drive normally.

If the warning continues and you are not stopped, pull over, stop, and park your vehicle right away.

If there is still no sign of steam, you can idle the engine for three minutes while you are parked. If you still have the warning, *turn off the engine and get everyone out of the vehicle* until it cools down. Also, see “Overheated Engine Protection Operating Mode” listed previously in this section.

You may decide not to lift the hood but to get service help right away.

Cooling System

When you decide it is safe to lift the hood, here is what you will see:

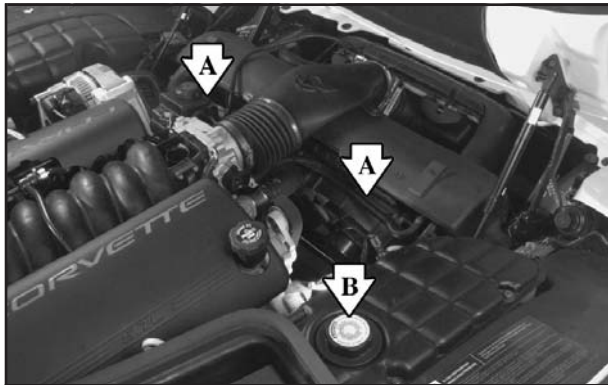

- A. Electric Engine Cooling Fans
- B. Coolant Surge Tank

CAUTION:

An electric engine cooling fan under the hood can start up even when the engine is not running and can injure you. Keep hands, clothing and tools away from any underhood electric fan.

If the coolant inside the coolant surge tank is boiling, do not do anything else until it cools down. The vehicle should be parked on a level surface.



The coolant level should be at or above the FULL COLD mark. If it is not, you may have a leak at the pressure cap or in the radiator hoses, heater hoses, radiator, water pump or somewhere else in the cooling system.

⚠ CAUTION:

Heater and radiator hoses, and other engine parts, can be very hot. Do not touch them. If you do, you can be burned.

CAUTION: (Continued)

CAUTION: (Continued)

Do not run the engine if there is a leak. If you run the engine, it could lose all coolant. That could cause an engine fire, and you could be burned. Get any leak fixed before you drive the vehicle.

If there seems to be no leak, with the engine on, check to see if the electric engine cooling fans are running. If the engine is overheating, both fans should be running. If they are not, your vehicle needs service.

Notice: Engine damage from running your engine without coolant is not covered by your warranty. See “Overheated Engine Protection Operating Mode” in the Index for information on driving to a safe place in an emergency.

Notice: Using coolant other than DEX-COOL[®] may cause premature engine, heater core or radiator corrosion. In addition, the engine coolant may require changing sooner, at 30,000 miles (50 000 km) or 24 months, whichever occurs first. Any repairs would not be covered by your warranty. Always use DEX-COOL[®] (silicate-free) coolant in your vehicle.

How to Add Coolant to the Coolant Surge Tank

If you have not found a problem yet, check to see if coolant is visible in the surge tank. If coolant is visible but the coolant level is not at the FULL COLD mark on the coolant surge tank, add a 50/50 mixture of *clean, drinkable water* and DEX-COOL[®] coolant at the coolant surge tank, but be sure the cooling system, including the coolant surge tank pressure cap, is cool before you do it. See *Engine Coolant on page 5-23* for more information.

If no coolant is visible in the surge tank, add coolant as follows:

CAUTION:

Steam and scalding liquids from a hot cooling system can blow out and burn you badly. They are under pressure, and if you turn the coolant surge tank pressure cap — even a little — they can come out at high speed.

CAUTION: (Continued)

CAUTION: (Continued)

Never turn the cap when the cooling system, including the coolant surge tank pressure cap, is hot. Wait for the cooling system and coolant surge tank pressure cap to cool if you ever have to turn the pressure cap.



 **CAUTION:**

Adding only plain water to your cooling system can be dangerous. Plain water, or some other liquid such as alcohol, can boil before the proper coolant mixture will. Your vehicle's coolant warning system is set for the proper coolant mixture. With plain water or the wrong mixture, your engine could get too hot but you would not get the overheat warning. Your engine could catch fire and you or others could be burned. Use a 50/50 mixture of clean, drinkable water and DEX-COOL[®] coolant.

Notice: In cold weather, water can freeze and crack the engine, radiator, heater core and other parts. Use the recommended coolant and the proper coolant mixture.

 **CAUTION:**

You can be burned if you spill coolant on hot engine parts. Coolant contains ethylene glycol and it will burn if the engine parts are hot enough. Do not spill coolant on a hot engine.



1. Park the vehicle on a level surface. You can remove the coolant surge tank pressure cap when the cooling system, including the coolant surge tank pressure cap and upper radiator hose, is no longer hot. Turn the pressure cap slowly counterclockwise about one-quarter turn and then stop.

If you hear a hiss, wait for that to stop. A hiss means there is still some pressure left.

2. Then keep turning the pressure cap slowly, and remove it.



3. Then fill the coolant surge tank with the proper mixture, to the FULL COLD mark on the coolant surge tank.

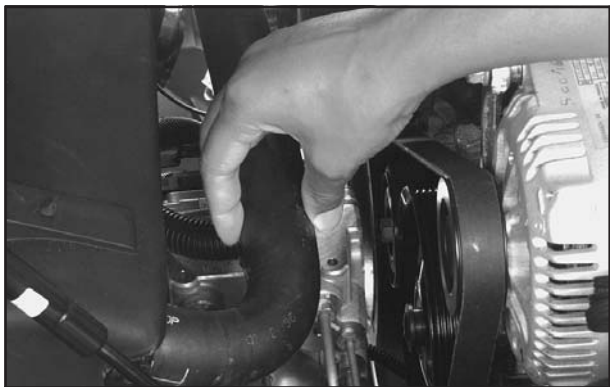

4. With the coolant surge tank pressure cap off, start the engine and let it run until you can feel the upper radiator hose getting hot. Watch out for the engine cooling fan(s).

By this time, the coolant level inside the coolant surge tank may be lower. If the level is lower, add more of the proper mixture to the coolant surge tank until the level reaches the FULL COLD mark on the coolant surge tank.

5. Then replace the pressure cap. Be sure the pressure cap is hand-tight and fully seated.

Power Steering Fluid

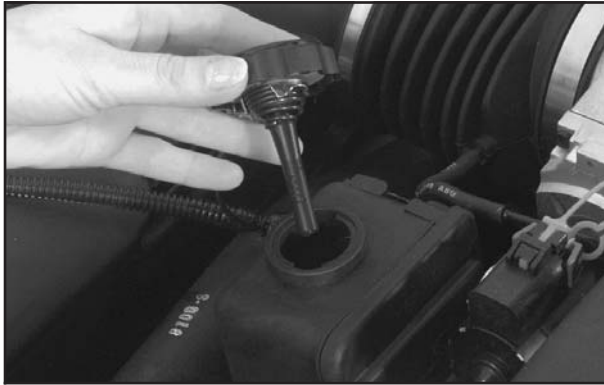

When to Check Power Steering Fluid

It is not necessary to regularly check power steering fluid unless you suspect there is a leak in the system or you hear an unusual noise. A fluid loss in this system could indicate a problem. Have the system inspected and repaired. See *Engine Compartment Overview* on page 5-12 for reservoir location.

How to Check Power Steering Fluid

Turn the key off, let the engine compartment cool down, wipe the cap and the top of the reservoir clean, then unscrew the cap and wipe the dipstick with a clean rag. Replace the cap and completely tighten it. Then remove the cap again and look at the fluid level on the dipstick. There are markings on both sides of the dipstick.

The level should be at the FULL COLD mark. If necessary, add only enough fluid to bring the level up to the mark.

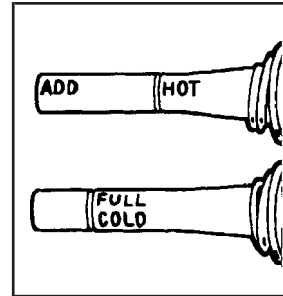

- When the engine compartment is hot, the level should be at the HOT mark.
- When the engine compartment is cool, the level should be at the FULL COLD mark.

What to Use

To determine what kind of fluid to use, see *Recommended Fluids and Lubricants* on page 6-11. Always use the proper fluid. Failure to use the proper fluid can cause leaks and damage hoses and seals.

Windshield Washer Fluid

What to Use

When you need windshield washer fluid, be sure to read the manufacturer's instructions before use. If you will be operating your vehicle in an area where the temperature may fall below freezing, use a fluid that has sufficient protection against freezing.

Adding Washer Fluid

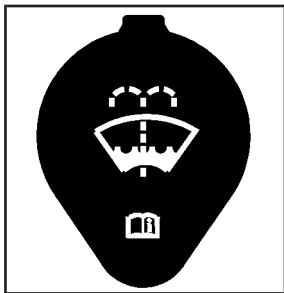

Open the cap with the washer symbol on it. See *Engine Compartment Overview* on page 5-12 for reservoir location. Add washer fluid until the tank is full.

Notice:

- When using concentrated washer fluid, follow the manufacturer's instructions for adding water.
- Do not mix water with ready-to-use washer fluid. Water can cause the solution to freeze and damage your washer fluid tank and other parts of the washer system. Also, water does not clean as well as washer fluid.
- Fill your washer fluid tank only three-quarters full when it is very cold. This allows for expansion if freezing occurs, which could damage the tank if it is completely full.
- Do not use engine coolant (antifreeze) in your windshield washer. It can damage your washer system and paint.

Brakes

Brake Fluid



Your brake master cylinder reservoir is filled with DOT-3 brake fluid. See *Engine Compartment Overview* on page 5-12 for the location of the reservoir.

There are only two reasons why the brake fluid level in the reservoir might go down. The first is that the brake fluid goes down to an acceptable level during normal brake lining wear. When new linings are put in, the fluid level goes back up. The other reason is that fluid is

leaking out of the brake system. If it is, you should have your brake system fixed, since a leak means that sooner or later your brakes will not work well, or will not work at all.

So, it is not a good idea to “top off” your brake fluid. Adding brake fluid will not correct a leak. If you add fluid when your linings are worn, then you will have too much fluid when you get new brake linings. You should add (or remove) brake fluid, as necessary, only when work is done on the brake hydraulic system.

CAUTION:

If you have too much brake fluid, it can spill on the engine. The fluid will burn if the engine is hot enough. You or others could be burned, and your vehicle could be damaged. Add brake fluid only when work is done on the brake hydraulic system. See “Checking Brake Fluid” in this section.

Refer to the Maintenance Schedule to determine when to check your brake fluid. See *Scheduled Maintenance* on page 6-4.

Checking Brake Fluid

You can check the brake fluid without taking off the cap. Just look at the brake fluid reservoir. The fluid level should be above the MIN mark on the reservoir. If it is not, have your brake system checked to see if there is a leak.

After work is done on the brake hydraulic system, make sure the level is between the MIN and MAX marks.

What to Add

When you do need brake fluid, use only DOT-3 brake fluid. Refer to *Recommended Fluids and Lubricants on page 6-11*. Use new brake fluid from a sealed container only.

Always clean the brake fluid reservoir cap and the area around the cap before removing it. This will help keep dirt from entering the reservoir.

CAUTION:

With the wrong kind of fluid in your brake system, your brakes may not work well, or they may not even work at all. This could cause a crash. Always use the proper brake fluid.

Notice:

- **Using the wrong fluid can badly damage brake system parts. For example, just a few drops of mineral-based oil, such as engine oil, in your brake system can damage brake system parts so badly that they will have to be replaced. Do not let someone put in the wrong kind of fluid.**
- **If you spill brake fluid on your vehicle's painted surfaces, the paint finish can be damaged. Be careful not to spill brake fluid on your vehicle. If you do, wash it off immediately. See *Appearance Care on page 5-82*.**

Brake Wear

Your vehicle has four-wheel disc brakes.

Disc brake pads have built-in wear indicators that make a high-pitched warning sound when the brake pads are worn and new pads are needed. The sound may come and go or be heard all the time your vehicle is moving (except when you are pushing on the brake pedal firmly).

CAUTION:

The brake wear warning sound means that soon your brakes will not work well. That could lead to an accident. When you hear the brake wear warning sound, have your vehicle serviced.

Z06 models are equipped with high performance front brake linings designed for improved brake performance under severe use. They will normally exhibit some low speed noise and you may notice an increase in the amount of brake dust.

Notice: Continuing to drive with worn-out brake pads could result in costly brake repair.

Some driving conditions or climates may cause a brake squeal when the brakes are first applied or lightly applied. This does not mean something is wrong with your brakes.

Brake linings should always be replaced as complete axle sets.

Brake Pedal Travel

See your dealer if the brake pedal does not return to normal height, or if there is a rapid increase in pedal travel. This could be a sign of brake trouble.

Brake Adjustment

As you make brake stops, your disc brakes automatically adjust for wear.

Replacing Brake System Parts

The braking system on a vehicle is complex. Its many parts have to be of top quality and work well together if the vehicle is to have really good braking. Your vehicle was designed and tested with top-quality GM brake parts. When you replace parts of your braking system — for example, when your brake linings wear down and you need new ones put in — be sure you get new approved GM replacement parts. If you do not, your brakes may no longer work properly. For example, if someone puts in brake linings that are wrong for your vehicle, the balance between your front and rear brakes can change — for the worse. The braking performance you have come to expect can change in many other ways if someone puts in the wrong replacement brake parts.

Battery

Your new vehicle comes with a maintenance free ACDelco® battery. When it is time for a new battery, get one that has the replacement number shown on the original battery's label. We recommend an ACDelco® battery.

For battery replacement, see your dealer or the service manual. To purchase a service manual, see *Service and Owner Publications in Service Publications Ordering Information on page 7-11*.

Warning: Battery posts, terminals and related accessories contain lead and lead compounds, chemicals known to the State of California to cause cancer and reproductive harm. Wash hands after handling.

Vehicle Storage

If you are not going to drive your vehicle for 25 days or more, remove the black, negative (-) cable from the battery. This will help keep your battery from running down.

CAUTION:

Batteries have acid that can burn you and gas that can explode. You can be badly hurt if you are not careful. See *Jump Starting on page 5-41* for tips on working around a battery without getting hurt.

Contact your dealer to learn how to prepare your vehicle for longer storage periods.

Also, for your audio system, see *Theft-Deterrent Feature on page 3-86*.

Jump Starting

If your battery has run down, you may want to use another vehicle and some jumper cables to start your vehicle. Be sure to follow the steps below to do it safely.

CAUTION:

Batteries can hurt you. They can be dangerous because:

- They contain acid that can burn you.
- They contain gas that can explode or ignite.
- They contain enough electricity to burn you.

If you do not follow these steps exactly, some or all of these things can hurt you.

Notice: If you try to start your vehicle by pushing or pulling it, you could damage your vehicle. Do not push or pull your vehicle to start it; instead, use the jump starting procedure in this manual to start your vehicle when the battery has run down.

1. Check the other vehicle. It must have a 12-volt battery with a negative ground system.

Notice: If the other vehicle's system is not a 12-volt system with a negative ground, both vehicles can be damaged. Only use vehicles with 12-volt systems with negative grounds to jump start your vehicle.

2. Get the vehicles close enough so the jumper cables can reach, but be sure the vehicles are not touching each other. If they are, it could cause a ground connection you do not want. You would not be able to start your vehicle, and the bad grounding could damage the electrical systems.

To avoid the possibility of the vehicles rolling, set the parking brake firmly on both vehicles involved in the jump start procedure. Put an automatic transmission in PARK (P) or a manual transmission in NEUTRAL before setting the parking brakes.

Notice: If you leave your radio or other accessories on during the jump starting procedure, they could be damaged. The repairs would not be covered by your warranty. Always turn off your radio and other accessories when jump starting your vehicle.

3. Turn off the ignition on both vehicles. Unplug unnecessary accessories plugged into the cigarette lighter or in the accessory power outlet. Turn off the radio and all lamps that are not needed. This will avoid sparks and help save both batteries. And it could save your radio!
4. Open the hoods and locate the batteries. Find the positive (+) and negative (-) terminal locations on each vehicle. See *Engine Compartment Overview on page 5-12* for more information on location.

 **CAUTION:**

An electric fan can start up even when the engine is not running and can injure you. Keep hands, clothing and tools away from any underhood electric fan.

 **CAUTION:**

Using a match near a battery can cause battery gas to explode. People have been hurt doing this, and some have been blinded. Use a flashlight if you need more light.

Be sure the battery has enough water. You do not need to add water to the ACDelco® battery installed in your new vehicle. But if a battery has filler caps, be sure the right amount of fluid is there. If it is low, add water to take care of that first. If you do not, explosive gas could be present.

Battery fluid contains acid that can burn you. Do not get it on you. If you accidentally get it in your eyes or on your skin, flush the place with water and get medical help immediately.

 **CAUTION:**

Fans or other moving engine parts can injure you badly. Keep your hands away from moving parts once the engine is running.

5. Check that the jumper cables do not have loose or missing insulation. If they do, you could get a shock. The vehicles could be damaged, too.

Before you connect the cables, here are some basic things you should know. Positive (+) will go to positive (+) or to a remote positive (+) terminal if the vehicle has one. Negative (-) will go to a heavy, unpainted metal engine part or to a remote negative (-) terminal if the vehicle has one.

Do not connect positive (+) to negative (-) or you will get a short that would damage the battery and maybe other parts, too. And do not connect the negative (-) cable to the negative (-) terminal on the dead battery because this can cause sparks.

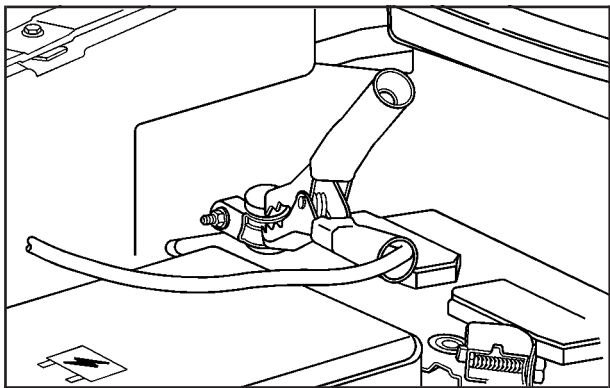

6. Connect the red positive (+) cable to the positive (+) terminal of the dead battery. Use a remote positive (+) terminal if the vehicle has one.



7. Do not let the other end touch metal. Connect it to the positive (+) terminal of the good battery. Use a remote positive (+) terminal if the vehicle has one.



8. Now connect the black negative (-) cable to the negative (-) terminal of the good battery. Use a remote negative (-) terminal if the vehicle has one.

Do not let the other end touch anything until the next step. The other end of the negative (-) cable does not go to the dead battery. It goes to a heavy, unpainted metal engine part or to a remote negative (-) terminal on the vehicle with the dead battery.

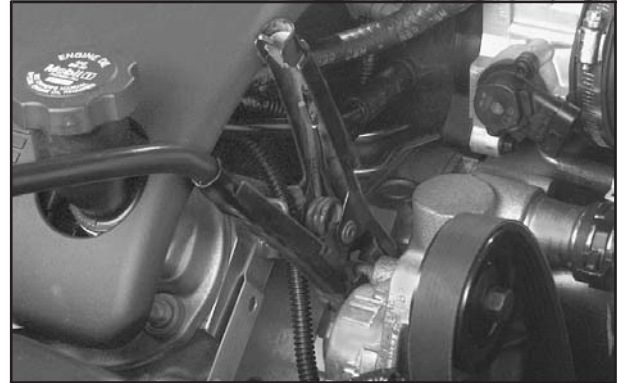

9. Connect the other end of the negative (-) cable at least 18 inches (45 cm) away from the dead battery, but not near engine parts that move. The electrical connection is just as good there, and the chance of sparks getting back to the battery is much less.
10. Now start the vehicle with the good battery and run the engine for a while.
11. Try to start the vehicle that had the dead battery. If it will not start after a few tries, it probably needs service.

Notice: If the jumper cables are removed in the wrong order, electrical shorting may occur and damage the vehicle. The repairs would not be covered by your warranty. Remove the jumper cables in the correct order, making sure that the cables do not touch each other or other metal.

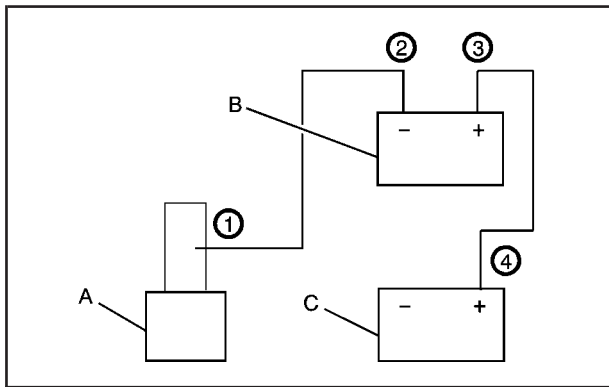

Jumper Cable Removal

- A. Heavy, Unpainted Metal Engine Part
- B. Good Battery
- C. Dead Battery

To disconnect the jumper cables from both vehicles, do the following:

1. Disconnect the black negative (-) cable from the vehicle that had the dead battery.
2. Disconnect the black negative (-) cable from the vehicle with the good battery.
3. Disconnect the red positive (+) cable from the vehicle with the good battery.
4. Disconnect the red positive (+) cable from the other vehicle.

Rear Axle

When to Check Lubricant

It is not necessary to regularly check rear axle fluid unless you suspect there is a leak or you hear an unusual noise. A fluid loss could indicate a problem. Have it inspected and repaired.

How to Check Lubricant

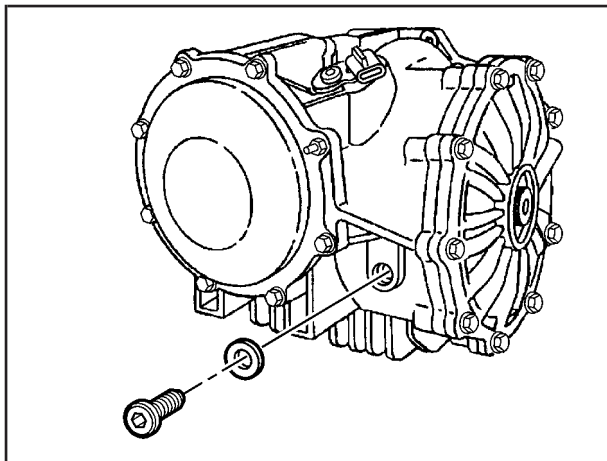

To get an accurate reading, the vehicle should be on a level surface.

If the level is below the bottom of the filler plug hole, you will need to add some lubricant. Add enough lubricant to raise the level to the bottom of the filler plug hole.

What to Use

To add lubricant when the level is low, use SAE 75W-90 Synthetic Gear Lubricant (GM Part No. 12378261) or equivalent meeting GM Specification 9986115. To completely refill after draining, add 4 ounces (118 ml) of Limited-Slip Differential Lubricant Additive (GM Part No. 1052358) or equivalent. Then fill to the bottom of the filler plug hole with the Synthetic Gear Lubricant.

Bulb Replacement

For the proper type of replacement bulb, see *Bulb Replacement on page 5-48*.

For any bulb changing procedure not listed in this section, contact your dealer's service department.

Halogen Bulbs

CAUTION:

Halogen bulbs have pressurized gas inside and can burst if you drop or scratch the bulb. You or others could be injured. Be sure to read and follow the instructions on the bulb package.

Headlamps

1. The headlamp doors need to be halfway open. Turn the headlamps on, then quickly back to the parking lamps setting. You may have to do this a few times to get the half-open position.



You can also open the headlamp doors manually by turning the adjuster counterclockwise.



2. Remove the screws on each side of the headlamp bezel.
3. Open the hood.
4. To remove the bezel, pull the sides slightly outward and tilt the bezel forward. Pull the clip centered above the lens outward. Be careful not to scratch the paint on the vehicle.



5. Reach behind the lamp and turn the bulb counterclockwise to remove it. Don't touch the halogen bulbs. The inner bulb is the high beam and the outer bulb is the low beam.
6. Disconnect the desired bulb from the wiring harness.
7. Reverse the steps listed previously with a new bulb.

Taillamps and Turn Signal Lamps

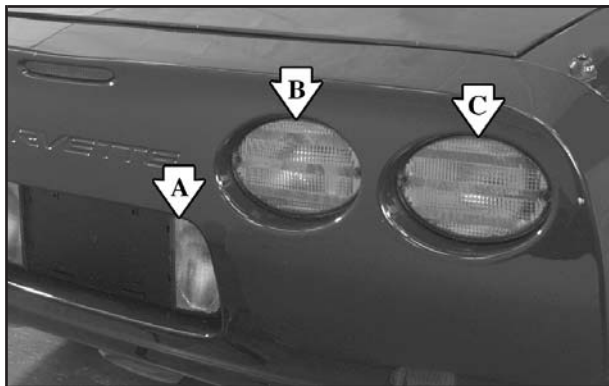

- A. Back-Up Lamp
- B. Inboard Taillamp
- C. Outboard Taillamp



1. Remove the screws.
2. Pull the taillamp housing assembly out.



3. To remove the socket with the bulb, squeeze the tab while you turn the socket counterclockwise.



4. Remove the bulb from the socket.
5. Reverse the steps listed previously with a new bulb.

Back-Up Lamps

You can access the back-up lamps through the inboard taillamp opening. See *Taillamps and Turn Signal Lamps* on page 5-50.

1. Squeeze the tab on the socket while turning it counterclockwise to remove it from the assembly.
2. Remove the bulb from the socket.
3. Reverse the steps listed previously with a new bulb.

Replacement Bulbs

Exterior Lamp	Bulb Number
High-Beam Headlamp	9005
Low-Beam Headlamp	9006
Back-Up	2057
Rear Stop/Tail and Turn Signal	3057
For any bulb replacements or procedures not listed here, please consult your dealer.	

Windshield Wiper Blade Replacement

Windshield wiper blades should be inspected each time maintenance is performed. See "Wiper Blade Check" under *Scheduled Maintenance* on page 6-4 for more information.

Replacement blades come in different types and are removed in different ways. For the proper type and length, see *Normal Maintenance Replacement Parts* on page 6-13.

It is a good idea to clean or replace the wiper blade assembly every six months.

Notice: Allowing the wiper blade arm to touch the windshield when no wiper blade is installed could damage the windshield. Any damage that occurs would not be covered by your warranty. Do not allow the wiper blade arm to touch the windshield.

To remove the wiper blade assembly, do the following:

1. Open the hood to gain access to the windshield wipers.
2. Lift the wiper arm until it locks into a vertical position.

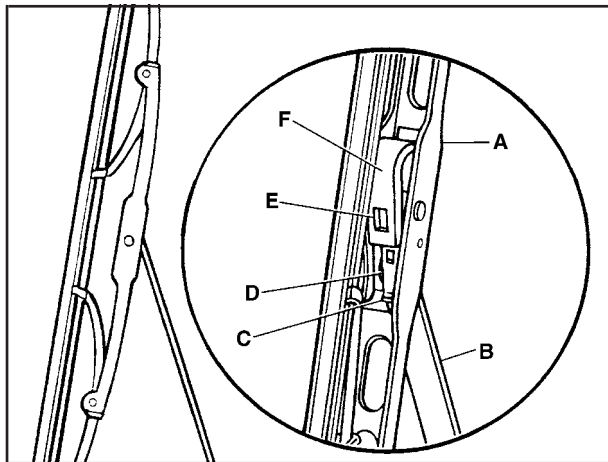

- A. Blade Assembly
- B. Arm Assembly
- C. Locking Tab

- D. Blade Pivot
- E. Hook Slot
- F. Arm Hook

3. Press down on the blade assembly pivot locking tab (C). Pull down on the blade assembly (A) to release it from the wiper arm hook (F).
4. Remove the insert from the blade assembly (A). The insert has two notches at one end that are locked by the bottom claws of the blade assembly. At the notch end, pull the insert from the blade assembly.

To install the new wiper insert:

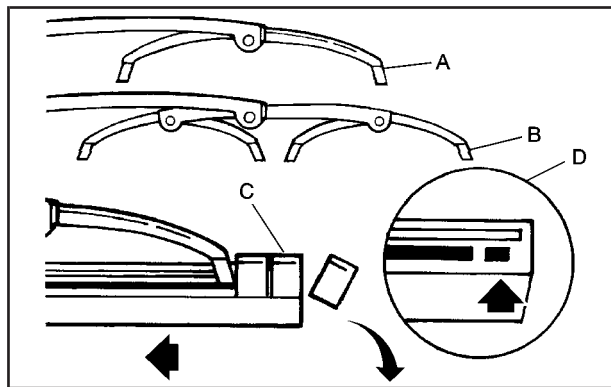

1. Slide the insert (D), notched end last, into the end with the two blade claws (A). Slide the insert all the way through the blade claws at the opposite end (B). Plastic caps (C) will be forced off as the insert is fully installed.
2. Be sure the notches are locked by the bottom claws. Make sure that all other claws are properly locked on both sides of the insert slots.

3. Put the blade assembly pivot in the wiper arm hook. Pull up until the pivot locking tab locks in the hook slot.
4. Carefully lower the wiper arm and blade assembly onto the windshield.

Installation guide:

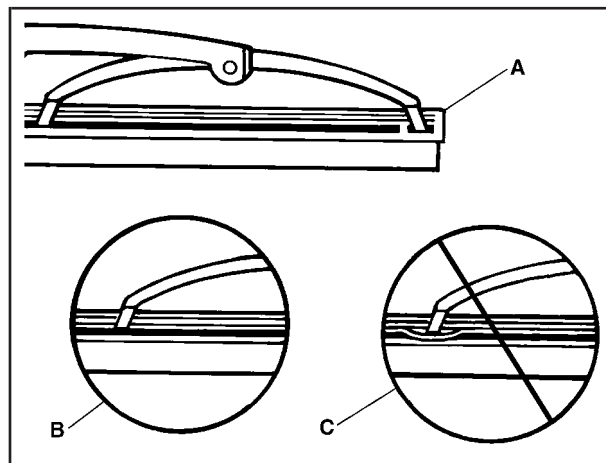

- A. Claw in Notch
B. Correct Installation
C. Incorrect Installation

Tires

Your new vehicle comes with high-quality tires made by a leading tire manufacturer. If you ever have questions about your tire warranty and where to obtain service, see your GM Warranty booklet for details. For additional information refer to the tire manufacturer's booklet included with your vehicle's Owner's Manual.

CAUTION:

Poorly maintained and improperly used tires are dangerous.

- **Overloading your tires can cause overheating as a result of too much friction. You could have an air-out and a serious accident. See “Loading Your Vehicle” in the Index.**

CAUTION: (Continued)

CAUTION: (Continued)

- **Underinflated tires pose the same danger as overloaded tires. The resulting accident could cause serious injury. Check all tires frequently to maintain the recommended pressure. Tire pressure should be checked when your tires are cold.**
- **Overinflated tires are more likely to be cut, punctured or broken by a sudden impact — such as when you hit a pothole. Keep tires at the recommended pressure.**
- **Worn, old tires can cause accidents. If your tread is badly worn, or if your tires have been damaged, replace them.**

Tire Sidewall Labeling

Useful information about a tire is molded into its sidewall. The following illustration shows an example of a passenger car tire sidewall.

(D) Tire Identification Number (TIN): The letters and numbers following DOT code are the Tire Identification Number (TIN). The TIN shows the manufacturer and plant code, tire size, and date the tire was manufactured. The TIN is molded onto both sides of the tire, although only one side may have the date of manufacture.

(E) Tire Ply Material: The type of cord and number of plies in the sidewall and under the tread.

(F) Uniform Tire Quality Grading (UTQG): Tire manufacturers are required to grade tires based on three performance factors: treadwear, traction and temperature resistance. For more information see *Uniform Tire Quality Grading on page 5-67*.

(G) Maximum Cold Inflation Load Limit: Maximum load that can be carried and the maximum pressure needed to support that load. For more information on recommended tire pressure see *Inflation - Tire Pressure on page 5-62* and *Loading Your Vehicle on page 4-33*.

Tire Size Codes

The following illustration shows an example of a typical passenger car tire size.

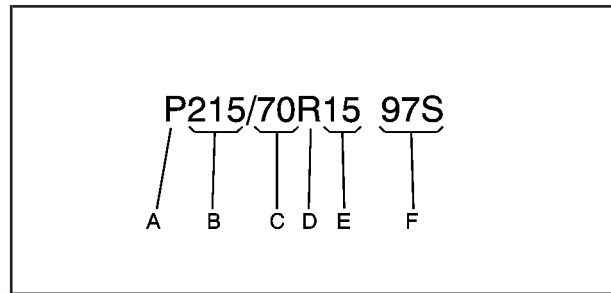

- | | |
|------------------|------------------------|
| A. P-Metric Tire | D. Construction Code |
| B. Tire Width | E. Rim Diameter |
| C. Aspect Ratio | F. Service Description |

(A) P-Metric Tire: The United States version of a metric tire sizing system. The letter “P” as the first character in the tire size means a passenger vehicle tire engineered to standards set by the U. S. Tire and Rim Association.

(B) Tire Width: The three-digit number indicates the tire section width in millimeters from sidewall to sidewall.

(C) Aspect Ratio: A two-digit number that indicates the tire height-to-width measurements. For example, if the tire size aspect ratio is “70,” as shown in item “C” of the illustration, it would mean that the tire’s sidewall is 70% as high as it is wide.

(D) Construction Code: A letter code is used to indicate the type of ply construction in the tire. The letter “R” means radial ply construction; the letter “D” means diagonal or bias ply construction; and the letter “B” means belted-bias ply construction.

(E) Rim Diameter: Diameter of the wheel in inches.

(F) Service Description: These characters represent the load range and the speed rating of a tire. The load range represents the load carrying capacity a tire is certified to carry. The load index can range from 1 to 279. The speed rating is the maximum speed a tire is certified to carry a load. Speed ratings range from “A” to “Z”.

Tire Terminology and Definitions

Air Pressure: The amount of air inside the tire pressing outward on each square inch of the tire. Air pressure is expressed in pounds per square inch (psi) or kilopascal (kPa).

Accessory Weight: This means the combined weight of optional accessories. Some examples of optional accessories are, automatic transmission, power steering, power brakes, power windows, power seats, and air conditioning.

Aspect Ratio: The relationship of a tire’s height to its width.

Belt: A rubber coated layer of cords that is located between the plies and the tread. Cords may be made from steel or other reinforcing materials.

Bead: The tire bead contains steel wires wrapped by steel cords that hold the tire onto the rim.

Bias Ply Tire: A pneumatic tire in which the plies are laid at alternate angles less than 90 degrees to the centerline of the tread.

Cold Inflation Pressure: The amount of air pressure in a tire, measured in pounds per square inch (psi) before a tire has built up heat from driving.
See Inflation - Tire Pressure on page 5-62.

Curb Weight: This means the weight of a motor vehicle with standard and optional equipment including the maximum capacity of fuel, oil and coolant, but without passengers and cargo.

DOT Markings: A code molded into the sidewall of a tire signifying that the tire is in compliance with the U.S. Department of Transportation motor vehicle safety standards. The DOT code includes the Tire Identification Number (TIN), an alphanumeric designator which can also identify the tire manufacturer, production plant, brand and date of production.

GVWR: Gross Vehicle Weight Rating, see *Loading Your Vehicle on page 4-33*.

GAWR FRT: Gross Axle Weight Rating for the front axle, see *Loading Your Vehicle on page 4-33*.

GAWR RR: Gross Axle Weight Rating for the rear axle, see *Loading Your Vehicle on page 4-33*.

Intended Outboard Sidewall: The side of an asymmetrical tire that must always face outward when mounted on a vehicle.

Kilopascal (kPa): The metric unit for air pressure. There are 6.9 kPa's to one psi.

Light Truck (LT-Metric) Tire: A tire used on light duty trucks and some multipurpose passenger vehicles.

Load Index: An assigned number ranging from 1 to 279 that corresponds to the load carrying capacity of a tire.

Maximum Inflation Pressure: The maximum air pressure to which a cold tire may be inflated. The maximum air pressure is molded onto the sidewall.

Maximum Load Rating: The load rating for a tire at the maximum permissible inflation pressure for that tire.

Maximum Loaded Vehicle Weight: The sum of curb weight; accessory weight; vehicle capacity weight; and production options weight.

Normal Occupant Weight: The number of occupants a vehicle is designed to seat multiplied by 150 pounds (68 kg). See *Loading Your Vehicle on page 4-33*.

Occupant Distribution: Designated seating positions.

Outward Facing Sidewall: The side of a asymmetrical tire that has a particular side that faces outward when mounted on a vehicle. The side of the tire that contains a whitewall, bears white lettering or bears manufacturer, brand and or model name molding that is higher or deeper than the same moldings on the other sidewall of the tire.

Passenger (P-Metric) Tire: A tire used on passenger cars and some light duty trucks and multipurpose vehicles.

Recommended Inflation Pressure: Vehicle manufacturer's recommended tire inflation pressure and shown on the tire placard. See *Inflation - Tire Pressure on page 5-62* and *Loading Your Vehicle on page 4-33*.

Radial Ply tire: A pneumatic tire in which the ply cords that extend to the beads are laid at 90 degrees to the centerline of the tread.

Rim: A metal support for a tire and upon which the tire beads are seated.

Sidewall: The portion of a tire between the tread and the bead.

Speed Rating: An alphanumeric code assigned to a tire indicating the maximum speed at which a tire can operate.

Traction: The friction between the tire and the road surface. The amount of grip provided.

Tread: The portion of a tire that comes into contact with the road.

Treadwear Indicators: Narrow bands, sometimes called "wear bars," that show across the tread of a tire when only 2/32 inch of tread remains. See *When It Is Time for New Tires on page 5-65*.

UTQGS: Uniform Tire Quality Grading Standards, a tire information system that provides consumers with ratings for a tire's traction, temperature and treadwear. Ratings are determined by tire manufacturers using government testing procedures. The ratings are molded into the sidewall of the tire. See *Uniform Tire Quality Grading on page 5-67*.

Vehicle Capacity Weight: The number of designated seating positions multiplied by 150 lbs. (68 kg) plus the rated cargo load. See *Loading Your Vehicle on page 4-33*.

Vehicle Maximum Load on the Tire: Load on an individual tire due to curb weight, accessory weight, occupant weight and cargo weight.

Vehicle Placard: A label permanently attached to a vehicle showing the original equipment tire size and recommended inflation pressure. See *Loading Your Vehicle on page 4-33*.

Extended Mobility Tires (Except Z06)

Your vehicle, when new, had Goodyear Extended Mobility Tires (EMT). There's no spare tire, no tire changing equipment and no place to store a tire in the vehicle. Extended Mobility Tires perform so well without any air that a Tire Pressure Monitor (TPM) is used to alert you if a tire has lost pressure.

If a tire goes flat, you won't need to stop on the side of the road to change the tire. You can just keep on driving. The shorter the distance you drive and the slower the speed, the greater the chance that the tire will not have to be replaced. If you drive on a deflated EMT for 50 miles (80 km) or less and at speeds of 55 mph (90 km/h) or less, there is a good chance that the tire can be repaired. The tire can operate effectively with no air pressure for up to 200 miles (320 km) at speeds up to 55 mph (90 km/h), but the tire would then have to be replaced. When a tire is filled with air, it provides a cushion between the road and the wheel. Because you won't have this cushion when driving on a deflated tire, try to avoid potholes that could damage your wheel and require replacement of it.

Some road hazards can damage a tire beyond repair. This damage could occur even before you've driven on the tire in a deflated condition. When a tire has been damaged, or if you've driven any distance on a deflated EMT, check with an authorized Goodyear EMT Service

Center to determine whether the tire can be repaired or should be replaced. To maintain your vehicle's extended mobility feature, all replacement tires must be Extended Mobility Tires. As soon as possible, contact the nearest authorized GM or Goodyear EMT servicing facility for inspection and repair or replacement. To locate the nearest GM or Goodyear EMT servicing facility, call Roadside Assistance. For phone numbers and Roadside Assistance details see *Roadside Assistance Program on page 7-6*. You may also contact Goodyear, for the nearest authorized EMT servicing facility, by calling 1-800-789-9878.

CAUTION:

Extended mobility tires are constructed differently than other tires and could explode during improper service. You or others could be injured or killed if you attempt to repair, replace, dismount, or mount a extended mobility tire. Let only an authorized EMT Service Center repair, replace, dismount and mount extended mobility tires.

The valve stems on your extended mobility tires have sensors that are part of the Tire Pressure Monitor (TPM). See *Tire Pressure Monitor Operation (Except Z06) on page 5-64*. The TPM sensors contain batteries which are designed to last for 10 years under normal driving conditions. See your dealer if you ever need to have a wheel replaced, or if the sensors ever need replacement.

Notice: Using liquid sealants can damage the tire valves and tire pressure monitor sensors in your extended mobility tires. This damage would not be covered by warranty. Don't use liquid sealants in your extended mobility tires.

If you feel that winter tires are needed for your driving conditions, Goodyear Eagle M+S EMT tires are available in your original equipment sizes from an authorized Goodyear EMT retailer. These tires will improve snow traction while maintaining your vehicle's extended mobility feature. When using winter tires on your vehicle, be sure to use them on all four wheels. See *Buying New Tires on page 5-66*.

Inflation - Tire Pressure

The tire and loading information label, shows the correct inflation pressures for your tires when they're cold. "Cold" means your vehicle has been sitting for at least three hours or driven no more than 1 mile (1.6 km). See *Loading Your Vehicle on page 4-33*, for the location of your vehicle's tire and loading information label.

Notice: Don't let anyone tell you that underinflation or overinflation is all right. It's not. If your tires don't have enough air (underinflation), you can get the following:

- Too much flexing
- Too much heat
- Tire overloading
- Bad wear
- Bad handling
- Bad fuel economy

If your tires have too much air (overinflation), you can get the following:

- Unusual wear
- Bad handling
- Rough ride
- Needless damage from road hazards

When to Check

Check your tires once a month or more.

How to Check

Use a good quality pocket-type gage to check tire pressure. You can't tell if your tires are properly inflated simply by looking at them. Radial tires may look properly inflated even when they are underinflated.

Remove the valve cap from the tire valve stem. Press the tire gage firmly onto the valve to get a pressure measurement. If the cold tire inflation pressure matches the recommended pressure on the tire and loading information label, no further adjustment is necessary. If the inflation pressure is low, add air until you reach the recommended amount.

If you overfill the tire, release air by pushing on the metal stem in the center of the tire valve. Recheck the tire pressure with the tire gage.

Be sure to put the valve caps back on the valve stems. They help prevent leaks by keeping out dirt and moisture.

If your vehicle is equipped with the Tire Pressure Monitor, you can check tire inflation pressures while driving. After you've reached a speed of 15 mph (24 kmh) or more, press and release the GAGES button on the Driver Information Center (DIC) until the front tire pressures are displayed. Then, press and release the GAGES button for the rear tire pressures. If the display doesn't show tire pressure, or if the SERVICE TIRE MON SYS message appears see your dealer for service. For more information, see *Tire Pressure Monitor Operation (Except Z06)* on page 5-64 and *Driver Information Center (DIC)* on page 3-48.

Tire Pressure Monitor Operation (Except Z06)

The Tire Pressure Monitor (TPM) has a sensor on each road wheel that transmits to a receiver on the instrument panel.

The system operates on a radio frequency subject to Federal Communications Commission (FCC) Rules and with Industry and Science Canada.

This device complies with Part 15 of the FCC Rules. Operation is subject to the following two conditions: (1) this device may not cause harmful interference, and (2) this device must accept any interference received, including interference that may cause undesired operation.

This device complies with RSS-210 of Industry and Science Canada. Operation is subject to the following two conditions: (1) this device may not cause interference, and (2) this device must accept any interference received, including interference that may cause undesired operation of the device.

Changes or modifications to this system by other than an authorized service facility could void authorization to use this equipment.

If a tire's inflation pressure is between 5 psi (35 kPa) and 25 psi (170 kPa), you will see a message on the Driver Information Center. This message will show which tire is underinflated and two chimes will sound. An example would be LOW TIRE PRESSURE-LR. This would mean that the inflation pressure in your left rear tire is between 5 psi (35 kPa) and 25 psi (170 kPa). If the inflation pressure in the tire drops below 5 psi (35 kPa), the message would read FLAT TIRE-LR and four chimes will sound. See *Driver Information Center (DIC) on page 3-48*.

The TPM will also alert you if a tire's pressure is higher than 42 psi (290 kPa). The message will show which tire is overinflated and two chimes will sound. An example would be HIGH PRESSURE-LR. This would mean that the inflation pressure in your left rear tire is higher than 42 psi (290 kPa). See *Driver Information Center (DIC) on page 3-48*.

If a tire pressure message appears on the Driver Information Center, stop as soon as you can. Have the tire pressures checked and set to those shown on your Tire-Loading Information label. See *Inflation - Tire Pressure* on page 5-62.

⚠ CAUTION:

When the **LOW TIRE PRESSURE** or **FLAT TIRE** message is displayed on the Driver Information Center, your vehicle's handling capabilities will be reduced during severe maneuvers. If you drive too fast, you could lose control of your vehicle. You or others could be injured. Don't drive over 55 mph (90 km/h) when the **LOW TIRE PRESSURE** or **FLAT TIRE** message is displayed. Drive cautiously, and check your tire pressures as soon as you can.

Tire Rotation

The tires on your vehicle are different sizes front to rear. Due to this, your tires should not be rotated. Each tire and wheel should be used only in the position it is in.

When It Is Time for New Tires

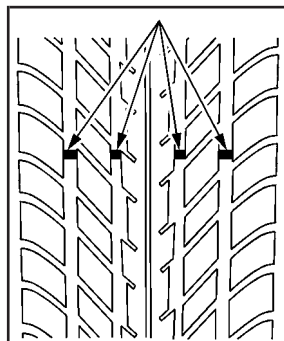

One way to tell when it's time for new tires is to check the treadwear indicators, which will appear when your tires have only 1/16 inch (1.6 mm) or less of tread remaining.

You need a new tire if any of the following statements are true:

- You can see the indicators at three or more places around the tire.
- You can see cord or fabric showing through the tire's rubber.
- The tread or sidewall is cracked, cut or snagged deep enough to show cord or fabric.
- The tire has a bump, bulge or split.
- The tire has a puncture, cut or other damage that can't be repaired well because of the size or location of the damage.

Buying New Tires

To find out what kind and size of tires your vehicle needs, look at the Tire and Loading Information label. See *Loading Your Vehicle on page 4-33*, for an example of the label and where it is located on your vehicle.

The tires installed on your vehicle when it was new had a Tire Performance Criteria Specification (TPC Spec) number on each tire's sidewall. When you get new tires, GM recommends that you get tires with that same TPC Spec number. That way your vehicle will continue to have tires that are designed to give proper endurance, handling, load range, speed rating, traction, ride, tire pressure monitoring system performance and other things during normal service on your vehicle. If your tires have an all-season tread design, the TPC number will be followed by an "MS" (for mud and snow).

If you ever replace your tires with those not having a TPC Spec number, make sure they are the same size, load range, speed rating and construction type (bias, bias-belted or radial) as your original tires.

CAUTION:

Mixing tires could cause you to lose control while driving. If you mix tires of different sizes (other than those originally installed on your vehicle) or types (radial and bias-belted tires), the vehicle may not handle properly, and you could have a crash. Using tires of different sizes (other than those originally installed on your vehicle) may also cause damage to your vehicle. Be sure to use the correct size and type tires on all four wheels.

If your vehicle is equipped with Extended Mobility Tires and you feel that winter tires are needed, see *Extended Mobility Tires (Except Z06) on page 5-61*.

CAUTION:

If you use bias-ply tires on your vehicle, the wheel rim flanges could develop cracks after many miles of driving. A tire and/or wheel could fail suddenly, causing a crash. Use only radial-ply tires with the wheels on your vehicle.

Uniform Tire Quality Grading

Quality grades can be found where applicable on the tire sidewall between tread shoulder and maximum section width. For example:

Treadwear 200 Traction AA Temperature A

The following information relates to the system developed by the United States National Highway Traffic Safety Administration, which grades tires by treadwear, traction and temperature performance. (This applies only to vehicles sold in the United States.)

The grades are molded on the sidewalls of most passenger car tires. The Uniform Tire Quality Grading system does not apply to deep tread, winter-type snow tires, space-saver or temporary use spare tires, tires with nominal rim diameters of 10 to 12 inches (25 to 30 cm), or to some limited-production tires.

While the tires available on General Motors passenger cars and light trucks may vary with respect to these grades, they must also conform to federal safety requirements and additional General Motors Tire Performance Criteria (TPC) standards.

Treadwear

The treadwear grade is a comparative rating based on the wear rate of the tire when tested under controlled conditions on a specified government test course. For example, a tire graded 150 would wear one and a half (1.5) times as well on the government course as a tire graded 100. The relative performance of tires depends upon the actual conditions of their use, however, and may depart significantly from the norm due to variations in driving habits, service practices and differences in road characteristics and climate.

Traction – AA, A, B, C

The traction grades, from highest to lowest, are AA, A, B, and C. Those grades represent the tire's ability to stop on wet pavement as measured under controlled conditions on specified government test surfaces of asphalt and concrete. A tire marked C may have poor traction performance. Warning: The traction grade assigned to this tire is based on straight-ahead braking traction tests, and does not include acceleration, cornering, hydroplaning, or peak traction characteristics.

Temperature – A, B, C

The temperature grades are A (the highest), B, and C, representing the tire's resistance to the generation of heat and its ability to dissipate heat when tested under controlled conditions on a specified indoor laboratory test wheel. Sustained high temperature can cause the material of the tire to degenerate and reduce tire life, and excessive temperature can lead to sudden tire failure. The grade C corresponds to a level of performance which all passenger car tires must meet under the Federal Motor Vehicle Safety Standard No. 109. Grades B and A represent higher levels of performance on the laboratory test wheel than the minimum required by law.

Warning: The temperature grade for this tire is established for a tire that is properly inflated and not overloaded. Excessive speed, underinflation, or excessive loading, either separately or in combination, can cause heat buildup and possible tire failure.

Wheel Alignment and Tire Balance

The wheels on your vehicle were aligned and balanced carefully at the factory to give you the longest tire life and best overall performance.

Scheduled wheel alignment and wheel balancing are not needed. However, if you notice unusual tire wear or your vehicle pulling one way or the other, the alignment may need to be reset. If you notice your vehicle vibrating when driving on a smooth road, your wheels may need to be rebalanced.

Wheel Replacement

Replace any wheel that is bent, cracked, or badly rusted or corroded. If wheel nuts keep coming loose, the wheel, wheel bolts and wheel nuts should be replaced. If the wheel leaks air, replace it (except some aluminum wheels, which can sometimes be repaired). See your dealer if any of these conditions exist.

Your dealer will know the kind of wheel you need.

Each new wheel should have the same load-carrying capacity, diameter, width, offset and be mounted the same way as the one it replaces.

If you need to replace any of your wheels, wheel bolts or wheel nuts, replace them only with new GM original equipment parts. This way, you will be sure to have the right wheel, wheel bolts and wheel nuts for your vehicle.

 **CAUTION:**

Using the wrong replacement wheels, wheel bolts or wheel nuts on your vehicle can be dangerous. It could affect the braking and handling of your vehicle, make your tires lose air and make you lose control. You could have a collision in which you or others could be injured. Always use the correct wheel, wheel bolts and wheel nuts for replacement.

Notice: The wrong wheel can also cause problems with bearing life, brake cooling, speedometer or odometer calibration, headlamp aim, bumper height, vehicle ground clearance and tire clearance to the body and chassis.

 **CAUTION:**

Rust or dirt on a wheel, or on the parts to which it is fastened, can make wheel nuts become loose after a time. The wheel could come off and cause a crash. When you change a wheel, remove any rust or dirt from places where the wheel attaches to the vehicle. In an emergency, you can use a cloth or a paper towel to do this; but be sure to use a scraper or wire brush later, if you need to, to get all the rust or dirt off.

 **CAUTION:**

Never use oil or grease on studs or the threads of the wheel nuts. If you do, the wheel nuts might come loose and the wheel could fall off, causing a crash.

 **CAUTION:**

Incorrect wheel nuts or improperly tightened wheel nuts can cause the wheel to become loose and even come off. This could lead to a crash. Be sure to use the correct wheel nuts. If you have to replace them, be sure to get new GM original equipment wheel nuts.

Notice: Improperly tightened wheel nuts can lead to brake pulsation and rotor damage. To avoid expensive brake repairs, evenly tighten the wheel nuts in the proper sequence and to the proper torque specification.

Magnesium Wheels

Notice: If your vehicle has magnesium wheels, moisture on or around the mounting surface of the magnesium wheel will cause corrosion and damage to the wheel. To help prevent this, a magnesium wheel uses two rubber O-rings. One goes on the inboard side of the wheel and the other on the back of the center hubcap. When you put a magnesium wheel back on, be sure the O-rings are correctly installed. On the inboard side, of the wheel, work the O-ring into the groove. When properly installed, this O-ring fits snugly. The other O-ring goes around the retaining legs of the center cap.

Used Replacement Wheels

 **CAUTION:**

Putting a used wheel on your vehicle is dangerous. You can't know how it's been used or how far it's been driven. It could fail suddenly and cause a crash. If you have to replace a wheel, use a new GM original equipment wheel.

Tire Chains

CAUTION:

Don't use tire chains. There's not enough clearance. Tire chains used on a vehicle without the proper amount of clearance can cause damage to the brakes, suspension or other vehicle parts. The area damaged by the tire chains could cause you to lose control of your vehicle and you or others may be injured in a crash. Use another type of traction device only if its manufacturer recommends it for use on your vehicle and tire size combination and road conditions. Follow that manufacturer's instructions. To help avoid damage to your vehicle, drive slowly, readjust or remove the device if it's contacting your vehicle, and don't spin your wheels. If you do find traction devices that will fit, install them on the rear tires.

Lifting Your Vehicle

CAUTION:

Lifting a vehicle can cause an injury. The vehicle can slip off the jack and roll over you or other people. You and they could be badly injured. Find a level place to lift your vehicle.

To help prevent the vehicle from moving:

1. Set the parking brake firmly.
2. Put an automatic transmission shift lever in PARK (P), or shift a manual transmission to FIRST (1) or REVERSE (R).
3. Turn off the engine.

To be even more certain the vehicle won't move, you can put blocks in front of and behind the wheels.

 **CAUTION:**

Getting under a vehicle when it is jacked up is dangerous. If the vehicle slips off the jack, you could be badly injured or killed. Never get under a vehicle when it is supported only by a jack.

 **CAUTION:**

Raising your vehicle with the jack improperly positioned can damage the vehicle and even make the vehicle fall. To help avoid personal injury and vehicle damage, be sure to place the jack in the proper location before raising the vehicle.

If you ever use a jack to lift your Corvette, such as to display it at a show, follow the instructions that came with the jack, and be sure to use the correct lifting points to avoid damaging your vehicle.

Notice: Lifting your vehicle improperly can damage your vehicle and result in costly repairs not covered by your warranty. To lift your vehicle properly, follow the advice in this part.

To help prevent vehicle damage:

- Be sure to place a block or pad between the jack and the vehicle.
- Make sure the jack you're using spans at least two crossmember ribs.
- Lift only in the areas shown in the following pictures.

For additional information, see your dealer and the Chevrolet Corvette service manual.

Lifting From the Front

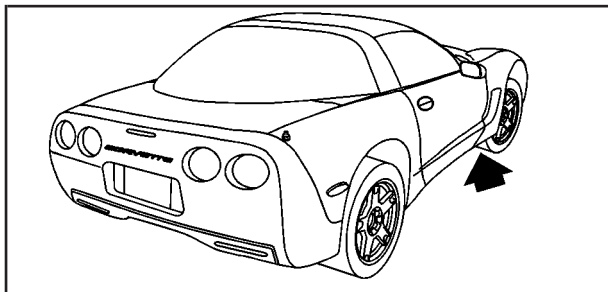

The front lifting point can be accessed for either the driver's or passenger's side of the vehicle, behind the front tires.

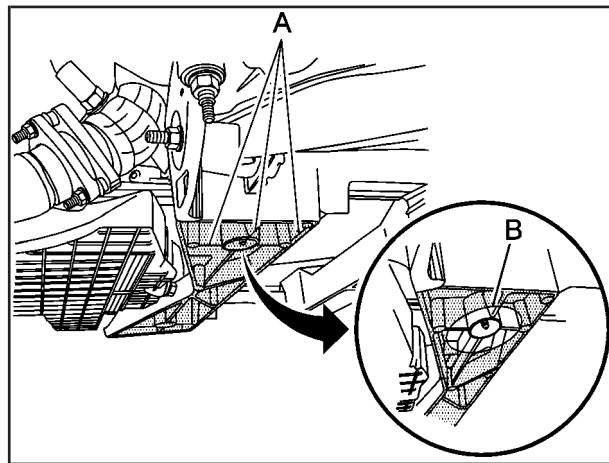

1. Locate the lifting point (B) on either side of your vehicle to jack the vehicle according to the illustration shown.
2. Be sure to place a block or pad between the jack and the vehicle.
3. Lift the vehicle with the jack, making sure the jack spans at least two of the crossmember ribs (A).

Lifting From the Rear

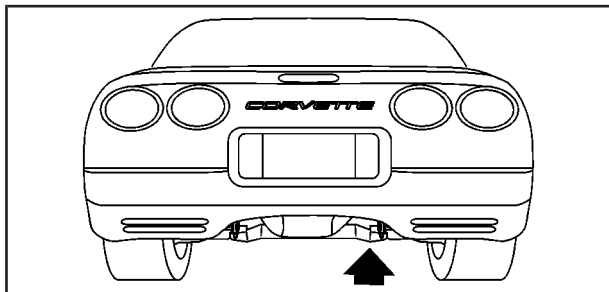

The rear lifting point can be accessed from the rear of the vehicle, on either the driver's or passenger's side.

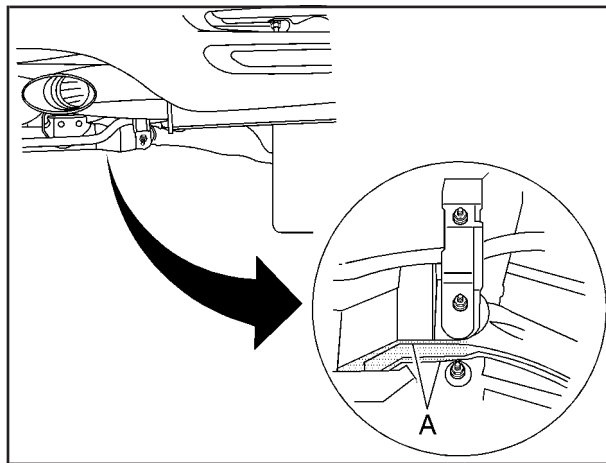

1. Locate the lifting point to jack your vehicle according to the illustration shown.
2. Be sure to place a block or pad between the jack and the vehicle.
3. Lift the vehicle with the jack, making sure the jack spans at least two of the crossmember ribs.

For more information, see *Doing Your Own Service Work* on page 5-3.

If a Tire Goes Flat

Your Corvette has no spare tire, no tire changing equipment and no place to store a tire.

It's unusual for a tire to "blow out" while you're driving, especially if you maintain your tires properly. See *Tires on page 5-55*. If air goes out of a tire, it's much more likely to leak out slowly.

If your vehicle has Extended Mobility Tires (EMT), you won't need to stop on the side of the road to change a flat tire. EMT tires can operate effectively with no air pressure. If you drive on a deflated EMT for 50 miles (80 km) or less and at speeds of 55 mph (90 km/h) or less, there is a good chance that the tire can be repaired. Contact the nearest authorized Chevrolet or Goodyear EMT servicing facility, as soon as possible, to have the flat tire inspected and repaired or replaced. For more information, see *Extended Mobility Tires (Except Z06) on page 5-61*.

CAUTION:

Special tools and procedures are required to service an Extended Mobility Tire (EMT). If these special tools and procedures aren't used you or others could be injured and your vehicle could be damaged. Always be sure the proper tools and procedures, as described in the service manual, are used.

To order a service manual, see *Service Publications Ordering Information on page 7-11*.

Z06 models do not have Extended Mobility Tires. If a Z06 model tire goes flat, avoid further tire and wheel damage by driving slowly to a level place and stopping. Then do this:

1. Turn on the hazard warning flashers.
2. Set the parking brake firmly.
3. Put the shift lever (manual transmission) in REVERSE (R).
4. Turn off the engine.
5. Inspect the flat tire.

If the tire has been separated from the wheel or has damaged sidewalls or large tears that allow rapid air loss, call a tire repair facility. See *Roadside Assistance Program on page 7-6*.

If the flat tire is due to a slow leak caused by a nail or other similar road hazard, the tire inflator kit may be used to repair the damaged tire temporarily. The kit uses a liquid tire sealant to seal small punctures in the

tread area of the tire. The flat tire is then inflated to at least 26 psi (179 kPa) and driven to evenly distribute the tire sealant. The tire pressure is checked after driving for a maximum of 10 minutes to see if the slow leak has been stopped. If the tire pressure is 19 psi (131 kPa) or more, inflate the tire up to the standard operating pressure as shown on the Tire Pressure Label found on the rear edge of the driver's door. See *Inflation - Tire Pressure on page 5-62*.

You should have the damaged tire repaired as soon as possible. The tire sealant is a temporary repair only. For more information regarding the tire inflator kit see "Tire Inflator Kit (Z06 Only)" following this section.

Notice: If the tire pressure has dropped below 19 psi (131 kPa), the vehicle should not be driven further. Damage to the tire may be severe and the sealant will not be effective. Contact Roadside Assistance. See "Roadside Assistance" in the Index.

Tire Inflator Kit (Z06 Only)

Every Z06 model with P295/35ZR18 and P265/40ZR17 tires, when new, was equipped with a tire inflator kit. The repair kit contains a detailed instruction card that outlines step by step the temporary repair procedure. Be sure to read and follow all the tire inflator kit instructions. The kit also includes:

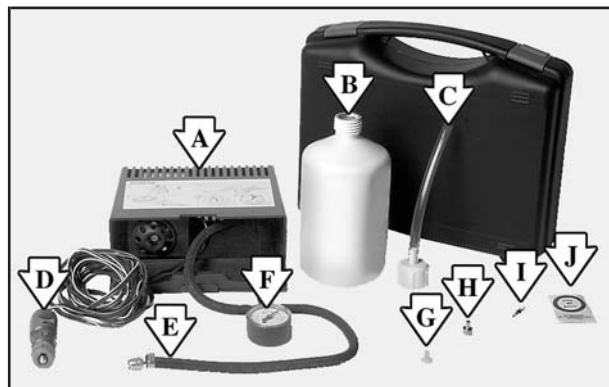

- | | |
|-------------------------------------|---------------------------------|
| A. Air Compressor | F. Air Pressure Gage |
| B. Tire Sealant | G. Sealant Filling
Hose Plug |
| C. Sealant Filling Hose | H. Valve Core Remover |
| D. Air Compressor
Accessory Plug | I. Spare Valve Core |
| E. Air Compressor
Inflator Hose | J. 55-mph Label |

Tire Sealant

The kit contains a liquid sealant that when injected into a flat tire, may temporarily repair nail holes or cuts in the tread area of the tire. The tire sealant cannot repair tire damage caused while driving on a flat tire or a tire that has had a “blow out” or a tire that has punctures in the sidewall areas. The tire sealant solution is a one-time use application for one tire only. Check the tire sealant expiration date; the sealant may not be as effective beyond the expiration date. The tire sealant can be peeled off easily after drying.

Notice: Do not use a tire sealant if your vehicle is equipped with Extended Mobility Tires or tire pressure monitors. The tire sealant can damage tire pressure monitor sensors. See “Extended Mobility Tires” in the Index.

Air Compressor

The air compressor included in the tire inflator kit, was designed exclusively for the Z06 Model equipped with P295/35ZR18 and P265/40ZR17 tires. After the sealant has been injected into the flat tire, use the air compressor to inflate the tire to at least 26 psi (179 kPa). Instructions for connecting and using the air compressor are located on the air compressor.

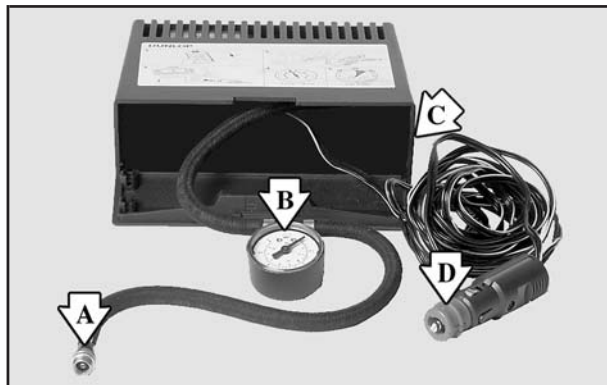

- A. Inflating Hose
- B. Air Pressure Gage
- C. ON/OFF Switch
- D. Air Compressor Plug

Notice: The car engine must be running to avoid draining the battery while running the air compressor.

Follow the proper steps to be sure your vehicle will not move. See *Parking Your Vehicle (Manual Transmission)* on page 2-35.

 **CAUTION:**

It can be dangerous to get out of your vehicle with the engine running, if the shift lever is not in NEUTRAL (N) with the parking brake firmly set (manual transmission). Your vehicle can roll or move suddenly even when on fairly level ground. To be sure your vehicle won't move, always set your parking brake and move the shift lever to NEUTRAL (N) when you start or idle your engine.

 **CAUTION:**

Idling the engine in a closed-in place or with the climate control system off can cause deadly carbon monoxide (CO). See "Engine Exhaust" in the Index.

 **CAUTION:**

Inflating something too much can make it explode, and you or others could be injured. Be sure to read the inflator instructions, and inflate the tire to its recommended pressure. Do not exceed 36 psi (248 kPa).

Notice: Do not allow the air compressor to operate continuously for more than six minutes to help prevent damage from overheating.

Notice: If 26 psi (179 kPa) tire pressure cannot be reached after six minutes the vehicle should not be driven further. Damage to the tire is severe and the sealant will not be effective. Remove the air compressor plug from the accessory power outlet and unscrew the inflating hose from the tire valve. See "Roadside Assistance" in the Index.

If 26 psi (179 kPa) tire pressure is reached in six minutes or less, disconnect the air compressor and attach the enclosed maximum speed label to the inside upper left corner of the windshield or to the face of the radio/clock.



The maximum speed label reminds you to drive cautiously and not to exceed 55 mph (90 km/h) until you have the damaged tire inspected and repaired.

Place the air compressor pump and accessories into the inflator kit case and store in the hatch/trunk compartment area of your vehicle.

Tire Inflator Kit Storage

The tire inflator kit is stored in the rear hatch/trunk area of your vehicle.

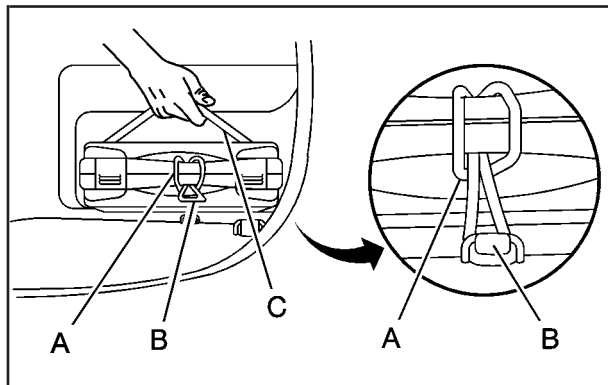

1. Remove the elastic cord (A) from around the retaining hook (B) and slide the kit out from under the elastic band (C) that is secured to the floor of the hatch/trunk area.

- Unwrap the elastic cord (A) from around the handle of the tire inflator kit. Open the tire inflator kit case by lifting up the two tabs located on either side of the kit handle.

To Stow the Tire Inflator Kit:

CAUTION:

Storing the tire inflator kit or other equipment in the passenger compartment of the vehicle could cause injury. In a sudden stop or collision, loose equipment could strike someone. Store the tire inflator kit in the proper place.

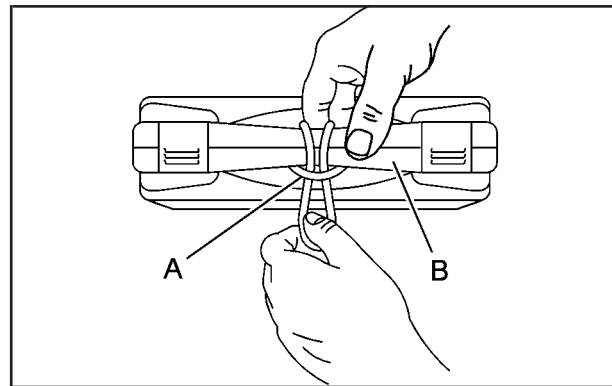

- Loop the elastic cord (A) around the handle of the tire inflator kit.

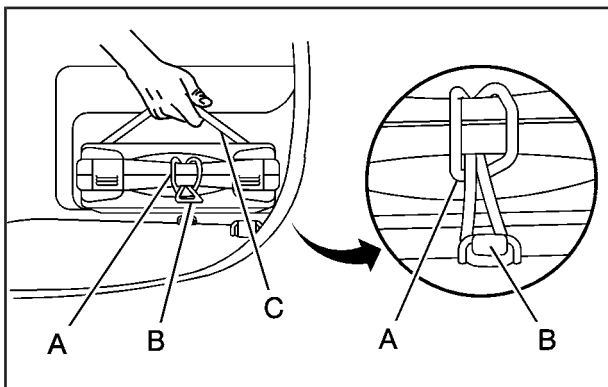

2. Insert the tire inflator kit under the elastic band (C) that is secured to the floor of the hatch/trunk area of your vehicle.
3. Wrap the elastic cord (A) around the retaining hook (B).

Appearance Care

Remember, cleaning products can be hazardous. Some are toxic. Others can burst into flames if you strike a match or get them on a hot part of the vehicle. Some are dangerous if you breathe their fumes in a closed space. When you use anything from a container to clean your vehicle, be sure to follow the manufacturer's warnings and instructions. And always open your doors or windows when you are cleaning the inside.

Never use these to clean your vehicle:

- Gasoline
- Benzene
- Naphtha
- Carbon Tetrachloride
- Acetone
- Paint Thinner
- Turpentine
- Lacquer Thinner
- Nail Polish Remover

They can all be hazardous — some more than others — and they can all damage your vehicle, too.

Do not use any of these unless this manual says you can. In many uses, these will damage your vehicle:

- Alcohol
- Laundry Soap
- Bleach
- Reducing Agents

Cleaning the Inside of Your Vehicle

Use a vacuum cleaner often to get rid of dust and loose dirt. Wipe vinyl, leather, plastic and painted surfaces with a clean, damp cloth.

Cleaning Fabric/Carpet

Your dealer has cleaners for the cleaning of fabric and carpet. They will clean normal spots and stains very well.

You can get GM-approved cleaning products from your dealer. See *Vehicle Care/Appearance Materials on page 5-90*.

Here are some cleaning tips:

- Always read the instructions on the cleaner label.
- Clean up stains as soon as you can – before they set.
- Carefully scrape off any excess stain.
- Use a clean cloth or sponge, and change to a clean area often. A soft brush may be used if stains are stubborn.
- If a ring forms on fabric after spot cleaning, clean the entire area immediately or it will set.

Cleaning Coated Moldings

These moldings are around the hatch opening in the rear area.

- When lightly soiled, wipe with a sponge or soft lint-free cloth dampened with water.
- When heavily soiled, use warm soapy water.

Cleaning Leather

Use a soft cloth with lukewarm water and a mild soap or saddle soap and wipe dry with a soft cloth. Then, let the leather dry naturally. Do not use heat to dry.

- For stubborn stains, use a leather cleaner.
- Never use oils, varnishes, solvent-based or abrasive cleaners, furniture polish or shoe polish on leather.
- Soiled or stained leather should be cleaned immediately. If dirt is allowed to work into the finish, it can harm the leather.

Cleaning the Top of the Instrument Panel

Use only mild soap and water to clean the top surfaces of the instrument panel. Sprays containing silicones or waxes may cause annoying reflections in the windshield and even make it difficult to see through the windshield under certain conditions.

Cleaning Interior Plastic Components

Use only a mild soap and water solution on a soft cloth or sponge. Commercial cleaners may affect the surface finish.

Cleaning the Security Shade and Convenience Net

Wash with warm water and mild detergent, rinse with cold water and tumble dry on low. Do not use chlorine bleach.

Cleaning Glass Surfaces

Glass should be cleaned often. GM Glass Cleaner or a liquid household glass cleaner will remove normal tobacco smoke and dust films on interior glass. See *Vehicle Care/Appearance Materials on page 5-90*.

Notice: If you use abrasive cleaners when cleaning glass surfaces on your vehicle, you could scratch the glass and/or cause damage to the rear window defogger and the integrated radio antenna. When cleaning the glass on your vehicle, use only a soft cloth and glass cleaner.

Care of Safety Belts

Keep belts clean and dry.

CAUTION:

Do not bleach or dye safety belts. If you do, it may severely weaken them. In a crash, they might not be able to provide adequate protection. Clean safety belts only with mild soap and lukewarm water.

Weatherstrips

Silicone grease on weatherstrips will make them last longer, seal better, and not stick or squeak. Apply silicone grease with a clean cloth at least every six months. During very cold, damp weather more frequent application may be required. See *Recommended Fluids and Lubricants on page 6-11*.

Cleaning the Outside of Your Vehicle

The paint finish on your vehicle provides beauty, depth of color, gloss retention and durability.

Washing Your Vehicle

The best way to preserve your vehicle's finish is to keep it clean by washing it often with lukewarm or cold water.

Do not wash your vehicle in the direct rays of the sun. Use a car washing soap. Do not use strong soaps or chemical detergents. Be sure to rinse the vehicle well, removing all soap residue completely. You can get GM-approved cleaning products from your dealer. See *Vehicle Care/Appearance Materials on page 5-90*. Do not use cleaning agents that are petroleum based, or that contain acid or abrasives. All cleaning agents should be flushed promptly and not allowed to dry on the surface, or they could stain. Dry the finish with a soft, clean chamois or an all-cotton towel to avoid surface scratches and water spotting.

High pressure car washes may cause water to enter your vehicle.

Notice: If you drive your vehicle through an automatic car wash that does not have enough clearance for the undercarriage and/or wide rear tires, you could damage your vehicle. Verify with the manager of the car wash that your vehicle will fit before entering the car wash or use a touchless car wash.

Cleaning Exterior Lamps/Lenses

Use only lukewarm or cold water, a soft cloth and a car washing soap to clean exterior lamps and lenses. Follow previous instructions under “Washing Your Vehicle.”

Finish Care

Occasional waxing or mild polishing of your vehicle by hand may be necessary to remove residue from the paint finish. You can get GM-approved cleaning products from your dealer. See *Vehicle Care/Appearance Materials on page 5-90*.

Your vehicle has a “basecoat/clearcoat” paint finish. The clearcoat gives more depth and gloss to the colored basecoat. Always use waxes and polishes that are non-abrasive and made for a basecoat/clearcoat paint finish.

Notice: Machine compounding or aggressive polishing on a basecoat/clearcoat paint finish may damage it. Use only non-abrasive waxes and polishes that are made for a basecoat/clearcoat paint finish on your vehicle.

Foreign materials such as calcium chloride and other salts, ice melting agents, road oil and tar, tree sap, bird droppings, chemicals from industrial chimneys, etc., can damage your vehicle’s finish if they remain on painted surfaces. Wash the vehicle as soon as possible. If necessary, use non-abrasive cleaners that are marked safe for painted surfaces to remove foreign matter.

Exterior painted surfaces are subject to aging, weather and chemical fallout that can take their toll over a period of years. You can help to keep the paint finish looking new by keeping your vehicle garaged or covered whenever possible.

Cleaning Windshield and Wiper Blades

If the windshield is not clear after using the windshield washer, or if the wiper blade chatters when running, wax, sap or other material may be on the blade or windshield.

Clean the outside of the windshield with a full-strength glass cleaning liquid. The windshield is clean if beads do not form when you rinse it with water.

If you use a glass treatment or conditioner containing ethyl alcohol or ethyl sulfate on your glass, be sure to remove the acrylic roof panel, if so equipped. These products may damage the panel.

Grime from the windshield will stick to the wiper blades and affect their performance. Clean the blade by wiping vigorously with a cloth soaked in full-strength windshield washer solvent. Then rinse the blade with water.

Check the wiper blades and clean them as necessary; replace blades that look worn.

Cleaning Removable Roof Panel

Special care is necessary when cleaning, removing and/or storing the roof panel.

- Flush with water to remove dust and dirt, then dry the panel.
- Clean the panel with GM Glass Cleaner. Leave the cleaner on the panel for one minute, then wipe the panel with a soft, lint-free cloth.
- Do not use abrasive cleaning materials

If water drops are frequently allowed to dry on roof panel, impurities in the water will adhere to the top. These impurities may etch or mar the finish. When the panel gets wet, you should dry it off.

Notice: If you use a glass treatment and/or conditioner that contains ethyl alcohol or ethyl sulfate on the roof panel, you could damage the panel. The repairs would not be covered by your warranty. Only use a GM-approved glass cleaner on the roof panel.

Cleaning the Convertible Top

Your convertible top should be cleaned often. If you use an automatic car wash, use one with water jets and hanging cloths. High pressure car washes may cause water to enter your vehicle.

When you hand wash the top, do it in partial shade. Use a mild soap, lukewarm water and a soft sponge. A chamois or cloth may leave lint on the top, and a brush can chafe the threads in the top fabric. Do not use detergents, harsh cleaners, solvents or bleaching agents.

Wet the entire vehicle and wash the top evenly to avoid spots or rings. Let the soap remain on the fabric for a few minutes. When the top is really dirty, use a mild foam-type cleaner. Your dealer has a Convertible Top Cleaner and Water Repellent. Thoroughly rinse the entire vehicle, then let the top dry in direct sunlight.

To protect the convertible top:

- After you wash the vehicle, make sure the top is completely dry before you lower it.
- Do not get any cleaner on the vehicle's painted finish; it could leave streaks.
- If you decide to go through an automatic car wash, ask the manager if the equipment could damage your top.

Cleaning Aluminum Wheels

Keep your wheels clean using a soft clean cloth with mild soap and water. Rinse with clean water. After rinsing thoroughly, dry with a soft clean towel. A wax may then be applied.

The surface of these wheels is similar to the painted surface of your vehicle. Do not use strong soaps, chemicals, abrasive polishes, abrasive cleaners, cleaners with acid, or abrasive cleaning brushes on them because you could damage the surface. Do not use chrome polish on aluminum wheels.

Do not take your vehicle through an automatic car wash that has silicone carbide tire cleaning brushes. These brushes can also damage the surface of these wheels.

Cleaning Tires

To clean your tires, use a stiff brush with tire cleaner.

Notice: Using petroleum-based tire dressing products on your vehicle may damage the paint finish and/or tires. When applying a tire dressing, always wipe off any overspray from all painted surfaces on your vehicle.

Finish Damage

Any stone chips, fractures or deep scratches in the finish should be repaired right away.

Minor chips and scratches can be repaired with touch-up materials available from your dealer or other service outlets. Larger areas of finish damage can be corrected in your dealer's body and paint shop.

Carbon Fiber Hood (Z06 Commemorative Edition Model Only)

The hood on the Z06 Commemorative Edition model is made from an advanced carbon fiber composite. Under certain lighting conditions, the carbon fiber has a faint woven appearance and can be seen through the paint, but not felt. It is most obvious when viewing the reflection of an object in the surface of the hood. The edges of the object in the reflection will appear slightly jagged, due to the woven carbon fiber material. This is normal. No special care is needed.

Magnesium Wheel Finish

Notice: Improper paint repair or refinishing can cause corrosion damage to a magnesium wheel. See your dealer if a magnesium wheel needs paint repair or refinishing.

Underbody Maintenance

Chemicals used for ice and snow removal and dust control can collect on the underbody. If these are not removed, corrosion and rust can develop on the underbody parts such as fuel lines, frame, floor pan and exhaust system even though they have corrosion protection.

At least every spring, flush these materials from the underbody with plain water. Clean any areas where mud and debris can collect. Dirt packed in close areas of the frame should be loosened before being flushed. Your dealer or an underbody car washing system can do this for you.

Titanium Exhaust System (Z06 Only)

Time and high performance driving conditions can cause a color change in titanium exhaust system parts. This is normal for a titanium surface.

Fiberglass Springs

Notice: If you use acidic or corrosive cleaning products, engine degreasers or aluminum cleaning agents on fiberglass springs, you may damage the springs. The repairs would not be covered by your warranty. Use only approved cleaners when cleaning your vehicle's fiberglass springs.

Chemical Paint Spotting

Some weather and atmospheric conditions can create a chemical fallout. Airborne pollutants can fall upon and attack painted surfaces on your vehicle. This damage can take two forms: blotchy, ring-shaped discolorations, and small, irregular dark spots etched into the paint surface.

Although no defect in the paint job causes this, GM will repair, at no charge to the owner, the surfaces of new vehicles damaged by this fallout condition within 12 months or 12,000 miles (20 000 km) of purchase, whichever occurs first.

Vehicle Care/Appearance Materials

See your GM dealer for more information on purchasing the following products.

Vehicle Care/Appearance Materials

Description	Usage
Polishing Cloth Wax-Treated	Interior and exterior polishing cloth.
Tar and Road Oil Remover	Removes tar, road oil and asphalt.
Chrome Cleaner and Polish	Use on chrome or stainless steel.
White Sidewall Tire Cleaner	Removes soil and black marks from whitewalls.
Vinyl Cleaner	Cleans vinyl tops, upholstery and convertible tops.
Glass Cleaner	Removes dirt, grime, smoke and fingerprints.
Chrome and Wire Wheel Cleaner	Removes dirt and grime from chrome wheels and wire wheel covers.
Finish Enhancer	Removes dust, fingerprints, and surface contaminants. Spray on wipe off.

Vehicle Care/Appearance Materials (cont'd)

Description	Usage
Swirl Remover Polish	Removes swirl marks, fine scratches and other light surface contamination.
Cleaner Wax	Removes light scratches and protects finish.
Foaming Tire Shine Low Gloss	Cleans, shines and protects in one easy step, no wiping necessary.
Wash Wax Concentrate	Medium foaming shampoo. Cleans and lightly waxes. Biodegradable and phosphate free.
Spot Lifter	Quickly and easily removes spots and stains from carpets, vinyl and cloth upholstery.
Odor Eliminator	Odorless spray odor eliminator used on fabrics, vinyl, leather and carpet.
See your General Motors parts department for these products. See <i>Recommended Fluids and Lubricants</i> on page 6-11.	

Vehicle Identification

Vehicle Identification Number (VIN)



This is the legal identifier for your vehicle. It appears on a plate in the front corner of the instrument panel, on the driver's side. You can see it if you look through the windshield from outside your vehicle. The VIN also appears on the Vehicle Certification and Service Parts labels and the certificates of title and registration.

Engine Identification

The 8th character in your VIN is the engine code. This code will help you identify your engine, specifications and replacement parts.

Service Parts Identification Label

You will find this label located inside the glovebox. It is very helpful if you ever need to order parts. On this label is:

- your VIN,
- the model designation,
- paint information and
- a list of all production options and special equipment

Be sure that this label is not removed from the vehicle.

Electrical System

Add-On Electrical Equipment

Notice: Don't add anything electrical to your vehicle unless you check with your dealer first. Some electrical equipment can damage your vehicle and the damage wouldn't be covered by your warranty. Some add-on electrical equipment can keep other components from working as they should.

Your vehicle has an air bag system. Before attempting to add anything electrical to your vehicle, see *Servicing Your Air Bag-Equipped Vehicle on page 1-49.*

Headlamp Wiring

The headlamp wiring is protected by a circuit breaker. An electrical overload will cause the lamps to go on and off, or in some cases to remain off. If this happens, have your headlamp wiring checked right away.

Windshield Wiper Fuses

The windshield wiper motor is protected by a fuse and an internal circuit breaker. If the motor overheats due to heavy snow, etc., the wiper will stop until the motor cools. If the overload is caused by some electrical problem and not snow, etc., be sure to get it fixed.

Power Windows and Other Power Options

Circuit breakers protect the power seats and other power accessories. When the current load is too heavy, the circuit breaker opens and closes, protecting the circuit until the problem is fixed or goes away.

Fuses and Circuit Breakers

The wiring circuits in your vehicle are protected from short circuits by a combination of maxi-fuses, mini-fuses and circuit breakers. This greatly reduces the chance of fires caused by electrical problems.

Look at the silver-colored band inside the fuse. If the band is broken or melted, replace the fuse. Be sure you replace a bad fuse with a new one of the identical size and rating.

If you ever have a problem on the road and do not have a spare fuse, you can borrow one that has the same amperage. Just pick some feature of your vehicle that you can get along without – like the radio or cigarette lighter – and use its fuse, if it is the correct amperage. Replace it as soon as you can.

Instrument Panel Fuse Block



The instrument panel fuse block is located on the passenger's side of the vehicle, under the instrument panel and under the toe-board.

Remove the carpet and toe-board covering to access the fuse block by pulling at the top of each corner of the panel. Then turn the fuse block door knob counterclockwise and pull the door to access the fuses.

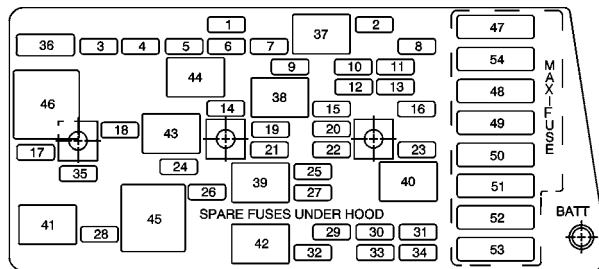

Fuse	Usage
8	Stoplamp, Hazard Flashers
9	Body Control Module
10	Windshield Wiper/Washer
11	Accessory Power
12	Blank
13	Body Control Module – Ignition 1
14	Crank
15	Hazard/Turn Signal
16	Air Bag
17	Tonneau Release
18	HVAC Controls
19	Instrument Panel Control
20	Cruise Control
21	Automatic Transmission Shift Lock Control System and Inside Rearview Mirror
22	Body Control Module – Ignition 3
23	Body Control Module – Ignition 2
24	Radio Antenna

Fuse	Usage
1	Console Cigarette Lighter
2	Monitored (Inadvertent) Load Control
3	Lumbar Seat
4	Driver Seat Control Module
5	Radio, Compact Disc Player
6	Parking Lamps, Taillamps
7	Cigarette Lighter

Fuse	Usage
25	Body Control Module – Ignition 1 Instrument Panel Control
26	Hatch/Trunk Release
27	HVAC Controls
28	Bose Speakers
29	Diagnostic
30	Right Door Control Module
31	Power Feed Door Right
32	Fuel Tank Door
33	Door Control Module Left
34	Power Feed Door Left
47	Ignition 1
48	Rear Defogger
49	Blank
50	Ignition 2
51	Blower Motor
52	Starter
53	Blank

Relay	Usage
37	Monitored (Inadvertent) Load Control
38	Right Daytime Running Lamp
39	Hatch/Trunk Release
40	Left Daytime Running Lamp
41	Tonneau Release
42	Courtesy Lamps
43	Automatic Lamp Control Parking Lamps
44	Automatic Lamp Control Headlamps
45	Bose Speakers
46	Rear Defogger

Circuit Breaker	Usage
35	Driver Power Seat
36	Passenger Power Seat
54	Headlamps

Engine Compartment Fuse Block



There is one fuse block in the engine compartment located on the passenger's side of the vehicle in front of the battery.

To remove the fuse block cover, turn the knob counterclockwise.

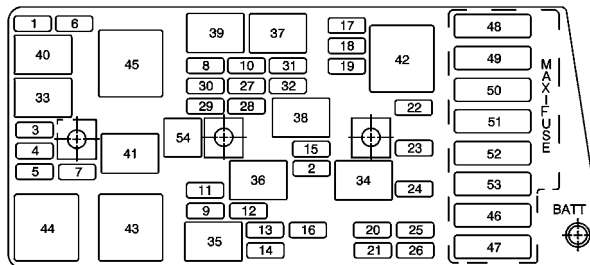

Fuse	Usage
1	Rear Fog Lamp
2	Approach
3	Right Headlamp Motor
4	Left Headlamp Motor
5	Anti-Lock Brakes, Selective Ride Control
6	Fog Lamp
7	Blank

Fuse	Usage
8	Headlamp Low-Beam Right
9	Headlamp High-Beam Right
10	Headlamp Low-Beam Left
11	Horn
12	Headlamp High-Beam Left
13	Fuel Pump
14	Cooling Fan – Ignition 3
15	Oxygen Sensor
16	Powertrain Control Module
17	Throttle Control
18	Injector 2
19	Engine Ignition
20	Blank
21	Blank
22	Injector 1
23	Powertrain Control Module
24	Air Conditioning

Fuse	Usage
25	Blank
26	Blank
27	Spare
28	Spare
29	Spare
30	Spare
31	Spare
32	Spare
46	Cooling Fan 2
47	Blank
48	Blank
49	Cooling Fan 1
50	Air Pump
51	Selective Ride Control
52	Anti-Lock Brakes
53	Anti-Lock Brakes Electronics
54	Fuse Puller

Relay	Usage
33	Air Pump
34	Air Conditioner and Clutch
35	Fuel Pump
36	Horn
37	Rear Fog Lamp
38	Back-Up Lamps
39	Fog Lamp

Relay	Usage
40	Blank
41	Blank
42	Ignition 1
43	Cooling Fan 2
44	Cooling Fan 3
45	Cooling Fan 1

Capacities and Specifications

The following approximate capacities are given in English and metric conversions.

Please refer to *Recommended Fluids and Lubricants* on page 6-11 for more information.

Capacities and Specifications

Application	Capacities	
	English	Metric
Air Conditioning Refrigerant R134a	1.75 lbs	0.79 kg
Automatic Transmission		
Drain and Refill	5.0 quarts	4.7 L
Overhaul	10.8 quarts	10.2 L
Cooling System	12.6 quarts	11.9 L
Engine Oil with Filter	6.5 quarts	6.1 L
Fuel Tank	18.0 gallons	68.0 L
Manual Transmission (Overhaul)	4.1 quarts	3.8 L
Wheel Nut Torque	100 lb ft	140 N•m
All capacities are approximate. When adding, be sure to fill to the appropriate level, as recommended in this manual. Recheck fluid level after filling		

Engine Specifications

Engine	VIN Code	Transmission	Spark Plug Gap	Firing Order
LS1 V8	G	Automatic	0.040 inch (1.016 mm)	1-8-7-2-6-5-4-3
LS1 V8	G	Manual	0.040 inch (1.016 mm)	1-8-7-2-6-5-4-3
LS6 V8	S	Manual	0.040 inch (1.016 mm)	1-8-7-2-6-5-4-3

Engine Data

Engine	Horsepower	Torque	Displacement	Compression Ratio
LS1 Automatic Transmission	350 @ 5200 rpm	360 lb ft @ 4000 rpm	5.7 L	10.1:1
LS1 Manual Transmission	350 @ 5200 rpm	375 lb ft @ 4400 rpm	5.7 L	10.1:1
LS6	405 @ 6000 rpm	400 lb ft @ 4800 rpm	5.7 L	10.5:1

Section 6 Maintenance Schedule

Maintenance Schedule	6-2	Owner Checks and Services	6-8
Introduction	6-2	At Each Fuel Fill	6-8
Maintenance Requirements	6-2	At Least Once a Month	6-9
Your Vehicle and the Environment	6-2	At Least Once a Year	6-9
Using Your Maintenance Schedule	6-2	Recommended Fluids and Lubricants	6-11
Scheduled Maintenance	6-4	Normal Maintenance Replacement Parts	6-13
Additional Required Services	6-6	Engine Drive Belt Routing	6-14
Maintenance Footnotes	6-7	Maintenance Record	6-15

Maintenance Schedule

Introduction

Important: Keep engine oil at the proper level and change as recommended.



Have you purchased the GM Protection Plan? The Plan supplements your new vehicle warranties. See your Warranty and Owner Assistance booklet or your dealer for details.

Maintenance Requirements

Notice: Maintenance intervals, checks, inspections, replacement parts and recommended fluids and lubricants as prescribed in this manual are necessary to keep your vehicle in good working condition. Any damage caused by failure to follow scheduled maintenance may not be covered by warranty.

Your Vehicle and the Environment

Proper vehicle maintenance not only helps to keep your vehicle in good working condition, but also helps the environment. All recommended maintenance is important. Improper vehicle maintenance can even affect the quality of the air we breathe. Improper fluid levels or the wrong tire inflation can increase the level of emissions from your vehicle. To help protect our environment, and to keep your vehicle in good condition, be sure to maintain your vehicle properly.

Using Your Maintenance Schedule

We at General Motors want to help you keep your vehicle in good working condition. But we do not know exactly how you will drive it. You may drive very short distances only a few times a week. Or you may drive long distances all the time in very hot, dusty weather. You may use your vehicle in making deliveries. Or you may drive it to work, to do errands or in many other ways.

Because of all the different ways people use their vehicles, maintenance needs vary. You may need more frequent checks and replacements. So please read the following and note how you drive. If you have any questions on how to keep your vehicle in good condition, see your GM Goodwrench dealer.

This schedule is for vehicles that:

- carry passengers and cargo within recommended limits. You will find these limits on the tire and loading information label. See *Loading Your Vehicle* on page 4-33.
- are driven on reasonable road surfaces within legal driving limits.
- use the recommended fuel. See *Gasoline Octane* on page 5-4.

The services in *Scheduled Maintenance* on page 6-4 should be performed when indicated. See *Additional Required Services* on page 6-6 and *Maintenance Footnotes* on page 6-7 for further information.

 **CAUTION:**

Performing maintenance work on a vehicle can be dangerous. In trying to do some jobs, you can be seriously injured. Do your own maintenance work only if you have the required know-how and the proper tools and equipment for the job. If you have any doubt, see your GM Goodwrench dealer to have a qualified technician do the work.

Some maintenance services can be complex. So, unless you are technically qualified and have the necessary equipment, you should have your GM Goodwrench dealer do these jobs.

When you go to your GM Goodwrench dealer for your service needs, you will know that GM-trained and supported service technicians will perform the work using genuine GM parts.

If you want to get service information, see *Service Publications Ordering Information* on page 7-11.

Owner Checks and Services on page 6-8 tells you what should be checked, when to check it and what you can easily do to help keep your vehicle in good condition.

The proper replacement parts, fluids and lubricants to use are listed in *Recommended Fluids and Lubricants* on page 6-11 and *Normal Maintenance Replacement Parts* on page 6-13. When your vehicle is serviced, make sure these are used. All parts should be replaced and all necessary repairs done before you or anyone else drives the vehicle. We recommend the use of genuine GM parts.

Scheduled Maintenance

When the CHANGE OIL SOON message comes on, it means that service is required for your vehicle. Have your vehicle serviced as soon as possible within the next 600 miles (1 000 km). It is possible that, if you are driving under the best conditions, the engine oil life system may not indicate that vehicle service is necessary for over a year. However, your engine oil and filter must be changed at least once a year and at this time the system must be reset. Your GM Goodwrench dealer has GM-trained service technicians who will perform this work using genuine GM parts and reset the system.

If the engine oil life system is ever reset accidentally, you must service your vehicle within 3,000 miles (5 000 km) since your last service. Remember to reset the oil life system whenever the oil is changed. See *Engine Oil on page 5-13* for information on the Engine Oil Life System and resetting the system.

When the CHANGE OIL SOON message appears, certain services, checks and inspections are required. Required services are described in the following for “Maintenance I” and “Maintenance II.” Generally, it is recommended that your first service be Maintenance I, your second service be Maintenance II and that you alternate Maintenance I and Maintenance II thereafter. However, in some cases, Maintenance II may be required more often.

Maintenance I — Use Maintenance I if the message comes on within ten months since vehicle was purchased or Maintenance II was performed.

Maintenance II — Use Maintenance II if the previous service performed was Maintenance I. Always use Maintenance II whenever the message comes on ten months or more since the last service or if the message has not come on at all for one year.

Scheduled Maintenance

Service	Maintenance I	Maintenance II
Change engine oil and filter. Reset oil life system. See <i>Engine Oil on page 5-13. An Emission Control Service.</i>	•	•
Visually check for any leaks or damage. See <i>footnote (g).</i>	•	•
Inspect engine air cleaner filter. If necessary, replace filter. See <i>Engine Air Cleaner/Filter on page 5-18. An Emission Control Service. See footnote †.</i>	•	•
Check tire inflation pressures and tire wear. See <i>Tires on page 5-55.</i>	•	•
Inspect brake system. See <i>footnote (a).</i>	•	•
Check engine coolant and windshield washer fluid levels and add fluid as needed.	•	•
Perform any needed additional services. See “Additional Required Services” in this section.	•	•
Inspect suspension and steering components. See <i>footnote (b).</i>		•
Inspect engine cooling system. See <i>footnote (c).</i>		•
Inspect wiper blades. See <i>footnote (d).</i>		•
Inspect restraint system components. See <i>footnote (e).</i>		•
Lubricate body components. See <i>footnote (f).</i>		•

Additional Required Services

The following services should be performed at the first maintenance service (I or II) after the indicated miles (kilometers) shown for each item.

Additional Required Services

Service	25,000 (41 500)	50,000 (83 000)	75,000 (125 000)	100,000 (166 000)	125,000 (207 500)	150,000 (240 000)
Inspect fuel system for damage or leaks.	•	•	•	•	•	•
Inspect exhaust system for loose or damaged components.	•	•	•	•	•	•
Change automatic transmission fluid and filter (severe service). <i>See footnote (h).</i>		•		•		•
Change automatic transmission fluid and filter (normal service).				•		
Replace spark plugs and inspect spark plug wires. <i>An Emission Control Service.</i>				•		
Engine cooling system service (or every 5 years, whichever occurs first). <i>An Emission Control Service.</i> <i>See footnote (i).</i>						•
Inspect engine accessory drive belt. <i>An Emission Control Service.</i>						•

Maintenance Footnotes

† The U.S. Environmental Protection Agency or the California Air Resources Board has determined that the failure to perform this maintenance item will not nullify the emission warranty or limit recall liability prior to the completion of the vehicle's useful life. We, however, urge that all recommended maintenance services be performed at the indicated intervals and the maintenance be recorded.

(a) Visually inspect brake lines and hoses for proper hook-up, binding, leaks, cracks, chafing, etc. Inspect disc brake pads for wear and rotors for surface condition. Inspect other brake parts, including calipers, parking brake, etc.

(b) Visually inspect front and rear suspension and steering system for damaged, loose or missing parts or signs of wear. Inspect power steering lines and hoses for proper hook-up, binding, leaks, cracks, chafing, etc.

(c) Visually inspect hoses and have them replaced if they are cracked, swollen or deteriorated. Inspect all pipes, fittings and clamps; replace with genuine GM parts as needed. To help ensure proper operation, a pressure test of the cooling system and pressure cap and cleaning the outside of the radiator and air conditioning condenser is recommended at least once a year.

(d) Visually inspect wiper blades for wear or cracking. Replace blade inserts that appear worn or damaged or that streak or miss areas of the windshield.

(e) Make sure the safety belt reminder light and all your belts, buckles, latch plates, retractors and anchorages are working properly. Look for any other loose or damaged safety belt system parts. If you see anything that might keep a safety belt system from doing its job, have it repaired. Have any torn or frayed safety belts replaced. Also look for any opened or broken air bag coverings, and have them repaired or replaced. (The air bag system does not need regular maintenance.)

(f) Lubricate all key lock cylinders and body door hinges. Lubricate all hinges and latches, including those for the hood, rear compartment, console door and any folding seat hardware. More frequent lubrication may be required when exposed to a corrosive environment. Applying silicone grease on weatherstrips with a clean cloth will make them last longer, seal better and not stick or squeak.

(g) A fluid loss in any vehicle system could indicate a problem. Have the system inspected and repaired and the fluid level checked. Add fluid if needed.

(h) *Change automatic transmission fluid and filter if the vehicle is mainly driven under one or more of these conditions:*

- *In heavy city traffic where the outside temperature regularly reaches 90°F (32°C) or higher.*
- *In hilly or mountainous terrain.*
- *Uses such as high performance operation.*

(i) *Drain, flush and refill cooling system. See Engine Coolant on page 5-23 for what to use. Inspect hoses. Clean radiator, condenser, pressure cap and filler neck. Pressure test the cooling system and pressure cap.*

Owner Checks and Services

These owner checks and services should be performed at the intervals specified to help ensure the safety, dependability and emission control performance of your vehicle. Your GM Goodwrench dealer can assist you with these checks and services.

Be sure any necessary repairs are completed at once. Whenever any fluids or lubricants are added to your vehicle, make sure they are the proper ones, as shown in *Recommended Fluids and Lubricants on page 6-11*.

At Each Fuel Fill

It is important to perform these underhood checks at each fuel fill.

Engine Oil Level Check

Check the engine oil level and add the proper oil if necessary. See *Engine Oil on page 5-13* for further details.

Notice: It is important to check your oil regularly and keep it at the proper level. Failure to keep your engine oil at the proper level can cause damage to your engine not covered by your warranty.

Engine Coolant Level Check

Check the engine coolant level and add DEX-COOL[®] coolant mixture if necessary. See *Engine Coolant on page 5-23* for further details.

Windshield Washer Fluid Level Check

Check the windshield washer fluid level in the windshield washer tank and add the proper fluid if necessary.

At Least Once a Month

Tire Inflation Check

Visually inspect your tires and make sure tires are inflated to the correct pressures. See *Tires on page 5-55* for further details.

Cassette Tape Player Service

Clean cassette tape player. Cleaning should be done every 50 hours of tape play. See *Audio System(s) on page 3-69* for further details.

Power Antenna Service

Clean power antenna mast. See *Audio System(s) on page 3-69* for further details.

At Least Once a Year

Starter Switch Check

**CAUTION:**

When you are doing this inspection, the vehicle could move suddenly. If the vehicle moves, you or others could be injured.

1. Before you start, be sure you have enough room around the vehicle.
2. Firmly apply both the parking brake and the regular brake. See *Parking Brake on page 2-31* if necessary. Do not use the accelerator pedal, and be ready to turn off the engine immediately if it starts.
3. On automatic transmission vehicles, try to start the engine in each gear. The starter should work only in PARK (P) or NEUTRAL (N). If the starter works in any other position, contact your GM Goodwrench dealer for service.
4. On manual transmission vehicles, put the shift lever in NEUTRAL (N), push the clutch pedal down halfway and try to start the engine. The starter should work only when the clutch pedal is pushed down all the way to the floor. If the starter works when the clutch is not pushed all the way down, contact your GM Goodwrench dealer for service.

Automatic Transmission Shift Lock Control System Check

CAUTION:

When you are doing this inspection, the vehicle could move suddenly. If the vehicle moves, you or others could be injured.

1. Before you start, be sure you have enough room around the vehicle. It should be parked on a level surface.
2. Firmly apply the parking brake. See *Parking Brake* on page 2-31 if necessary.
Be ready to apply the regular brake immediately if the vehicle begins to move.
3. With the engine off, turn the key to the ON position, but do not start the engine. Without applying the regular brake, try to move the shift lever out of PARK (P) with normal effort. If the shift lever moves out of PARK (P), contact your GM Goodwrench dealer for service.

Ignition Automatic Transmission Lock Check

While parked, and with the parking brake set, try to turn the ignition key to OFF in each shift lever position.

- The key should turn to OFF only when the shift lever is in PARK (P).
- The key should come out only in OFF.

Contact your GM Goodwrench dealer if service is required.

Parking Brake and Automatic Transmission Park (P) Mechanism Check

CAUTION:

When you are doing this check, your vehicle could begin to move. You or others could be injured and property could be damaged. Make sure there is room in front of your vehicle in case it begins to roll. Be ready to apply the regular brake at once should the vehicle begin to move.

Park on a fairly steep hill, with the vehicle facing downhill. Keeping your foot on the regular brake, set the parking brake.

- To check the parking brake's holding ability: With the engine running and transmission in NEUTRAL (N), slowly remove foot pressure from the regular brake pedal. Do this until the vehicle is held by the parking brake only.
- To check the PARK (P) mechanism's holding ability: With the engine running, shift to PARK (P). Then release the parking brake followed by the regular brake.

Contact your GM Goodwrench dealer if service is required.

Underbody Flushing Service

At least every spring, use plain water to flush any corrosive materials from the underbody. Take care to clean thoroughly any areas where mud and other debris can collect.

Recommended Fluids and Lubricants

Fluids and lubricants identified below by name, part number or specification may be obtained from your dealer.

Usage	Fluid/Lubricant
Engine Oil	The engine requires a special engine oil meeting GM Standard GM4718M. Oils meeting this standard may be identified as synthetic, and should also be identified with the American Petroleum Institute Certified for Gasoline Engines starburst symbol. However, not all synthetic API oils with the starburst symbol will meet this GM standard. You should look for and use only an oil that meets GM Standard GM4718M. For the proper viscosity, see <i>Engine Oil on page 5-13</i> .
Engine Coolant	50/50 mixture of clean, drinkable water and use only DEX-COOL [®] Coolant. See <i>Engine Coolant on page 5-23</i> .

Usage	Fluid/Lubricant
Hydraulic Brake System	Delco Supreme 11 Brake Fluid or equivalent DOT-3 brake fluid.
Windshield Washer Solvent	GM Optikleen® Washer Solvent.
Hydraulic Clutch System	Hydraulic Clutch Fluid (GM Part No. U.S. 12345347, in Canada 10953517) or equivalent DOT-3 brake fluid.
Power Steering System	GM Power Steering Fluid (GM Part No. U.S. 89021184, in Canada 89021186).
Manual Transmission	DEXRON®-III Automatic Transmission Fluid.
Automatic Transmission	DEXRON®-III Automatic Transmission Fluid.
Key Lock Cylinders	Multi-Purpose Lubricant, Superlube (GM Part No. U.S. 12346241, in Canada 10953474).

Usage	Fluid/Lubricant
Rear Axle (Limited-Slip Differential)	SAE 75W-90 Synthetic Axle Lubricant (GM Part No. U.S. 12378261, in Canada 10953455) meeting GM Specification 9986115. With a complete drain and refill add 4 ounces (118 ml) of Limited-Slip Axle Lubricant Additive (GM Part No. U.S. 1052358, in Canada 992694) where required. See <i>Rear Axle on page 5-47</i> .
Hood Latch Assembly, Secondary Latch, Pivots, Spring Anchor and Release Pawl	Lubriplate Lubricant Aerosol (GM Part No. U.S. 12346293, in Canada 992723) or lubricant meeting requirements of NLGI #2, Category LB or GC-LB.
Hood and Door Hinges	Multi-Purpose Lubricant, Superlube (GM Part No. U.S. 12346241, in Canada 10953474).
Weatherstrip Conditioning	Dielectric Silicone Grease (GM Part No. U.S. 12345579, in Canada 992887).

Normal Maintenance Replacement Parts

Replacement parts identified below by name, part number, or specification can be obtained from your dealer.

Part	GM Part Number	AC Delco® Part Number
Engine Air Cleaner/Filter	25042562	A917C
Engine Oil Filter	25010633	PF44
PCV Valve	25179136	CV948C
Spark Plug	12571164	41-985
Windshield Wiper Blade (Shepherd's Hook Type) 22 inches (55.9 cm)	22143943	—

Engine Drive Belt Routing

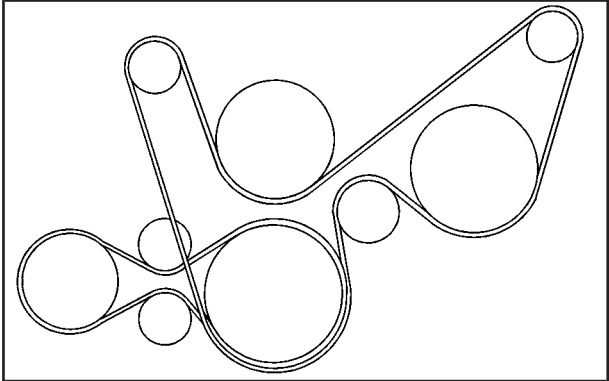

Maintenance Record

After the scheduled services are performed, record the date, odometer reading, who performed the service and the type of services performed in the boxes provided. See *Maintenance Requirements on page 6-2* in this section. Any additional information from *Owner Checks and Services on page 6-8* can be added on the following record pages. Also, you should retain all maintenance receipts.

Maintenance Record

Date	Odometer Reading	Serviced By	Maintenance I or Maintenance II	Services Performed

Maintenance Record (cont'd)

Date	Odometer Reading	Serviced By	Maintenance I or Maintenance II	Services Performed

Section 7 Customer Assistance and Information

Customer Assistance and Information	7-2	Reporting Safety Defects	7-10
Customer Satisfaction Procedure	7-2	Reporting Safety Defects to the United States	
Online Owner Center	7-3	Government	7-10
Customer Assistance for Text Telephone		Reporting Safety Defects to the Canadian	
(TTY) Users	7-4	Government	7-11
Customer Assistance Offices	7-4	Reporting Safety Defects to	
GM Mobility Program for Persons with		General Motors	7-11
Disabilities	7-5	Service Publications Ordering Information	7-11
Roadside Assistance Program	7-6		
Courtesy Transportation	7-7		
Vehicle Data Collection and Event Data			
Records	7-9		

Customer Assistance and Information

Customer Satisfaction Procedure

Your satisfaction and goodwill are important to your dealer and to Chevrolet. Normally, any concerns with the sales transaction or the operation of your vehicle will be resolved by your dealer's sales or service departments. Sometimes, however, despite the best intentions of all concerned, misunderstandings can occur. If your concern has not been resolved to your satisfaction, the following steps should be taken:

STEP ONE: Discuss your concern with a member of dealership management. Normally, concerns can be quickly resolved at that level. If the matter has already been reviewed with the sales, service or parts manager, contact the owner of the dealership or the general manager.

STEP TWO: If after contacting a member of dealership management, it appears your concern cannot be resolved by the dealership without further help, contact the Chevrolet Customer Assistance Center by calling 1-800-222-1020. In Canada, contact GM of Canada Customer Communication Centre in Oshawa by calling 1-800-263-3777 (English) or 1-800-263-7854 (French).

We encourage you to call the toll-free number in order to give your inquiry prompt attention. Please have the following information available to give the Customer Assistance Representative:

- Vehicle Identification Number (This is available from the vehicle registration or title, or the plate at the top left of the instrument panel and visible through the windshield.)
- Dealership name and location
- Vehicle delivery date and present mileage

When contacting Chevrolet, please remember that your concern will likely be resolved at a dealer's facility. That is why we suggest you follow Step One first if you have a concern.

STEP THREE: Both General Motors and your dealer are committed to making sure you are completely satisfied with your new vehicle. However, if you continue to remain unsatisfied after following the procedure outlined in Steps One and Two, you should file with the BBB Auto Line Program to enforce any additional rights you may have. Canadian owners refer to your Warranty and Owner Assistance Information booklet for information on the Canadian Motor Vehicle Arbitration Plan (CAMVAP).

The BBB Auto Line Program is an out of court program administered by the Council of Better Business Bureaus to settle automotive disputes regarding vehicle repairs or the interpretation of the New Vehicle Limited Warranty. Although you may be required to resort to this informal dispute resolution program prior to filing a court action, use of the program is free of charge and your case will generally be heard within 40 days. If you do not agree with the decision given in your case, you may reject it and proceed with any other venue for relief available to you.

You may contact the BBB Auto Line Program using the toll-free telephone number or write them at the following address:

BBB Auto Line Program
Council of Better Business Bureaus, Inc.
4200 Wilson Boulevard
Suite 800
Arlington, VA 22203-1804
Telephone: 1-800-955-5100

This program is available in all 50 states and the District of Columbia. Eligibility is limited by vehicle age, mileage and other factors. General Motors reserves the right to change eligibility limitations and/or discontinue its participation in this program.

Online Owner Center

The Owner Center is a resource for your GM ownership needs. You can find your specific vehicle information all in one place.

The Owner Center allows you to:

- Get e-mail service reminders.
- Access information about your specific vehicle, including tips and videos and an electronic version of this owner's manual. (United States only)
- Keep track of your vehicle's service history and maintenance schedule.
- Find GM dealers for service nationwide.
- Receive special promotions and privileges only available to members. (United States only)

Refer to the web for updated information.

To register your vehicle, visit www.MyGMLink.com. (United States) or My GM Canada within www.gmcanada.com (Canada).

Customer Assistance for Text Telephone (TTY) Users

To assist customers who are deaf, hard of hearing, or speech-impaired and who use Text Telephones (TTYs), Chevrolet has TTY equipment available at its Customer Assistance Center. Any TTY user can communicate with Chevrolet by dialing: 1-800-833-CHEV (2438). (TTY users in Canada can dial 1-800-263-3830.)

Customer Assistance Offices

Chevrolet encourages customers to call the toll-free number for assistance. If a U.S. customer wishes to write to Chevrolet, the letter should be addressed to Chevrolet's Customer Assistance Center.

United States – Customer Assistance

Chevrolet Motor Division
Chevrolet Customer Assistance Center
P.O. Box 33170
Detroit, MI 48232-5170

1-800-222-1020
1-800-833-2438 (For Text Telephone devices (TTYs))
Roadside Assistance: 1-800-CHEV-USA® (243-8872)
Fax Number: 313-381-0022

From Puerto Rico:

1-800-496-9992 (English)
1-800-496-9993 (Spanish)
Fax Number: 313-381-0022

From U.S. Virgin Islands:

1-800-496-9994
Fax Number: 313-381-0022

Canada – Customer Assistance

General Motors of Canada Limited
Customer Communication Centre, 163-005
1908 Colonel Sam Drive
Oshawa, Ontario L1H 8P7

1-800-263-3777 (English)
1-800-263-7854 (French)
1-800-263-3830 (For Text Telephone devices (TTYs))
Roadside Assistance: 1-800-268-6800

Overseas – Customer Assistance

Please contact the local General Motors Business Unit.

Mexico, Central America and Caribbean Islands/Countries (Except Puerto Rico and U.S. Virgin Islands) – Customer Assistance

General Motors de Mexico, S. de R.L. de C.V.
Customer Assistance Center
Paseo de la Reforma # 2740
Col. Lomas de Bezares
C.P. 11910, Mexico, D.F.
01-800-508-0000
Long Distance: 011-52-53 29 0 800

GM Mobility Program for Persons with Disabilities



This program, available to qualified applicants, can reimburse you up to \$1,000 toward eligible aftermarket driver or passenger adaptive equipment you may require for your vehicle (hand controls, wheelchair/scooter lifts, etc.).

This program can also provide you with free resource information, such as area driver assessment centers and mobility equipment installers. The offer is available for a limited period of time from the date of vehicle purchase/lease. For more details, or to determine your vehicle's eligibility, see your GM dealer or call the GM Mobility Assistance Center at 1-800-323-9935. Text telephone (TTY) users, call 1-800-833-9935.

GM of Canada also has a Mobility Program. Call 1-800-GM-DRIVE (463-7483) for details. All TTY users call 1-800-263-3830.

Roadside Assistance Program

Security While You Travel

1-800-CHEV-USA (243-8872)

As the proud owner of a new Chevrolet vehicle, you are automatically enrolled in the Chevrolet Roadside Assistance program. This value-added service is intended to provide you with peace of mind as you drive in the city or travel the open road. Chevrolet's Roadside Assistance toll-free number is staffed by courteous and capable Roadside Assistance Representatives who are available 24 hours a day, 365 days a year.

We will provide the following services during the Bumper-to-Bumper warranty period, at no expense to you:

- **Fuel Delivery:** Delivery of enough fuel (\$5 maximum) for the customer to get to the nearest service station.
- **Lock-out Service (identification required):** Replacement keys or locksmith service will be covered at no charge if you are unable to gain entry into your vehicle. Delivery of the replacement key will be covered within 10 miles.
- **Emergency Tow:** Tow to the nearest dealership for warranty service or in the event of a vehicle-disabling accident. Assistance when the vehicle is mired in sand, mud or snow.

- **Flat Tire Change:** Installation of a spare tire will be covered at no charge. (The customer is responsible for the repair or replacement of the tire if not covered by a warrantable failure.)
- **Jump Start:** No-start occurrences which require a battery jump start will be covered at no charge.
- **Dealer Locator Service**

In many instances, mechanical failures are covered under Chevrolet's Bumper-to-Bumper warranty. However, when other services are utilized, our Roadside Assistance Representatives will explain any payment obligations you might incur.

For prompt and efficient assistance when calling, please provide the following to the Roadside Assistance Representative:

- Your name, home address, and home telephone number
- Telephone number of your location
- Location of the vehicle
- Model, year, color, and license plate number
- Mileage, Vehicle Identification Number and delivery date of the vehicle
- Description of the problem

While we hope you never have the occasion to use our service, it is added security while traveling for you and your family. Remember, we are only a phone call away. Chevrolet Roadside Assistance: 1-800-CHEV-USA (1-800-234-8872), text telephone (TTY) users, call 1-888-889-2438.

Chevrolet reserves the right to limit services or reimbursement to an owner or driver when, in Chevrolet's judgement, the claims become excessive in frequency or type of occurrence.

Roadside Assistance is not part of or included in the coverage provided by the New Vehicle Limited Warranty. Buick reserves the right to make any changes or discontinue the Roadside Assistance program at any time without notification.

Canadian Roadside Assistance

Vehicles purchased in Canada have an extensive roadside assistance program accessible from anywhere in Canada or the United States. Please refer to the Warranty and Owner Assistance Information book.

Courtesy Transportation

Chevrolet has always exemplified quality and value in its offering of motor vehicles. To enhance your ownership experience, we and our participating dealers are proud to offer Courtesy Transportation, a customer support program for new vehicles.

The Courtesy Transportation program is offered to retail purchase/lease customers in conjunction with the Bumper-to-Bumper coverage provided by the New Vehicle Limited Warranty. Several transportation options are available when warranty repairs are required. This will reduce your inconvenience during warranty repairs.

Plan Ahead When Possible

When your vehicle requires warranty service, you should contact your dealer and request an appointment. By scheduling a service appointment and advising your service consultant of your transportation needs, your dealer can help minimize your inconvenience.

If your vehicle cannot be scheduled into the service department immediately, keep driving it until it can be scheduled for service, unless, of course, the problem is safety-related. If it is, please call your dealership, let them know this, and ask for instructions.

If the dealer requests that you simply drop the vehicle off for service, you are urged to do so as early in the work day as possible to allow for same day repair.

Transportation Options

Warranty service can generally be completed while you wait. However, if you are unable to wait Chevrolet helps minimize your inconvenience by providing several transportation options. Depending on the circumstances, your dealer can offer you one of the following:

Shuttle Service

Participating dealers can provide you with shuttle service to get you to your destination with minimal interruption of your daily schedule. This includes a one way or round trip shuttle service to a destination up to 10 miles from the dealership.

Public Transportation or Fuel Reimbursement

If your vehicle requires overnight warranty repairs, reimbursement (five day maximum) may be available for the use of public transportation such as taxi or bus.

In addition, should you arrange transportation through a friend or relative, reimbursement for reasonable fuel expenses (five day maximum) may be available. Claim amounts should reflect actual costs and be supported by original receipts.

Courtesy Rental Vehicle

Your dealer may arrange to provide you with a courtesy rental vehicle or reimburse you for a rental vehicle you obtained if your vehicle is kept for a warranty repair. Reimbursement will be limited to a maximum of \$30.00 a day and must be supported by receipts. This requires that you sign and complete a rental agreement and meet state, local and rental vehicle provider requirements. Requirements vary and may include minimum age requirements, insurance coverage, credit card, etc. You are responsible for fuel usage charges and may also be responsible for taxes, levies, usage fees, excessive mileage or rental usage beyond the completion of the repair.

Generally it is not possible to provide a like-vehicle as a courtesy rental.

Additional Program Information

Courtesy Transportation is available during the Bumper-to-Bumper warranty coverage period, but it *is not* part of the New Vehicle Limited Warranty. A separate booklet entitled “Warranty and Owner Assistance Information” furnished with each new vehicle provides detailed warranty coverage information.

Courtesy Transportation is available only at participating dealers and all program options, such as shuttle service, may not be available at every dealer. Please contact your dealer for specific information about availability. All Courtesy Transportation arrangements will be administered by appropriate dealer personnel.

Canadian Vehicles: For warranty repairs during the Complete Vehicle Coverage period of the General Motors of Canada New Vehicle Limited Warranty, alternative transportation may be available under the Courtesy Transportation Program. Please consult your dealer for details.

General Motors reserves the right to unilaterally modify, change or discontinue Courtesy Transportation at any time and to resolve all questions of claim eligibility pursuant to the terms and conditions described herein at its sole discretion.

Vehicle Data Collection and Event Data Records

Your vehicle, like other modern motor vehicles, has a number of sophisticated computer systems that monitor and control several aspects of the vehicle’s performance. Your vehicle uses on-board vehicle computers to monitor emission control components to optimize fuel economy, to monitor conditions for airbag deployment and, if so equipped, to provide anti-lock braking and to help the driver control the vehicle in difficult driving situations. Some information may be stored during regular operations to facilitate repair of detected malfunctions; other information is stored only in a crash or near crash event by computer systems commonly called event data recorders (EDR).

In a crash or near crash event, computer systems, such as the Airbag Sensing and Diagnostic Module (SDM) in your vehicle may record information about the condition of the vehicle and how it was operated, such as engine speed, brake applications, throttle position, vehicle speed, seat belt usage, airbag readiness, airbag performance data, and the severity of a collision. This information has been used to improve vehicle crash performance and may be used to improve crash performance of future vehicles and driving safety. Unlike the data recorders on many airplanes, these on-board systems do not record sounds, such as conversation of vehicle occupants.

To read this information, special equipment is needed and access to the vehicle or the SDM is required. GM will not access information about a crash event or share it with others other than

- with the consent of the vehicle owner or, if the vehicle is leased, with the consent of the lessee,
- in response to an official request of police or similar government office,
- as part of GM's defense of litigation through the discovery process, or
- as required by law.

In addition, once GM collects or receives data, GM may

- use the data for GM research needs,
- make it available for research where appropriate confidentiality is to be maintained and need is shown, or
- share summary data which is not tied to a specific vehicle with non-GM organizations for research purposes.

Others, such as law enforcement, may have access to the special equipment that can read the information if they have access to the vehicle or SDM.

If your vehicle is equipped with OnStar, please check the OnStar subscription service agreement or manual for information on its operations and data collection.

Reporting Safety Defects

Reporting Safety Defects to the United States Government

If you believe that your vehicle has a defect which could cause a crash or could cause injury or death, you should immediately inform the National Highway Traffic Safety Administration (NHTSA), in addition to notifying General Motors.

If NHTSA receives similar complaints, it may open an investigation, and if it finds that a safety defect exists in a group of vehicles, it may order a recall and remedy campaign. However, NHTSA cannot become involved in individual problems between you, your dealer or General Motors.

To contact NHTSA, you may either call the Auto Safety Hotline toll-free at 1-800-424-9393 (or 366-0123 in the Washington, D.C. area) or write to:

NHTSA, U.S. Department of Transportation
Washington, D.C. 20590

You can also obtain other information about motor vehicle safety from the hotline.

Reporting Safety Defects to the Canadian Government

If you live in Canada, and you believe that your vehicle has a safety defect, you should immediately notify Transport Canada, in addition to notifying General Motors of Canada Limited. You may write to:

Transport Canada
330 Sparks Street
Tower C
Ottawa, Ontario K1A 0N5

Reporting Safety Defects to General Motors

In addition to notifying NHTSA (or Transport Canada) in a situation like this, we certainly hope you'll notify us. Please call us at 1-800-222-1020, or write:

Chevrolet Motor Division
Chevrolet Customer Assistance Center
P.O. Box 33170
Detroit, MI 48232-5170

In Canada, please call us at 1-800-263-3777 (English) or 1-800-263-7854 (French). Or, write:

General Motors of Canada Limited
Customer Communication Centre, 163-005
1908 Colonel Sam Drive
Oshawa, Ontario L1H 8P7

Service Publications Ordering Information

Service Manuals

Service Manuals have the diagnosis and repair information on engines, transmission, axle, suspension, brakes, electrical, steering, body, etc.

RETAIL SELL PRICE: \$120.00

Service Bulletins

Service Bulletins give technical service information needed to knowledgeably service General Motors cars and trucks. Each bulletin contains instructions to assist in the diagnosis and service of your vehicle.

In Canada, information pertaining to Product Service Bulletins can be obtained by contacting your General Motors dealer or by calling 1-800-GM-DRIVE (1-800-463-7483).

Owner's Information

Owner publications are written specifically for owners and intended to provide basic operational information about the vehicle. The owner's manual will include the Maintenance Schedule for all models.

In-Portfolio: Includes a Portfolio, Owner's Manual, and Warranty Booklet.

RETAIL SELL PRICE: \$60.00

Without Portfolio: Owner's Manual only.

RETAIL SELL PRICE: \$20.00

Current and Past Model Order Forms

Service Publications are available for current and past model GM vehicles. To request an order form, please specify year and model name of the vehicle.

ORDER TOLL FREE: 1-800-551-4123 Monday – Friday 8:00 AM - 6:00 PM Eastern Time

For Credit Card Orders Only
(VISA-MasterCard-Discover), visit Helm, Inc. on the
World Wide Web at: www.helminc.com

Or you can write to:

Helm, Incorporated
P. O. Box 07130
Detroit, MI 48207

Prices are subject to change without notice and without incurring obligation. Allow ample time for delivery.

Note to Canadian Customers: All listed prices are quoted in U.S. funds. Canadian residents are to make checks payable in U.S. funds.

A

Accessory Power Outlets	3-22
Activating the Theft-Deterrent Feature	3-86
Active Handling System	4-10
Active Handling System Light	3-40
Adding Washer Fluid	5-36
Additional Program Information	7-9
Additives, Fuel	5-6
Add-On Electrical Equipment	5-92
Adjusting the Speakers (Balance/Fade)	3-72, 3-78
Air Bag	
Off Light	3-36
Readiness Light	3-35
Air Bag System	1-40
Air Bag Off Switch	1-46
How Does an Air Bag Restrain?	1-44
Servicing Your Air Bag-Equipped Vehicle	1-49
What Makes an Air Bag Inflate?	1-43
What Will You See After an Air Bag Inflates?	1-44
When Should an Air Bag Inflate?	1-43
Where Are the Air Bags?	1-42
Air Cleaner/Filter, Engine	5-18
Air Compressor	5-78
Air Dam, Front	2-19
Airbag Sensing and Diagnostic Module (SDM)	7-9
AM	3-88
Antenna, Fixed Mast	3-89
Antenna, Power Antenna Mast Care	3-90
Antennas, Integrated Windshield and Rear Window	3-90
Anti-lock Brake System (ABS)	4-7
Anti-Lock Brake System Warning Light	3-39
Appearance Care	5-82
Care of Safety Belts	5-85
Chemical Paint Spotting	5-90
Cleaning the Inside of Your Vehicle	5-83
Cleaning the Outside of Your Vehicle	5-85
Fiberglass Springs	5-90
Finish Damage	5-89
Titanium Exhaust System	5-89
Underbody Maintenance	5-89
Vehicle Care/Appearance Materials	5-90
Weatherstrips	5-85
Arming the System	2-16
Ashtrays	3-23
Audio System(s)	3-69
Care of Your Cassette Tape Player	3-88
Care of Your CD Player	3-89
Care of Your CDs	3-89
Fixed Mast Antenna	3-89
Integrated Windshield and Rear Window Antennas	3-90
Power Antenna Mast Care	3-90
Radio with Cassette	3-70
Radio with CD	3-76
Setting the Time	3-69
Theft-Deterrent Feature	3-86

Audio System(s) (cont.)	
Trunk-Mounted CD Changer	3-81
Understanding Radio Reception	3-88
Automatic Transmission	2-21
Fluid	5-20
Operation	2-25

B

Battery	5-40
Battery Replacement	2-8
Battery Run-Down Protection	3-18
Before Leaving on a Long Trip	4-25
Brake	
Parking	2-31
System Warning Light	3-38
Brake Fluid	5-37
Brake Wear	5-39
Brakes	5-37
Braking	4-6
Braking in Emergencies	4-9
Break-In, New Vehicle	2-19
Bulb Replacement	5-48
Back-Up Lamps	5-52
Halogen Bulbs	5-48
Headlamps	5-48
Replacement Bulbs	5-52
Taillamps and Turn Signal Lamps	5-50
Buying New Tires	5-66

C

California Fuel	5-5
Canada – Customer Assistance	7-4
Canadian Owners	ii
Canadian Roadside Assistance	7-7
Capacities and Specifications	5-99
Carbon Fiber Hood	5-89
Carbon Monoxide	4-28, 4-38, 2-11, 2-36
Care of	
Safety Belts	5-85
Your Cassette Tape Player	3-88
Your CD Player	3-89
Your CDs	3-89
Cargo Cover	2-43
Cassette Tape Messages	3-75
Cassette Tape Player Service	6-9
CD Adapter Kits	3-75
CD Changer, Trunk-Mounted	3-81
CD Messages	3-80, 3-85
Center Console Storage Area	2-40
Chains, Tires	5-71
Check	
Engine Light	3-41
Gages Warning Light	3-46
Check Engine Light	3-41
Checking Coolant	5-24
Checking Engine Oil	5-13

Checking Things Under the Hood	5-10	Cleaning Interior Plastic Components	5-84
Checking Your Restraint Systems	1-49	Cleaning Leather	5-84
Chemical Paint Spotting	5-90	Cleaning Removable Roof Panel	5-87
Child Restraints		Cleaning the Convertible Top	5-88
Child Restraint Systems	1-25	Cleaning the Security Shade and	
Infants and Young Children	1-22	Convenience Net	5-84
Lower Anchorages and Top Tethers for		Cleaning the Top of the Instrument Panel	5-84
Children (LATCH System)	1-30	Cleaning Tires	5-88
Older Children	1-19	Cleaning Windshield and Wiper Blades	5-87
Securing a Child Restraint Designed for		Climate Control System	
the LATCH System	1-33	Dual Automatic	3-23
Securing a Child Restraint in the		Outlet Adjustment	3-31
Passenger Seat Position	1-36	Clutch, Hydraulic	5-22
Top Strap	1-28	Competitive Driving Mode	4-12
Top Strap Anchor Location	1-30	Control of a Vehicle	4-6
Cigarette Lighter	3-23	Convenience Net	2-43
Cleaning		Convertible Top	2-50
Fiberglass Springs	5-90	Lowering the Convertible Top	2-51
Inside of Your Vehicle	5-83	Raising the Convertible Top	2-55
Outside of Your Vehicle	5-85	Coolant	
Titanium Exhaust System	5-89	Engine Temperature Gage	3-41
Underbody Maintenance	5-89	Heater, Engine	2-23
Weatherstrips	5-85	Surge Tank Pressure Cap	5-26
Cleaning Aluminum Wheels	5-88	Cooling System	5-29
Cleaning Coated Moldings	5-83	Courtesy Lamps	3-17
Cleaning Exterior Lamps/Lenses	5-86	Cruise Control	3-10
Cleaning Fabric/Carpet	5-83	Cupholder(s)	2-40
Cleaning Glass Surfaces	5-84	Current and Past Model Order Forms	7-12

Customer Assistance Information	
Courtesy Transportation	7-7
Customer Assistance for Text	
Telephone (TTY) Users	7-4
Customer Assistance Offices	7-4
Customer Satisfaction Procedure	7-2
GM Mobility Program for Persons with	
Disabilities	7-5
Reporting Safety Defects to General Motors	7-11
Reporting Safety Defects to the Canadian	
Government	7-11
Reporting Safety Defects to the United States	
Government	7-10
Roadside Assistance Program	7-6
Service Publications Ordering Information	7-11

D

Daytime Running Lamps	3-15
Defensive Driving	4-2
Defogging and Defrosting	3-30
Disabling the Theft-Deterrent Feature	3-87
Disarming the System	2-17
Doing Your Own Service Work	5-3
Door	
Locks	2-9
Power Door Locks	2-10
Downshifting (Manual Transmission)	2-30

Driver	
Position, Safety Belt	1-12
Driver Information Center (DIC)	3-48
DIC Controls and Displays	3-49
DIC Warnings and Messages	3-58
Other Messages	3-68
Driving	
At Night	4-19
City	4-23
Defensive	4-2
Drunken	4-3
Freeway	4-24
Hill and Mountain Roads	4-26
In Rain and on Wet Roads	4-20
Winter	4-28
Driving On Snow or Ice	4-29
Driving Through Deep Standing Water	4-22
Driving Through Flowing Water	4-22
Dual Automatic Climate Control System	3-23

E

Electrical System	
Add-On Equipment	5-92
Fuses and Circuit Breakers	5-93
Headlamp Wiring	5-92
Power Windows and Other Power Options	5-92
Windshield Wiper Fuses	5-92

Emergency Trunk Release Handle (Convertible Only)	2-13
Emissions Inspection and Maintenance Programs	3-44
Engine	
Air Cleaner/Filter	5-18
Battery	5-40
Check and Service Engine Soon Light	3-41
Coolant	5-23
Coolant Heater	2-23
Coolant Temperature Gage	3-41
Drive Belt Routing	6-14
Engine Compartment Overview	5-12
Exhaust	2-36
Oil	5-13
Oil Pressure Gage	3-44
Overheating	5-26
Starting	2-21
Engine Compartment Fuse Block	5-96
Engine Oil Additives	5-16
Event Data Records (EDR)	7-9
Exit/Entry Lighting	3-17
Express-Down Window	2-15
Extended Mobility Tires (Except Z06)	5-61
Extender, Safety Belt	1-19
Exterior Lamps	3-13

F

Filter	
Engine Air Cleaner	5-18
Finding a Station	3-71, 3-77
Finish Care	5-86
Finish Damage	5-89
Fixed Mast Antenna	3-89
Flash-to-Pass	3-8
Flat Tire	5-75
Floor Mats	2-41
Fluid	
Automatic Transmission	5-20
Manual Transmission	5-21
Power Steering	5-35
Windshield Washer	5-36
FM	3-88
Fog Lamps	3-15
Front Air Dam	2-19
Fuel	5-4
Additives	5-6
California Fuel	5-5
Filling a Portable Fuel Container	5-10
Filling Your Tank	5-7
Fuels in Foreign Countries	5-6
Gage	3-46
Gasoline Octane	5-4
Gasoline Specifications	5-5

Fuses	
Fuses and Circuit Breakers	5-93
Windshield Wiper	5-92

G

Gage	
Check Gages Warning Light	3-46
Engine Coolant Temperature	3-41
Engine Oil Pressure	3-44
Fuel	3-46
Speedometer	3-34
Tachometer	3-34
Voltmeter Gage	3-37
Gasoline	
Octane	5-4
Specifications	5-5
Glove Box	2-40
GM Mobility Program for Persons with Disabilities	7-5

H

Hatch/Trunk	2-11
Hatch/Trunk Lid Release	2-12
Hazard Warning Flashers	3-4
Headlamp High/Low-Beam Changer	3-8

Headlamp Wiring	5-92
Headlamps	5-48
Bulb Replacement	5-48
Halogen Bulbs	5-48
Headlamps Doors	3-14
Headlamps on Reminder	3-8
Head-Up Display (HUD)	3-18
Highway Hypnosis	4-26
Hill and Mountain Roads	4-26
Hood	
Checking Things Under	5-10
Release	5-11
Hood, Carbon Fiber	5-89
Horn	3-5
How to Add Coolant to the Coolant Surge Tank	5-31
How to Add Fluid	5-22
How to Check	5-20, 5-21, 5-63
How to Check and Add Fluid	5-23
How to Check Lubricant	5-47
How to Check Power Steering Fluid	5-35
How to Remove and Replace the Floor Mats	2-41
How to Use This Manual	ii
How to Wear Safety Belts Properly	1-11
Hydraulic Clutch	5-22
Hydroplaning	4-22

I

If No Steam Is Coming From Your Engine	5-28
If Steam Is Coming From Your Engine	5-27
If the Light Is Flashing	3-42
If the Light Is On Steady	3-43
If You Are Caught in a Blizzard	4-30
If You Are Stuck in Sand, Mud, Ice or Snow	4-32
Ignition Positions	2-20
Infants and Young Children, Restraints	1-22
Inflation - Tire Pressure	5-62
Inflator Kit, Tire	5-77
Installing the Roof Panel	2-49
Instrument Panel	
Cluster	3-33
Overview	3-2
Instrument Panel Brightness	3-17
Instrument Panel Fuse Block	5-93
Integrated Windshield and Rear Window	
Antennas	3-90
Interior Lamps	3-17

J

Jump Starting	5-41
---------------------	------

K

Keyless Entry System	2-5
Keys	2-3

L

Lamps	
Exterior	3-13
Interior	3-17
Lap Belt Cinch Feature	1-13
Lap-Shoulder Belt	1-12
LATCH System	
Child Restraints	1-30
Securing a Child Restraint Designed for the LATCH System	1-33
Latches, Seatback	1-5
Leaving Your Vehicle	2-10
Leaving Your Vehicle With the Engine Running (Automatic Transmission)	2-33
Lifting From the Front	5-73
Lifting From the Rear	5-74
Lifting Your Vehicle, Tires	5-71
Light	
Active Handling System	3-40
Air Bag Off	3-36
Air Bag Readiness	3-35

Light (cont.)	
Anti-Lock Brake System Warning	3-39
Brake System Warning	3-38
Check Gages Warning	3-46
Malfunction Indicator	3-41
Safety Belt Reminder	3-34
Security	3-45
TCS Warning Light	3-39
Traction Control System (TCS) Warning	3-39
Lighted Visor Vanity Mirrors	2-15
Limited-Slip Rear Axle	4-12
Loading Your Vehicle	4-33
Lockout Protection	2-10
Locks	
Door	2-9
Leaving Your Vehicle	2-10
Lockout Protection	2-10
Power Door	2-10
Loss of Control	4-18
Lowering the Convertible Top	2-51

M

Magnesium Wheel Finish	5-89
Magnetic Speed Variable Assist Steering	4-14
Maintenance Schedule	
Additional Required Services	6-6
At Each Fuel Fill	6-8

Maintenance Schedule (cont.)	
At Least Once a Month	6-9
At Least Once a Year	6-9
Introduction	6-2
Maintenance Footnotes	6-7
Maintenance Record	6-15
Maintenance Requirements	6-2
Normal Maintenance Replacement Parts	6-13
Owner Checks and Services	6-8
Recommended Fluids and Lubricants	6-11
Scheduled Maintenance	6-4
Using Your	6-2
Your Vehicle and the Environment	6-2
Malfunction Indicator Light	3-41
Manual Seats	1-2
Manual Transmission	2-22
Fluid	5-21
Operation	2-28
Matching Transmitter(s) to Your Vehicle	2-7
Memory	2-57
Message	
DIC Warnings and Messages	3-58
Mexico, Central America and Caribbean Islands/ Countries (Except Puerto Rico and U.S. Virgin Islands) – Customer Assistance	7-5
Mirrors	
Automatic Dimming Rearview	2-38
Manual Rearview Mirror	2-37
Outside Automatic Dimming Mirror	2-39

Mirrors (cont.)	
Outside Convex Mirror	2-39
Outside Power Heated Mirrors	2-38
Model Reference	vi
MyGMLink.com	7-3

N

New Vehicle Break-In	2-19
Normal Maintenance Replacement Parts	6-13

O

Odometer	3-34
Off-Road Recovery	4-16
Oil	
Engine	5-13
Engine Oil Pressure Gage	3-44
Older Children, Restraints	1-19
One to Four Shift Light (Manual Transmission)	2-30
Online Owner Center	7-3
Operating the Trunk-Mounted CD Changer with the Radio with Cassette	3-83
Operating the Trunk-Mounted CD Changer with the Radio with CD	3-84
Other Warning Devices	3-5

Outlet Adjustment	3-31
Outside	
Automatic Dimming Mirror	2-39
Convex Mirror	2-39
Power Heated Mirrors	2-38
Overheated Engine Protection	
Operating Mode	5-26
Overseas – Customer Assistance	7-5
Owner Checks and Services	6-8
Owners, Canadian	ii
Owner's Information	7-12

P

Park (P)	
Shifting Into	2-32
Shifting Out of	2-34
Parking	
Brake	2-31
Over Things That Burn	2-35
Parking Your Vehicle	2-35
Passenger Position, Safety Belts	1-19
Passing	4-16
PASS-Key®	2-18
Plan Ahead When Possible	7-7
Playing a Cassette Tape	3-73
Playing a CD	3-79
Playing the Radio	3-70, 3-76

Power	
Accessory Outlets	3-22
Antenna Mast Care	3-90
Door Locks	2-10
Electrical System	5-92
Seat	1-2
Steering Fluid	5-35
Windows	2-15
Power Antenna Service	6-9
Power Steering	4-14

Q

Questions and Answers About Safety Belts	1-11
--	------

R

Racing or Other Competitive Driving	2-23
Radios	3-69
Care of Your Cassette Tape Player	3-88
Care of Your CD Player	3-89
Care of Your CDs	3-89
Radio with Cassette	3-70
Radio with CD	3-76
Setting the Time	3-69
Theft-Deterrent	3-86
Trunk-Mounted CD Changer	3-81
Understanding Reception	3-88

Raising the Convertible Top	2-55
Reading Lamps	3-18
Rear Axle	5-47
Limited-Slip	4-12
Rear Storage Area	2-42
Rear Window Defogger	3-31
Rearview Mirror, Automatic Dimming	2-38
Rearview Mirrors	2-37
Reclining Seatbacks	1-3
Recommended Fluids and Lubricants	6-11
Recreational Vehicle Towing	4-33
Remote Keyless Entry System	2-5
Remote Keyless Entry System Operation	2-6
Removing the Roof Panel	2-44
Replacement Bulbs	5-52
Replacing Brake System Parts	5-40
Replacing Restraint System Parts	
After a Crash	1-50
Reporting Safety Defects	
Canadian Government	7-11
General Motors	7-11
United States Government	7-10
Restraint System Check	
Checking Your Restraint Systems	1-49
Replacing Restraint System Parts	
After a Crash	1-50
Restraint Systems	
Checking	1-49
Replacing Parts	1-50

Retained Accessory Power (RAP)	2-21
Roadside	
Assistance Program	7-6
Rocking Your Vehicle To Get It Out	4-32
Roof Panel	2-44
Installing the Roof Panel	2-49
Removing the Roof Panel	2-44
Storing the Roof Panel	2-47
Routing, Engine Drive Belt	6-14
Running Your Engine While You Are Parked	2-36

S

Safety Belt	
Reminder Light	3-34
Safety Belts	
Care of	5-85
Driver Position	1-12
How to Wear Safety Belts Properly	1-11
Passenger Position	1-19
Questions and Answers About Safety Belts	1-11
Safety Belt Extender	1-19
Safety Belt Use During Pregnancy	1-18
Safety Belts Are for Everyone	1-6
Safety Warnings and Symbols	iii
Scheduled Maintenance	6-4
Seatback Latches	1-5

Seats	
Manual	1-2
Power Seats	1-2
Reclining Seatbacks	1-3
Seatback Latches	1-5
Sport Seat	1-6
Securing a Child Restraint	
Designed for the LATCH System	1-33
Passenger Seat Position	1-36
Security Light	3-45
Security While You Travel	7-6
Selective Ride Control	4-12
Sensors	3-29
Service	5-3
Adding Equipment to the Outside of Your	
Vehicle	5-4
Doing Your Own Work	5-3
Engine Soon Light	3-41
Publications Ordering Information	7-11
Service Bulletins	7-11
Service Manuals	7-11
Servicing Your Air Bag-Equipped Vehicle	1-49
Setting Preset Stations	3-71, 3-77
Setting the Time	3-69
Setting the Tone (Bass/Treble)	3-72, 3-78
Shift Speeds (Manual Transmission)	2-29
Shifting Into Park (P)	2-32
Shifting Out of Park (P)	2-34

Skidding	4-18
Some Other Rainy Weather Tips	4-22
Specifications, Capacities	5-99
Speedometer	3-34
Sport Seat	1-6
Starter Interlock Feature	2-23
Starting Your Engine	2-21
Steering	4-14
Steering in Emergencies	4-15
Steering Tips	4-14
Storage Areas	
Center Console Storage Area	2-40
Convenience Net	2-43
Cupholder(s)	2-40
Glove Box	2-40
Rear Storage Area	2-42
Storing the Roof Panel	2-47
Stuck in Sand, Mud, Ice or Snow	4-32
Sun Visors	2-15

T

Tachometer	3-34
Taillamps	
Turn Signal Lamps	5-50
TCS Warning Light	3-39
Telescopic Steering Column	3-6

Testing the Alarm	2-17
Theft-Deterrent, Radio	3-86
Theft-Deterrent System	2-16
Theft-Deterrent Systems	2-16
PASS-Key®	2-18
Tilt Wheel	3-5
Tire Inflation Check	6-9
Tire Inflator Kit Storage	5-80
Tire Sealant	5-78
Tire Sidewall Labeling	5-55
Tire Size Codes	5-57
Tire Terminology and Definitions	5-58
Tires	5-55
Buying New Tires	5-66
Chains	5-71
Extended Mobility (Except Z06)	5-61
If a Tire Goes Flat	5-75
Inflation - Tire Pressure	5-62
Lifting Your Vehicle	5-71
Pressure Monitor Operation (Except Z06)	5-64
Rotation	5-65
Tire Inflator Kit	5-77
Uniform Tire Quality Grading	5-67
Wheel Alignment and Tire Balance	5-68
Wheel Replacement	5-68
When It Is Time for New Tires	5-65
To Use The Engine Coolant Heater	2-24
Top Strap	1-28

Top Strap Anchor Location	1-30
Torque Lock (Automatic Transmission)	2-34
Towing	
Recreational Vehicle	4-33
Towing a Trailer	4-38
Your Vehicle	4-33
Traction	
Active Handling System	4-10
Control System (TCS)	4-9
Control System Warning Light	3-39
Limited-Slip Rear Axle	4-12
Selective Ride Control	4-12
Transmission	
Fluid, Automatic	5-20
Fluid, Manual	5-21
Transmission Operation, Automatic	2-25
Transmission Operation, Manual	2-28
Transportation Options	7-8
Trunk/Hatch	2-11
Trunk-Mounted CD Changer	3-81
Turn and Lane-Change Signals	3-7
Turn Signal/Multifunction Lever	3-6
Twilight Sentinel® (Optional in United States, Standard in Canada)	3-16

U

Understanding Radio Reception	3-88
Uniform Tire Quality Grading	5-67
United States – Customer Assistance	7-4
Unlocking the Theft-Deterrent Feature After a Power Loss	3-87

V

Vehicle	
Control	4-6
Damage Warnings	iv
Loading	4-33
Parking Your	2-35
Symbols	iv
Vehicle Data Collection and Event	
Data Records	7-9
Vehicle Identification	
Number (VIN)	5-91
Service Parts Identification Label	5-92
Vehicle Personalization	
Memory	2-57
Vehicle Storage	5-41
Ventilation Adjustment	3-31
Visors	2-15
Voltmeter Gage	3-37

W

Warning Lights, Gages and Indicators	3-32
Warnings	
DIC Warnings and Messages	3-58
Hazard Warning Flashers	3-4
Other Warning Devices	3-5
Safety and Symbols	iii
Vehicle Damage	iv
Washing Your Vehicle	5-85
What Kind of Engine Oil to Use	5-14
What to Do with Used Oil	5-17
What to Use	5-24, 5-35, 5-36, 5-47
Wheels	
Alignment and Tire Balance	5-68
Replacement	5-68
When to Add Engine Oil	5-14
When to Change Engine Oil (GM Oil Life System)	5-16

When to Check	5-21, 5-63
When to Check and What to Use	5-22
When to Check Lubricant	5-47
When to Check Power Steering Fluid	5-35
Why Safety Belts Work	1-8
Windows	2-14
Power	2-15
Windshield Washer	3-9
Fluid	5-36
Windshield Wiper	
Blade Replacement	5-52
Fuses	5-92
Windshield Wipers	3-8
Winter Driving	4-28

Y

Your Vehicle and the Environment	6-2
--	-----